



KIKUSUI

PART NO. IB021967
May 2019

Communication Interface Manual

Withstanding Voltage/
Insulation Resistance Tester

TOS5300

TOS5301

TOS5302

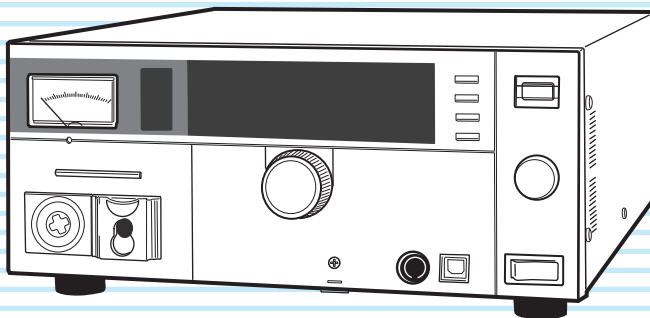

DANGER

This product generates high voltage!

- Improper operation can lead to serious accidents.
- To prevent accidents, be sure to read the section “Safety Precautions during Testing” in this manual.
- Keep this manual close to the product so that the operator can read it at any time.

Remote Control 5

Remote Control Overview 6

Message Overview 9

Message Overview 10

Command Reference 15

Command Description in This Manual 16

IEEE 488.2 Common Commands 17

Test Mode Settings 20

AC Withstanding Voltage Test (ACW) Conditions 21

DC Withstanding Voltage Test (DCW) Conditions 25

Insulation Resistance Test (IR) Conditions 29

About Sequences 33

Test Execution (SEquence2:TEST) 35

Querying Measured Values
(SEquence1:ACquire) 37

Various Settings 42

Status Register and Status Report Function 46

IEEE 488.2 Register Model 48

SCPI Register Model 50

Tutorial 58

Appendix 59

List of Messages 60

List of Errors 66

Default State 69

Command processing time 71

Using Visual Basic 2008 72

Thank you for purchasing the TOS5300 Series Withstanding Voltage and Insulation Resistance Tester.

About the Operation Manuals

There are five TOS5300 Series Manuals listed as follows.

■ Setup Guide

This manual is intended for first-time users of this product. It provides an overview of the product and notes on usage. It also explains how to set up the product for testing the DUT. Always read this manual before using the product.

■ Quick Reference

This manual explains Panel description and operation briefly.

■ Safety Information

This document contains general safety precautions for this product. Keep them in mind and make sure to observe them.

■ User's Manual (PDF)

This manual is intended for first-time users of this product. It provides an overview of the product and notes on usage. It also explains how to configure the product, operate the product, perform maintenance on the product, and so on.

■ Communication Interface Manual (this manual, PDF)

This manual contains details about remotely controlling the tester using SCPI commands. The interface manual is written for readers with sufficient basic knowledge of how to control measuring instruments using a PC.

PDF files are included in the accompanying CD-ROM. You can view the PDF files using Adobe Reader.

The newest version of the operation manual can be downloaded from Download service of Kikusui website.

TOS5300 Series Manuals are intended for users of the Withstanding Voltage and Insulation Resistance Tester and their instructors. Explanations are given under the presumption that the reader has knowledge about the electrical aspects of electrical safety testing.

Product firmware versions

This manual applies to products with ROM versions 1.2X.

When contacting us about the product, please provide us with:

- The model (marked in the top section of the front panel)
- The ROM version (see the user's manual)
- The serial number (marked in the bottom section of the rear panel)

Before reading this manual

First read the User's Manual, which includes information on the product's hardware, to avoid connecting or operating the product incorrectly.

Trademarks

Microsoft, Windows, and Visual Basic are registered trademarks of Microsoft Corporation in the United States and/or other countries.

All company names and product names used in this manual are trademarks or registered trademarks of their respective companies.

Copyrights

The contents of this manual may not be reproduced, in whole or in part, without the prior consent of the copyright holder.

The specifications of this product and the contents of this manual are subject to change without prior notice.

© 2010 Kikusui Electronics Corporation

Notations Used in This Manual

- The TOS5300 Series Withstanding Voltage and Insulation Resistance Tester is also referred to as the TOS5300 Series.
- Device under test is also referred to as DUT.
- The term "PC" is used to refer generally to both personal computers and workstations.
- The following markings are used in the explanations in the text.

NOTE

Indicates information that you should know.

See

Indicates a reference to detailed information.

>

Indicates menu settings that you select. The menu item to the left of the > symbol is a higher-level menu.

5300

Indicates a feature or message that is only available on the TOS5300 model.

5301

Indicates a feature or message that is only available on the TOS5301 model.

5302

Indicates a feature or message that is only available on the TOS5302 model.

★ Memo

Indicates a feature or message that is only available on the TOS5302 model.

Contents

About the Operation Manuals	1
Notations Used in This Manual	1

Remote Control

Remote Control Overview	6
Using the USB Interface	6
Installing the VISA library	7

2 Message Overview

Message Overview	10
SCPI command syntax	10
Parameters	12

3 Command Reference

Command Description in This Manual	16
IEEE 488.2 Common Commands	17
Test Mode Settings	20
AC Withstanding Voltage Test (ACW) Conditions	21
Measurement methods setting (ACW)	21
Test voltage setting (ACW)	21
Limit voltage setting (ACW)	21
Upper limit setting (ACW)	22
Lower limit setting (ACW)	22
Test time setting (ACW)	23
Start voltage setting (ACW)	23
Voltage rise time setting (ACW)	24
Voltage fall time setting (ACW)	24
Test voltage frequency setting	24
DC Withstanding Voltage Test (DCW) Conditions	25
Test voltage setting (DCW)	25
Limit voltage setting (DCW)	25
Upper limit setting (DCW)	26
Lower limit setting (DCW)	26
Test time setting (DCW)	27
Start voltage setting (DCW)	27
Voltage rise time setting (DCW)	28
Judgment wait time settings (DCW)	28
Insulation Resistance Test (IR) Conditions	29
Test voltage setting (IR)	29
Limit voltage setting (IR)	29
Upper limit setting (IR)	30
Lower limit setting (IR)	31
Test time setting (IR)	31
Judgment wait time settings (IR)	32
About Sequences	33
Test Execution (SEQUENCE2:TEST)	35
Querying Measured Values (SEQUENCE1:ACQUIRE)	37
Various Settings	42
Date and time settings	42
PASS judgment result hold time setting	43
Buzzer volume settings	43

Calibration period setting	44
Other settings	44
Status Register and Status Report Function	46
IEEE 488.2 Register Model	48
Status byte register	48
Event status register (standard event status register).....	49
SCPI Register Model.....	50
OPERation status register (STATus:OPERation)	50
PROTeCting status register (STATus:OPERation:PROTeCting)	52
TESTing status register (STATus:OPERation:TESTing).....	54
QUEStionable status register (STATus:QUEStionable)	56
Preset status	57
Tutorial	58
Performing tests.....	58

Appendix

A List of Messages	60
B List of Errors	66
C Default State	69
D Command processing time	71
E Using Visual Basic 2008	72

INDEX.....	75
-------------------	-----------





1

Remote Control

This chapter provides a general explanation of the remote control function.

Remote Control Overview

In addition to using the front panel, the product can be controlled remotely through the USB interface.

The remote interface complies with IEEE Std 488.2-1992 and SCPI Specification 1999.0.

■ Measuring instrument interface standards

The TOS5300 Series complies with the following standards.

- IEEE Std 488.2-1992 IEEE Standard Codes, Formats, Protocols, and Common Commands For Use With IEEE Std 488.1-1987
- IEEE Std 488.1-1987 IEEE Standard Digital Interface for Programmable Instrumentation
- IEEE Std 1174-2000 IEEE Standard Serial Interface for Programmable Instrumentation
- Standard Commands for Programmable Instruments (SCPI) version 1999.0
- Universal Serial Bus Specification Rev 2.0
- Universal Serial Bus Test and Measurement Class Specification (USBTMC) Rev 1.0
- Universal Serial Bus Test and Measurement Class, Subclass USB488 Specification (USBTMC-USB488) Rev 1.0

Using the USB Interface

When the product is being controlled remotely, the USB icon (**USB**) appears on the front-panel screen. To use the front panel to switch the product back to local mode, press LOCAL.

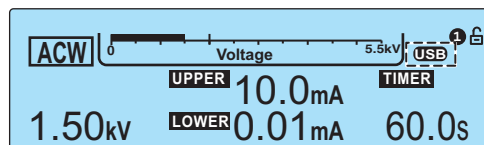

To use the USB interface to control the TOS5300 Series, a driver that supports the USB Test & Measurement class (USBTMC) must be installed on the controller.

The USBTMC driver is installed automatically by the VISA library.

NOTE

Noise may be generated by problems such as the outputs being shorted or the DUT insulation being damaged. This noise may cause errors in the remote control communication. To reduce the effect of noise, keep the USB cable at least 30 cm away from the test leads and the DUT.

USB feature

- Complies with USB specification 2.0
- Complies with USBTMC specification 1.0 and USBTMC-USB488 specification 1.0
- Baud rate: 12 Mbps maximum (full speed)
- VID (vendor ID): 0x0B3E
- PID (product ID): 0x1017

Service request

The TOS5300 Series is equipped with service request and serial polling functions.

Installing the VISA library

VISA (Virtual Instrument Software Architecture) is a specification for standard software that is used to connect instruments. VISA was defined by the IVI Foundation.

A VISA library is required to use the software application. The VISA library (NI-VISA, Keysight VISA, or KI-VISA) must be installed on the controller (Windows).

One of the VISA libraries (driver software implemented in compliance with the VISA specifications) below is necessary.

- NI-VISA by National Instruments (Ver. 5.1.1 or later)
- Keysight VISA by Keysight Technologies (Keysight IO Libraries Suite 16.0 or later)
- KI-VISA Ver. 5.0.4 or later

NOTE

- Do not install multiple VISA libraries on the same PC. Doing so may cause errors.
- If NI-VISA or Keysight VISA is already installed on your PC, you do not need to install KI-VISA.

KI-VISA is an original VISA library developed by Kikusui Electronics Corporation that supports the IVI VISA specifications 5.0. You can download the most recent version of this library from the Kikusui Electronics Corporation website (<https://www.kikusui.co.jp/en/download/>).



This page is intentionally blank.





2

Message Overview

This chapter gives an overview of remote control messages. It then explains topics such as the make-up of the SCPI commands that are used for remote control and the command syntax.

Message Overview

The information that is transferred between the controller (the PC) and the TOS5300 Series is referred to as "messages."

The TOS5300 Series uses the SCPI language for these messages.

The messages that the PC sends to the TOS5300 Series are commands. The messages that the TOS5300 Series sends to the PC are responses.

Commands are used to execute functions or change settings on the TOS5300 Series or to query its settings or status. Responses are used to return the product's settings or status.

SCPI command syntax

Command hierarchy

SCPI is an ASCII-based command language that was designed for test and measuring equipment. The command structure is composed of the common roots and nodes that are the building blocks of the SCPI subsystem. A command consists of a program header, parameters, and punctuation marks.

The following table uses the SYSTem subsystem as an example to explain the hierarchy.

Program header	Parameter	Node level
:SYSTem		Root node
:CONFigure		2nd level
:BEEPer		2nd level
:VOLume		3rd level
:FAIL	<numeric>	4th level
:PASS	<numeric>	4th level
:DATE	<nr1>, <nr1>, <nr1>	2nd level
:ERRor		2nd level
[:NEXT]	<code>, "<description>"	3rd level

- A colon (:) separates a higher node from a lower node.

Command syntax

In this manual, SCPI commands are expressed in the following format.

Example:

```
SYSTem:CONFigure:BEEPer:VOLume:PASS {<numeric>|MINimum|MAXimum}
```

- SCPI commands can be written in long form (with all the characters) or in short form (omitting the lowercase characters).
SCPI commands can be transmitted in either long form or short form.
- SCPI commands are not case sensitive. VOLT, Volt, and volt are all received as the short form of the VOLTage command.
VOLUME, Volume, and volume are all received as the long form of the VOLume command.
- A space separates a program header and its parameters.
- Multiple parameters are separated by commas.
- Compound commands can be created by concatenating two commands with a semicolon.

Example:

SYSTem:CONFiGure:BEEPer:VOLume:FAIL MINimum;PASS MINimum

This compound command sends the same commands as the two following commands.

SYSTem:CONFiGure:BEEPer:VOLume:FAIL MINimum

SYSTem:CONFiGure:BEEPer:VOLume:PASS MINimum

In the first command (SYSTem:CONFiGure:BEEPer:VOLume:FAIL), SYSTem:CONFiGure:BEEPer:VOLume is set as the path. Therefore, in the second command, SYSTem:CONFiGure:BEEPer:VOLume can be omitted.

If you specify a node that is not defined in the current path (except for FAIL and PASS), an error will occur.

- Program headers are separated by colons.
- By using colons and semicolons, you can concatenate commands of different subsystems.

Example:

SENSe:JUDGment MINimum;:SOURce:VOLTagE?

There are two root nodes in this compound command: SENSe and SOURce.

When the second command or later begins with a colon, the path that was specified by the previous command is cleared.

- The maximum length of a command that you can transmit on a single line is 128 bytes.

Special symbols and characters

The special symbols and characters that are used in this manual for the SCPI command syntax are explained below.

Symbol or character	Description
< >	Character strings inside the < and > symbols indicate program data. Do not include the < and > symbols in the actual program.
{ }	Characters and numbers delimited by " " inside the { and } symbols indicate that one of the delimited items is to be selected. Do not include the { and } symbols in the actual program.
[]	Character strings inside [and] indicate optional data. When optional data is not sent with the program, the default value is sent. Do not include the [and] symbols in the actual program.

Queries

You can query the settings and status of the TOS5300 Series.

To make a query, append a question mark to the end of the program header section. If the query has parameters, insert a space after the question mark, and then write the parameters.

Example:

VOLTagE? MINimum

NOTE

If you want to send two queries on separate lines, send the second query after you have received the response to the first one. If you send query commands on two lines at the same time, you may receive an incomplete response.

Terminating character strings

All commands must be terminated with a valid terminator.

The available terminators are <line feed> (ASCII 0x0A) and EOI (end-or-identify).

You can use either of these terminators to terminate a command.

When you terminate a command string, the path is reset to the root level.

NOTE CR (ASCII 0x0D) is not a terminator.

Common commands

See p. 17

There are commands that are common to the IEEE-488.2 and SCPI standards for functions such as resetting devices and performing self-diagnoses. These common commands start with an asterisk (*). These commands may have one or multiple parameters.

Parameters

The SCPI parameter format is derived from the program parameter format that is defined in IEEE 488.2.

The program data expression format that the TOS5300 Series uses is shown below.

Non-numeric parameters

The TOS5300 Series uses the following three parameter types.

Symbol or character	Description
String data (String)	Used when a series of ASCII characters are requested. Be sure to enclose strings in single or double quotation marks. The opening and closing quotation marks must match (you cannot mix single and double quotation marks). Example: <code>PROG:NAME "ACW2IR"</code> If you want to include a quotation mark as part of the string, enter consecutive quotation marks (with no characters between them). ASCII codes 20H to 7EH can be used in strings.
Character data (Character)	Used when only a limited number of values are available for a program setting. Responses are returned in short form. Example: <code>TRIGger:SOURce {IMMediate BUS TIMer TEST}</code>
Boolean data (Boolean)	Used to express a condition of 1 or 0, or ON or OFF. Responses are returned as 1 or 0. Example: <code>SOURce:VOLTagE:TIMer:STATe {ON OFF 1 0}</code>

Numeric parameters

The TOS5300 Series uses the following five parameter types.

Symbol or character	Description
NR1	Represents an integer value. ¹
NR2	Represents a real number in floating-point format. ¹
NR3	Represents a real number in scientific notation. ¹ If 380 is returned in the response data, it is returned as +3.80000+E02. Five decimal places are used.
NRF	NRF is a generic term that includes NR1, NR2, and NR3.
Numeric	Represents values such as the decimal point, optional prefixes, and measurement units. Numbers are expressed the same as NRF. MINimum and MAXimum are available as substitutes for declaring certain values. You can also use units such as V, A, and S in numeric parameters. If a value that cannot be assigned is entered, the TOS5300 Series rounds the value to the closest possible value. Example: <code>SYSTem:CONFIgure:BEEPer:VOLume:PASS 2.0</code> <code>SYST:CONF:BEEP:VOL:PASS</code> must be set to a value from 0.0 to 1.0, so even if you attempt to set the value to 2.0, it will be set to 1.0.

¹ Details are given in the "IEEE 488.2 Standard Digital Interface for Programmable Instrumentation."

Special form numeric parameters

The special form numeric parameters MINimum and MAXimum can be used as substitutes for the actual maximum and minimum values when the parameter is numeric.

The following example sets the volume level of the buzzer that is sounded when a PASS judgment occurs to the minimum value.

SYSTem:CONFIgure:BEEPer:VOLume:PASS MINimum

You can query the minimum and maximum values for most parameters.

SOURce:VOLTage:PROTection? MAXimum

Measurement units

The default measurement units are listed below. Commands are accepted even if measurement units are not specified.

- A (current)
- OHM (resistance)
- HZ (frequency)
- V (voltage)
- S (seconds)

The following optional prefixes are supported. If you use optional prefixes, specify the measurement unit.

- G (giga)
- K (kilo)
- U (micro)
- MA (mega)
- M (milli)

To enter "μ" in a parameter, use "U." When the measurement unit is "Hz" or "OHM" and you enter "M" in the parameter, the unit will be "mega."

NOTE

The unit symbols in the International System of Units contain lowercase characters. The IEEE standard uses uppercase characters. SCPI commands are not case sensitive.



This page is intentionally blank.





3

Command Reference

This chapter explains topics such as command details and registers.

Command Description in This Manual

In this manual, commands are described in the following manner.

Append the value that you want to set the setting to after the command.
To set the test voltage of a DC withstanding voltage test (DCW) to 6.2 kV, send SOUR:DCW:VOLT 6.2k.

SOUR:DCW:VOLT

Sets the test voltage.

Commands that have these marks are affected when an *RST or *RCL command is sent. The settings for the command are changed to the values that are shown in the "Default values" section. The test voltage is changed to 0 volts when the *RST command is sent.

*RST *RCL

The commands are listed in the long form. The lowercase characters can be omitted. Sections that are enclosed in braces ([]) can also be omitted.

The parameters are listed. In this command, the parameter is numeric. In addition to specifying the desired value, you can specify the minimum or maximum value.

Command SOURce:DCW:VOLTage[LEVel] {<numeric> | MIN | MAX}
SOURce:DCW:VOLTage[LEVel]? {MIN | MAX}

The setting range is listed. Optional symbols such as m and μ can also be used.

Parameter Value: 0 to 6.2k (The default value is 0.)

The unit for the value being set. The unit can be omitted.

Unit: V

Specify MAX to set the maximum value.

Specify MIN to set the minimum value.

Response Returns the test voltage in <NR3> format.

The format of the value that is returned when a query is sent.

References to command descriptions

Item	See
Command syntax	p. 10
Parameters	p. 12
Units	p. 13
Queries	p. 11
Expression format	p. 12
List of messages	p. 60
List of errors	p. 66
Command processing time	p. 71

IEEE 488.2 Common Commands

*CLS

 p. 46
IEEE 488.2-1992, section
10.3

Clears all event registers including the status byte, event status, and error/event queue.

Command *CLS

*ESE

 p. 49
IEEE 488.2-1992, section
10.10

Sets the event status enable register that is counted by the event summary bit (ESB) of the status byte.

Command *ESE <NR1>
*ESE?

Parameter Value: 0 to 255
An SCPI error (-222, "Data out of range") occurs if the specified value is outside the range.

Example When *ESE 16 is transmitted, bit 4 of the event status enable register is set. Each time the execution error bit (bit 4) of the event status register is set, the summary bit (ESB) of the status byte is set.

Response Returns the value of the event status enable register in <NR1> format.

*ESR

 p. 49
IEEE 488.2-1992, section
10.12

Queries the event status register. Registers that are read are cleared.

Command *ESR?

Response Returns the value of the event status register in <NR1> format and clears the register.

*IDN

 p. 49
IEEE 488.2-1992, section
10.14

Queries the model name, serial number, and firmware version of the TOS5300 Series.

Command *IDN?

Response The response to *IDN? is indicated below.

Example For a TOS5301 with serial number AB123456 and firmware version 1.00, *IDN? returns:
KIKUSUI, TOS5301, AB123456, 1.00

***OPC**

 See
IEEE 488.2-1992, section
10.18

Sets the OPC bit (bit 0) of the event status register when all the commands that are in standby have been processed.

Command *OPC
*OPC?

Response Returns "1" when all the commands that are in standby have been processed.

***OPT**

Queries the options that are installed in the TOS5300 Series. This command performs the same function as the SYSTem:OPTion? command.

Command *OPT?

Response Returns "0" if no options are installed. Returns one of the following responses in <character> format if options are installed.
Returns "RC0X-TOS" if an RC01-TOS, RC02-TOS, HP01A-TOS, or HP02A-TOS option is installed.
Returns "SIGNAL I/O" if a SIGNAL I/O option is installed.

Example If the RC01-TOS is installed,
this command returns "RC0X-TOS."

***PSC**

 See
IEEE 488.2-1992, section
10.25

Sets whether the event status enable register and service request enable register are cleared when the POWER switch is turned on.

Command *PSC <NR1>
*PSC?

Parameter	Value:	0	When the POWER switch is turned on, the *ESE and *SRE settings are not cleared.
		1	When the POWER switch is turned on, the *ESE and *SRE settings are cleared.

An SCPI error (-222, "Data out of range") occurs if the specified value is outside the range.

Example To enable the power-on SRQ feature:
*PSC 0 ; *SRE 32 ; *ESE 128

Response Returns the power-on status setting in response to the PSC? query.

***RCL**

 See p. 69

Aborts the test execution (operation) and loads the settings that have been saved to memory. For the commands that are affected by *RCL, see "Default State".

Command *RCL <NR1>

Parameter	Value:	1 to 3	Memory number
-----------	--------	--------	---------------

An SCPI error (-222, "Data out of range") occurs if the specified value is outside the range.

***RST**

 p. 69
IEEE 488.2-1992, section
10.32

Aborts the test execution (operation) and resets the panel settings to their default values.
For the commands that are affected by *RST, see "Default State."

Command *RST

***SAV**

 p. 69

Saves the current settings to memory. The settings that are saved are the same as those that will be loaded with the *RCL command. For details, see "Default State."

Command *SAV <NR1>

Parameter Value: 1 to 3 Memory number
An SCPI error (-222, "Data out of range") occurs if the specified value is outside the range.

***SRE**

 p. 69
IEEE 488.2-1992, section
10.34

Sets the service request enable register.

The service request enable register can be used to select which summary messages in the status byte register will perform service requests.

To clear the service request enable register, send *SRE 0. If the register is cleared, service requests cannot be generated using status information.

Command *SRE <NR1>
*SRE?

Parameter Value: 0 to 255
An SCPI error (-222, "Data out of range") occurs if the specified value is outside the range.

Example Sending *SRE 8 sets bit 3 of the service request enable register. Each time the summary bit (bit 3) of the QUEStionable status register in the status byte is set, a service request message is generated.

Response Returns the value of the service request enable register in <NR1> format.

***STB**

 p. 48
IEEE 488.2-1992, section
10.36

Queries the contents of the status byte register and the MSS (master summary status) message.

The response is the same as serial polling only with the exception that the MSS message appears in place of the RQS message in bit 6.

Command *STB?

Response Returns the value of the status byte register and the MSS message (bit 6) in <NR1> format.

*TRG

 See
IEEE 488.2-1992, section
10.37

Trigger command.

This is a substitute command for the IEEE 488.1 get message (Group Execute Trigger). If the TOS5300 Series is in a state in which it does not accept triggers, an SCPI error (-211, "Trigger ignored") occurs.

Command *TRG

*TST

 See
IEEE 488.2-1992, section
10.38

Executes a self-test. You can query which error occurred by sending the SYST:ERR? command.

Command *TST?

Response Returns "0" if no errors are detected. Returns the error code if an error is detected.

*WAI

 See
IEEE 488.2-1992, section
10.39

Prevents the TOS5300 Series from executing subsequent commands until all operations that are in standby have been completed.

Command *WAI

Test Mode Settings

SOUR:FUNC:MODE

[*RST](#) [*RCL](#)

Sets the test mode. You can only set the test mode to one of the test modes that is available on your model.

Command SOURce:FUNCtion:MODE {ACW|DCW|IR}
SOURce:FUNCtion:MODE?

Parameter	Value:	ACW	AC withstanding voltage test (default)
		DCW	DC withstanding voltage test 5301
		IR	Insulation resistance test 5302

Response Returns the test mode in <character> format.

AC Withstanding Voltage Test (ACW) Conditions

These are commands for setting the AC withstanding voltage test conditions.

Measurement methods setting (ACW)

SENS:MODE

* RST

Sets the measurement method.

Command SENSE [:ACW]:MODE {RMS|AVE}
SENSE [:ACW]:MODE?

Parameter	Value:	RMS	True rms response (default)
		AVE	Mean-value response

Response Returns the measurement method in <character> format.

Test voltage setting (ACW)

SOUR:VOLT

* RST * RCL

Sets the test voltage.

Command SOURCE [:ACW]:VOLTage[:LEVel] {<numeric>|MIN|MAX}
SOURCE [:ACW]:VOLTage[:LEVel]? {MIN|MAX}

Parameter	Value:	0 to 5.5 k (The default value is 0.)
	Unit:	V

Response Returns the test voltage setting in <NR3> format.

Limit voltage setting (ACW)

SOUR:VOLT:PROT

* RST * RCL

Sets the limit voltage.

Command SOURCE [:ACW]:VOLTage:PROTection[:LEVel][:UPPer] {<numeric>|MIN|MAX}
SOURCE [:ACW]:VOLTage:PROTection[:LEVel][:UPPer]? {MIN|MAX}

Parameter	Value:	0 to 5.5 k (The default value is 5.5 k.)
	Unit:	V

Response Returns the limit voltage in <NR3> format.

Upper limit setting (ACW)

SENS:JUDG

* RST * RCL

Sets the upper limit that is used in judgments (UPPER).

Command `SENSe[:ACW]:JUDGment[:UPPer] {<numeric>|MIN|MAX}`
`SENSe[:ACW]:JUDGment[:UPPer]? {MIN|MAX}`

Parameter Value: 0.01 m to 110 m (The default value is 0.02 m.)
 Unit: A

Response Returns the upper limit in <NR3> format.

Lower limit setting (ACW)

SENS:JUDG:LOW

* RST * RCL

Sets the lower limit that is used in judgments (LOWER). This setting is enabled when SENS:JUDG:LOW:STAT is set to ON.

Command `SENSe[:ACW]:JUDGment:LOWer {<numeric>|MIN|MAX}`
`SENSe[:ACW]:JUDGment:LOWer? {MIN|MAX}`

Parameter Value: 0.01 m to 110 m (The default value is 0.01 m.)
 Unit: A

Response Returns the lower limit in <NR3> format.

SENS:JUDG:LOW:STAT

* RST * RCL

Sets whether the lower limit is used in judgments (LOWER ON/OFF). Use SENS:JUDG:LOW to set the lower limit.

Command `SENSe[:ACW]:JUDGment:LOWer:STATe {ON|OFF|1|0}`
`SENSe[:ACW]:JUDGment:LOWer:STATe?`

Parameter Value: ON (1) The limit is used in judgments.
 OFF (0) The limit is not used in judgments (default).

Response Returns whether the lower limit is used in judgments in <NR1> format.

Test time setting (ACW)

SOUR:VOLT:TIM

* RST * RCL

Sets the test time (TIMER). This setting is enabled when SOUR:VOLT:TIM:STAT is set to ON.

Command SOURce [:ACW] :VOLTage:TIMer {<numeric>|MIN|MAX}
SOURce [:ACW] :VOLTage:TIMer? {MIN|MAX}

Parameter Value: 0.1 to 999.0 (The default value is 0.1.)
Unit: S

Response Returns the test time in <NR3> format.

SOUR:VOLT:TIM:STAT

* RST * RCL

Sets whether to stop testing after the set test time elapses (TIMER ON/OFF). Use SOUR:VOLT:TIM to set the test time.

Command SOURce [:ACW] :VOLTage:TIMer:STATe {ON|OFF|1|0}
SOURce [:ACW] :VOLTage:TIMer:STATe?

Parameter Value: ON (1) Testing is stopped after the test time elapses (default).
OFF (0) Testing is not stopped after the test time elapses.

Response Returns whether testing is stopped after the test time elapses in <NR1> format.

Start voltage setting (ACW)

SOUR:VOLT:STAR:STAT

* RST * RCL

Sets whether the start voltage is used. The start voltage is 50 % of the test voltage.

Command SOURce [:ACW] :VOLTage:STARt:STATe {ON|OFF|1|0}
SOURce [:ACW] :VOLTage:STARt:STATe?

Parameter Value: ON (1) The start voltage is used.
OFF (0) The start voltage is not used.

Response Returns whether the start voltage is used in <NR1> format.

Voltage rise time setting (ACW)

SOUR:VOLT:SWE:TIM

* RST * RCL

Sets the voltage rise time (Rise Time).

Command `SOURce [:ACW]:VOLTage:SWEep[:RISE]:TIMer {<numeric>|MIN|MAX}`
`SOURce [:ACW]:VOLTage:SWEep[:RISE]:TIMer? {MIN|MAX}`

Parameter Value: 0.1 to 10.0 (The default value is 0.1.)
 Unit: S

Response Returns the voltage rise time (Rise Time) in <NR3> format.

Voltage fall time setting (ACW)

SOUR:VOLT:SWE:FALL:TIM:STAT

* RST * RCL

Sets whether the voltage fall time (Fall Time) is used.

Command `SOURce [:ACW]:VOLTage:SWEep:FALL:TIMer:STATe {ON|OFF|1|0}`
`SOURce [:ACW]:VOLTage:SWEep:FALL:TIMer:STATe?`

Parameter Value: ON (1) The voltage fall time (Fall Time) is used.
 OFF (0) The voltage fall time (Fall Time) is not used (default).

Response Returns whether the voltage fall time (Fall Time) is used in <NR1> format.

Test voltage frequency setting

SOUR:VOLT:FREQ

* RST * RCL

Sets the test voltage frequency.

Command `SOURce [:ACW]:VOLTage:FREQuency {<numeric>|MIN|MAX}`
`SOURce [:ACW]:VOLTage:FREQuency? {MIN|MAX}`

Parameter Value: 50, 60 (The default value is 50.)
 Unit: HZ

Response Returns the test voltage frequency in <NR3> format.

DC Withstanding Voltage Test (DCW) Conditions 5301

These are commands for setting the DC withstanding voltage test conditions.

Test voltage setting (DCW)

SOUR:DCW:VOLT

* RST * RCL

Sets the test voltage.

Command `SOURce:DCW:VOLTage[:LEVel] {<numeric>|MIN|MAX}`
`SOURce:DCW:VOLTage[:LEVel]? {MIN|MAX}`

Parameter Value: 0 to 6.2 k (The default value is 0.)
Unit: V

Response Returns the test voltage setting in <NR3> format.

Limit voltage setting (DCW)

SOUR:DCW:VOLT:PROT

* RST * RCL

Sets the limit voltage.

Command `SOURce:DCW:VOLTage:PROTection[:LEVel] [:UPPer]`
`{<numeric>|MIN|MAX}`
`SOURce:DCW:VOLTage:PROTection[:LEVel] [:UPPer]? {MIN|MAX}`

Parameter Value: 0 to 6.2 k (The default value is 6.2 k.)
Unit: V

Response Returns the limit voltage in <NR3> format.

Upper limit setting (DCW)

SENS:DCW:JUDG

* RST * RCL

Sets the upper limit that is used in judgments (UPPER).

Command `SENSe:DCW:JUDGment[:UPPer] {<numeric>|MIN|MAX}`
`SENSe:DCW:JUDGment[:UPPer]? {MIN|MAX}`

Parameter Value: 0.01 m to 11 m (The default value is 0.02 m.)
 Unit: A

Response Returns the upper limit in <NR3> format.

Lower limit setting (DCW)

SENS:DCW:JUDG:LOW

* RST * RCL

Sets the lower limit that is used in judgments (LOWER).
 This setting is enabled when SENS:DCW:JUDG:LOW:STAT is set to ON.

Command `SENSe:DCW:JUDGment:LOWer {<numeric>|MIN|MAX}`
`SENSe:DCW:JUDGment:LOWer? {MIN|MAX}`

Parameter Value: 0.01 m to 11 m (The default value is 0.01 m.)
 Unit: A

Response Returns the lower limit in <NR3> format.

SENS:DCW:JUDG:LOW:STAT

* RST * RCL

Sets whether the lower limit is used in judgments (LOWER ON/OFF). Use SENS:DCW:JUDG:LOW to set the lower limit.

Command `SENSe:DCW:JUDGment:LOWer:STATe {ON|OFF|1|0}`
`SENSe:DCW:JUDGment:LOWer:STATe?`

Parameter Value: ON (1) The limit is used in judgments.
 OFF (0) The limit is not used in judgments (default).

Response Returns whether the lower limit is used in judgments in <NR1> format.

Test time setting (DCW)

SOUR:DCW:VOLT:TIM

* RST * RCL

Sets the test time (TIMER).
This setting is enabled when SOUR:DCW:VOLT:TIM:STAT is set to ON.

Command SOURce:DCW:VOLTage:TIMer {<numeric>|MIN|MAX}
SOURce:DCW:VOLTage:TIMer? {MIN|MAX}

Parameter Value: 0.1 to 999.0 (The default value is 0.1.)
Unit: S

Response Returns the test time in <NR3> format.

SOUR:DCW:VOLT:TIM:STAT

* RST * RCL

Sets whether to stop testing after the set test time elapses (TIMER ON/OFF). Use SOUR:DCW:VOLT:TIM to set the test time.

Command SOURce:DCW:VOLTage:TIMer:STATe {ON|OFF|1|0}
SOURce:DCW:VOLTage:TIMer:STATe?

Parameter Value: ON (1) Testing is stopped after the test time elapses (default).
OFF (0) Testing is not stopped after the test time elapses.

Response Returns whether testing is stopped after the test time elapses in <NR1> format.

Start voltage setting (DCW)

SOUR:DCW:VOLT:STAR:STAT

* RST * RCL

Sets whether the start voltage is used. The start voltage is 50 % of the test voltage.

Command SOURce:DCW:VOLTage:STARt:STATe {ON|OFF|1|0}
SOURce:DCW:VOLTage:STARt:STATe?

Parameter Value: ON (1) Testing starts at the start voltage.
OFF (0) Testing does not start at the start voltage (default).

Response Returns whether the start voltage is used in <NR1> format.

Voltage rise time setting (DCW)

SOUR:DCW:VOLT:SWE:TIM

* RST * RCL

Sets the voltage rise time (Rise Time).

Command SOURce:DCW:VOLTage:SWEep[:RISE]:TIMer {<numeric>|MIN|MAX}
SOURce:DCW:VOLTage:SWEep[:RISE]:TIMer? {MIN|MAX}

Parameter Value: 0.1 to 10.0 (The default value is 0.1.)
Unit: S

Response Returns the voltage rise time (Rise Time) in <NR3> format.

Judgment wait time settings (DCW)

SENS:DCW:JUDG:DEL

* RST * RCL

Sets the time to wait after testing starts before starting judgment (WAIT).

Command SENSE:DCW:JUDGment:DELay {<numeric>|MIN|MAX}
SENSE:DCW:JUDGment::DELay? {MIN|MAX}

Parameter Value: 0.1 to 10.0 (The default value is 0.1.)
Unit: S

Response Returns the judgment wait time in <NR3> format.

Insulation Resistance Test (IR) Conditions 5302

These are commands for setting the insulation resistance test conditions.

Test voltage setting (IR)

SOUR:IR:VOLT

* RST * RCL

Sets the test voltage.

Command `SOURce:IR:VOLTage[:LEVel] {<numeric>|MIN|MAX}`
`SOURce:IR:VOLTage[:LEVel]? {MIN|MAX}`

Parameter Value: 25, 50, 100, 125, 250, 500, 1000 (The default is 25.)

Unit: V

If you specify a voltage that cannot be used, the voltage is set to the next lowest value that can be used.

Example If you specify 999 V, the voltage is set to 500 V.

Response Returns the test voltage setting in <NR3> format.

Limit voltage setting (IR)

SOUR:IR:VOLT:PROT

* RST * RCL

Sets the limit voltage.

Command `SOURce:IR:VOLTage:PROTection[:LEVel][:UPPer]`
`{<numeric>|MIN|MAX}`
`SOURce:IR:VOLTage:PROTection[:LEVel][:UPPer]? {MIN|MAX}`

Parameter Value: 25, 50, 100, 125, 250, 500, 1000 (The default is 1000.)

Unit: V

Response Returns the limit voltage in <NR3> format.

Upper limit setting (IR)

SENS:IR:JUDG

* RST * RCL

Sets the upper limit that is used in judgments (UPPER). This setting is enabled when SENS:IR:JUDG:STAT is set to ON.

Command `SENSe:IR:JUDGment[:UPPer] {<numeric>|MIN|MAX}`
`SENSe:IR:JUDGment[:UPPer] {MIN|MAX}`

Parameter Value: 30 k to 5 G (The default is 100 M.)
 Unit: OHM

Response Returns the upper limit in <NR3> format.

SENS:IR:JUDG:STAT

* RST * RCL

Sets whether the upper limit is used in judgments (UPPER ON/OFF). Use SENS:IR:JUDG to set the upper limit.

Command `SENSe:IR:JUDGment[:UPPer]:STATe {ON|OFF|1|0}`
`SENSe:IR:JUDGment[:UPPer]:STATe?`

Parameter Value: ON (1) The limit is used in judgments.
 OFF (0) The limit is not used in judgments (default).

Response Returns whether the upper limit is used in judgments in <NR1> format.

SENS:IR:MODE

* RST * RCL

Sets the current detection response speed during upper limit judgment.

Command `SENSe:IR:MODE {FASt|MID|SLOw}`
`SENSe:IR:MODE?`

Parameter Value: FASt mode
 MID mode (default)
 SLOw mode

Response Returns the current detection response speed during upper limit judgment in <character> format.

Lower limit setting (IR)

SENS:IR:JUDG:LOW

* RST * RCL

Sets the lower limit that is used in judgments (LOWER). This setting is enabled when SENS:IR:JUDG:LOW:STAT is set to ON.

Command `SENSe:IR:JUDGment:LOWer {<numeric>|MIN|MAX}`
`SENSe:IR:JUDGment:LOWer? {MIN|MAX}`

Parameter Value: 30 k to 5 G (The default is 1.00 M.)
 Unit: OHM

Response Returns the lower limit in <NR3> format.

SENS:IR:JUDG:LOW:STAT

* RST * RCL

Sets whether the lower limit is used in judgments (LOWER ON/OFF). Use SENS:IR:JUDG:LOW to set the lower limit. When SENS:IR:JUDG:STAT is set to OFF, you can set SENS:IR:JUDG:LOW:STAT to OFF (this setting is enabled).

Command `SENSe:IR:JUDGment:LOWer:STATe {ON|OFF|1|0}`
`SENSe:IR:JUDGment:LOWer:STATe?`

Parameter Value: ON (1) The limit is used in judgments (default).
 OFF (0) The limit is not used in judgments.

Response Returns whether the lower limit is used in judgments in <NR1> format.

Test time setting (IR)

SOUR:IR:VOLT:TIM

* RST * RCL

Sets the test time (TIMER). This setting is enabled when SOUR:IR:VOLT:TIM:STAT is set to ON.

Command `SOURce:IR:VOLTage:TIMer {<numeric>|MIN|MAX}`
`SOURce:IR:VOLTage:TIMer? {MIN|MAX}`

Parameter Value: 0.1 to 999.0 (The default value is 0.1.)
 Unit: S

Response Returns the test time in <NR3> format.

SOUR:IR:VOLT:TIM:STAT

* RST * RCL

Sets whether to stop testing after the set test time elapses (TIMER ON/OFF).

Command `SOURce:IR:VOLTage:TIMer:STATe {ON|OFF|1|0}`
`SOURce:IR:VOLTage:TIMer:STATe?`

Parameter	Value:	ON (1)	Testing is stopped after the test time elapses (default).
		OFF (0)	Testing is not stopped after the test time elapses.

Response Returns whether testing is stopped after the test time elapses in <NR1> format.

Judgment wait time settings (IR)

SENS:IR:JUDG:DEL

* RST * RCL

Sets the time to wait after testing starts before starting judgment (WAIT).

Command `SENSe:IR:JUDGment:DELAy {<numeric>|MIN|MAX}`
`SENSe:IR:JUDGment:DELAy? {MIN|MAX}`

Parameter	Value:	0.1 to 10.0 (The default value is 0.1.)	
	Unit:	S	

Response Returns the judgment wait time in <NR3> format.

About Sequences

Sequences are used to perform withstanding voltage tests, insulation resistance tests and measurements. The front-panel STOP switch remains enabled during remote control.

A sequence has three states: IDLE, INITiated, and WTG.

IDLE state

When the TOS5300 Series is on, all sequences are in the IDLE state. In this state, the trigger subsystem ignores all triggers. If you send the ABOR, *RST, or *RCL command, the trigger subsystem is switched to the IDLE state, regardless of its current state.

If you send the TRG command while the TOS5300 Series is in the IDLE state, tests will not be performed.

INITiated state

When you send the INIT command while the TOS5300 Series is in the IDLE state, the trigger function begins operating, and the tester switches to the INITiated state.

If the trigger source is set to IMMEDIATE, testing or measurements begin immediately.

If the trigger source is set to BUS or EXTERNAL, the TOS5300 Series switches to the WTG (Waiting for Trigger) state.

If the SEQUENCE1 (ACQUIRE) trigger source is set to TIMER, measurements begin after the trigger timer's set time elapses.

If the SEQUENCE1 (ACQUIRE) trigger source is set to TEST, measurements begin when the test begins.

WTG (Waiting for Trigger) state

If you send a trigger while the TOS5300 Series is in the WTG state, testing or measurements begin.

If the trigger source is set to BUS, send a software trigger.

If the SEQUENCE2 (TEST) trigger source is set to EXTERNAL, use the START switch to begin testing.

SEquence2 (TEST) trigger function flowchart flowchart

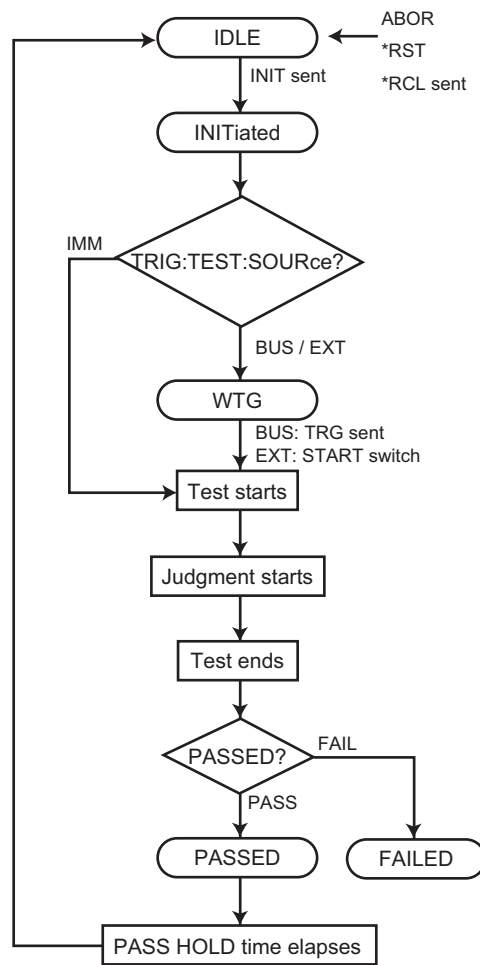

The TOS5300 Series has the following two trigger functions.

- SEquence1 (ACQuire)
Starts measurements and queries measured values.
- SEquence2 (TEST)
Executes test. You have to specify the execution conditions in advance.

Test Execution (SEquence2:TEST)

This function executes test. You have to specify the execution conditions in advance.

TRIG:SEQ2:SOUR / TRIG:TEST:SOUR

* RST

Sets the trigger source to apply to the SEquence2 (TEST) group.

Command TRIGger:SEquence2:SOURce {IMMediate|BUS|EXTernal}
TRIGger:SEquence2:SOURce?
TRIGger:TEST:SOURce {IMMediate|BUS|EXTernal}
TRIGger:TEST:SOURce?

Parameter	Value:	IMMediate	Begin testing immediately (default).
		BUS	Wait for a software trigger—a *TRG, TRIG, or IEEE 488.1 get (Group Execute Trigger) command—and then begin testing.
		EXTernal	Begin testing when the START switch is pressed.

Response Returns the trigger source in <character> format.

INIT:SEQ2 / INIT:NAME TEST / TEST:EXEC

Starts the test in the test mode that was set with SOUR:FUNC:MODE (starts the trigger function). Use the trigger source that was set with TRIG:SEQ2:SOUR or TRIG:TEST:SOUR to start the test.

Command INITiate[:IMMediate]:SEquence2
INITiate[:IMMediate]:NAME TEST
TEST:EXECute

TRIG:SEQ2 / TRIG:TEST

Executes a software trigger for the SEquence2 (TEST) group. This command is valid when TRIG:SEQ2:SOUR or TRIG:TEST:SOUR is set to BUS.

Command TRIGger:SEquence2[:IMMediate]
TRIGger:TEST[:IMMediate]

TEST:ABOR

Aborts the SEquence2 (TEST) group's test. The measured data is discarded.

Command TEST:ABORt

ABOR

Aborts the tests and measurements of all sequence groups. The trigger state of the TOS5300 Series immediately after it turns on is the same as its trigger state after it receives an ABOR command.

If you send an ABOR command while the TOS5300 Series is executing tests or measurements, the measured data is discarded.

If you send an ABOR command without first sending an INIT command and if the measurement data that is held in the TOS5300 Series is valid, the measured data is not discarded.

Command `ABORt`

TEST:PROT:CLE

Clears the protection mode.

Command `TEST:PROTection:CLEAr`

Querying Measured Values (SEquence1:ACQuire)

There are SCALAr and ARRAy nodes among the second nodes of the MEASure, READ, and FETCh queries. ARRAy is a default node that can be omitted.

You can query the measured value while tests (SEQ2) are being performed.

Trigger count	Node	Response
1	[:ARRay]	Single measured value
2 or more	[:ARRay]	Comma-separated list of all measured data points

TRIG:COUN

* RST

Sets the trigger count to apply to the SEquence1 (ACQuire) group.

Command TRIGger[:SEquence[1]]:COUNT {<numeric>|MIN|MAX}
TRIGger[:SEquence[1]]:COUNT?
TRIGger[:ACQuire]:COUNT {<numeric>|MIN|MAX}
TRIGger[:ACQuire]:COUNT?

Parameter Value: 1 to 100 (The default value is 1.)

Response Returns the trigger count in <NR3> format.

ABOR

Aborts the tests and measurements of all sequence groups. The trigger state of the TOS5300 Series immediately after it turns on is the same as its trigger state after it receives an ABOR command.

If you send an ABOR command while the TOS5300 Series is executing tests or measurements, the measured data is discarded.

If you send an ABOR command without first sending an INIT command and if the measurement data that is held in the TOS5300 Series is valid, the measured data is not discarded.

Command ABORt

MEAS:CURR / READ:CURR

Starts a new measurement and queries the current.

Command MEASure[:ARRay]:CURRent?
READ[:ARRay]:CURRent?

Response Returns the measured current in <NR3> format or the measured currents as a comma-separated list in <NR3>,<NR3>,... format.

Unit: A

MEAS:VOLT / READ:VOLT

Starts a new measurement and queries the voltage.

Command MEASure [:ARRay] :VOLTage?
READ [:ARRay] :VOLTage?

Response Returns the measured voltage in <NR3> format or the measured voltages as a comma-separated list in <NR3>,<NR3>,... format.

Unit: V

MEAS:RES / READ:RES

Starts a new measurement and queries the resistance.

Command MEASure [:ARRay] :RESistance?
READ [:ARRay] :RESistance?

Response Returns the measured resistance in <NR3> format or the measured resistances as a comma-separated list in <NR3>,<NR3>,... format.

Unit: OHM

MEAS:TIME / READ:TIME

Starts a new measurement and queries the elapsed test time.

Command MEASure [:ARRay] :TIME?
READ [:ARRay] :TIME?

Response Returns the measured elapsed test time in <NR3> format or the measured elapsed as a comma-separated list in <NR3>,<NR3>,... format.

Unit: s

TRIG:SOUR

* RST

Sets the trigger source to apply to the SEquence1 (ACQuire) group.

Command TRIGger [:SEquence[1]] :SOURce {IMMediate|BUS|TIMer|TEST}
TRIGger [:SEquence[1]] :SOURce?
TRIGger [:ACQuire] :SOURce {IMMediate|BUS|TIMer|TEST}
TRIGger [:ACQuire] :SOURce?

Parameter	Value:	IMMediate	Begin measuring immediately. (default).
		BUS	Wait for a software trigger (a *TRG, TRIG, or IEEE 488.1 get—Group Execute Trigger—command), and then begin measuring.
		TIMer	Begin measuring when the time set with TRIG:TIM elapses.
		TEST	Begin measuring when a test begins.

Response Returns the trigger source in <character> format.

TRIG:TIM

* RCL

Sets the trigger timer to apply to the SEquence1 (ACquire) group. This command is enabled when the trigger source is set to TIM.

Command TRIGger[:SEquence[1]]:TIMer {<numeric>|MIN|MAX}
 TRIGger[:SEquence[1]]:TIMer? {MIN|MAX}
 TRIGger[:ACquire]:TIMer {<numeric>|MIN|MAX}
 TRIGger[:ACquire]:TIMer? {MIN|MAX}

Parameter Value: 0 to 60.0 (The default value is 0.)
 Unit: S

Response Returns the trigger timer's set time in <NR3> format.

INIT:SEQ1 / INIT:NAME ACQ

Begins a new measurement (starts the trigger function).
 Measurement is started by the trigger source set with TRIG:SOUR.

Command INITiate[:IMMediate]:SEquence1
 INITiate[:IMMediate]:NAME ACquire

TRIG

Executes a software trigger for the SEquence1 (ACquire) group.

Command TRIGger[:SEquence[1]][:IMMediate]
 TRIGger[:ACquire][:IMMediate]

FETC:CURR

Queries the measured current without starting a new measurement.

Command FETCh[:ARRay]:CURRent?

Response Returns the measured current in <NR3> format or the measured currents as a comma-separated list in <NR3>,<NR3>,... format.
 Unit: A

FETC:VOLT

Queries the measured voltage without starting a new measurement.

Command FETCh[:ARRay]:VOLTage?

Response Returns the measured voltage in <NR3> format or the measured voltages as a comma-separated list in <NR3>,<NR3>,... format.
 Unit: V

FETC:RES

Queries the measured resistance without starting a new measurement.

Command FETCh [:ARRay] :RESistance?

Response Returns the measured resistance in <NR3> format or the measured elapsed as a comma-separated list in <NR3>,<NR3>,... format.

Unit: OHM

FETC:TIME

Queries the measured elapsed test time without starting a new measurement.

Command FETCh [:ARRay] :TIME?

Response Returns the measured elapsed test time in <NR3> format or the measured elapsed as a comma-separated list in <NR3>,<NR3>,... format.

Unit: s

RES

Queries the results of the previous test.

Command `RESult[:IMMEDIATE]?`

Response Returns the following results of the previous test: test number, program number, test mode, test start time, voltage, current, resistance, test time, and judgment result. Each result is separated by a comma in the following format: <NR1>, <NR1>, <character>, <NR1>, <NR3>, <NR3>, <NR3>, <NR3>, <NR3>, <character>.

Response format <NR1>Test number

A counter that is incremented each time a test is executed. After 4294967295, the count returns to 0.

<NR1>Program number

For a single test, 1 is always returned. For an auto test, 1 is returned for the first test, and 2 is returned for the next test.

(Example) ACW and then IR

If you send a RES? query after the ACW test, 1 is returned. If you send the query after the IR test, 2 is returned.

<Character>Test mode {ACW|DCW|IR}

ACW: AC withstanding voltage test

DCW: DC withstanding voltage test

IR: Insulation resistance test

<NR1>Test start time yyyy, mm, dd, hh, mm, ss (year, month, day, hour, minute, second)

<NR3>Voltage

Measured voltage

<NR3>Current

Measured current

If the test result is fail, the judgment criterion is returned.

<NR3>Resistance

Measured resistance

If the test result is fail, the judgment criterion is returned.

<NR3>Test time

The test time is returned.

<Character>Judgment result {PASS|U-FAIL|L-FAIL|PROT|ABORT}

PASS: The test was successful.

U-FAIL: A value exceeding the upper limit was detected.

L-FAIL: A value less than the lower limit was detected.

PROT: A protection function was activated, and the test was stopped.

ABORT: Test was aborted.

Various Settings

Date and time settings

SYST:CONF:DATE

Sets the date.

Command `SYSTem:CONFigure:DATE <YEAR_NR1>,<MONTH_NR1>,<DAY_NR1>`
`SYSTem:CONFigure:DATE?`

Parameter <YEAR_NR1> The year
Value: 2000 to 2099

Parameter <MONTH_NR1> The month
Value: 1 to 12

Parameter <DAY_NR1> The day
Value: 1 to 31

Response Returns the date in <NR1>,<NR1>,<NR1> format (a comma-separated list in which the data is in the order of year, month, day).

SYST:CONF:TIME

Sets the time.

Command `SYSTem:CONFigure:TIME <HOUR_NR1>,<MIN_NR1>,<SEC_NR1>`
`SYSTem:CONFigure:TIME?`

Parameter <HOUR_NR1> The hour
Value: 0 to 23

Parameter <MIN_NR1> The minutes, <SEC_NR1> the seconds
Value: 0 to 59

Response Returns the time in <NR1>,<NR1>,<NR1> format (a comma-separated list in which the data is in the order of hour, minute, second).

PASS judgment result hold time setting

SYST:CONF:PHOL

Sets the length of time that a PASS judgment result will be maintained.

Command `SYSTem:CONFIgure:PHOLd {<numeric>|MIN|MAX|INFIinity}`

`SYSTem:CONFIgure:PHOLd? {MIN|MAX}`

Parameter Value: 50 m, 100 m, 200 m, 1, 2, 5 (The default value is 50 m.)

INFIinity The PASS judgment result is maintained indefinitely (HOLD).

Response Returns the length of time that a PASS judgment result will be maintained in <NR3> format.

Unit: S

Buzzer volume settings

SYST:CONF:BEEP:VOL:FAIL

* RST

Sets the volume level of the buzzer that is sounded when a FAIL judgment occurs.

Command `SYSTem:CONFIgure:BEEPer:VOLume:FAIL {<numeric>|MIN|MAX}`

`SYSTem:CONFIgure:BEEPer:VOLume:FAIL? {MIN|MAX}`

Parameter Value: 0.0 to 1.0 (The default value is 0.5.)

Response Returns the volume level of the buzzer that is sounded when a FAIL judgment occurs in <NR3> format.

SYST:CONF:BEEP:VOL:PASS

* RST

Sets the volume level of the buzzer that is sounded when a PASS judgment occurs.

Command `SYSTem:CONFIgure:BEEPer:VOLume:PASS {<numeric>|MIN|MAX}`

`SYSTem:CONFIgure:BEEPer:VOLume:PASS? {MIN|MAX}`

Parameter Value: 0.0 to 1.0 (The default value is 0.3.)

Response Returns the volume level of the buzzer that is sounded when a PASS judgment occurs in <NR3> format.

Calibration period setting

SYST:CONF:CAL:DUE:CONT

Set the number of months until the calibration period.

Command `SYSTem:CONFIgure:CALibration:DUE:CONTRol`
`{<numeric>|MIN|MAX|INFIinity}`

`SYSTem:CONFIgure:CALibration:DUE:CONTRol? {MIN|MAX}`

Parameter Value: 3 to 36 (The default value is 12)
 INFIinity Indefinitely.

Response Returns the number of months until the calibration period in <NR1> format.
 Unit: month

Other settings

SYST:ERR

Queries the oldest error or event from the error/event queue. The error/event queue can hold up to 255 errors.

The error/event queue is cleared if a *CLS command is sent.

Command `SYSTem:ERRor [:NEXT] ?`

Response Returns the oldest error or event from the error/event queue in the following format.

Example If the queue is empty,
 this command returns 0 "No error."

Example If a command has been received that cannot be executed in the current operating state of the TOS5300 Series,
 this command returns -221, "Settings conflict."

If there are multiple errors in the queue, the errors are returned from the oldest error first. Errors are cleared from the queue after they have been returned.

SYST:KLOC

Locks or releases panel operations (key lock). When keys are locked, only the START and STOP switches are enabled.

Command `SYSTem:KLOCK {ON|OFF|1|0}`
`SYSTem:KLOCK?`

Parameter Value: ON (1) Panel operations are locked.
 OFF (0) Locked panel operations are released (default).

Response Returns the key lock status in <NR1> format.

SYST:LOC

Switches the TOS5300 Series to local mode (panel operation). This is a substitute command for the IEEE 488.1 REN message (Remote Disable).

You can switch the TOS5300 Series back to remote mode by sending the SYST:REM or SYST:RWL command.

Command `SYSTem:LOCa1`

SYST:OPT

Queries the options that are installed in the TOS5300 Series. This command performs the same function as the *OPT? command.

Command `SYSTem:OPTion?`

Response Returns "0" if no options are installed. Returns one of the following responses in <character> format if options are installed.

Returns "RC0X-TOS" if an RC01-TOS, RC02-TOS, HP01A-TOS, or HP02A-TOS option is installed.

Returns "SIGNAL I/O" if a SIGNAL I/O option is installed.

Example If the RC01-TOS is installed,
this command returns "RC0X-TOS."

SYST:REM

Switches the TOS5300 Series to remote mode. All panel operations, except those of the LOCAL key and the STOP switch, are locked. This is a substitute command for the IEEE 488.1 REN message (Remote Enable). This is also the substitute command for address specification.

You can switch the TOS5300 Series back to local mode by sending the SYST:LOC command.

Command `SYSTem:REMOte`

SYST:RWL

Switches the TOS5300 Series to remote mode. Except for the STOP switch, all panel operations (including those of the LOCAL key) are locked. This is a substitute command for the IEEE 488.1 REN (Remote Enable) and LLO (Local Lock Out) messages.

You can switch the TOS5300 Series back to local mode by sending the SYST:LOC command. If you send the SYST:REM command, you can use the LOCAL key.

Command `SYSTem:RWLock`

SYST:VERS

Queries the version of the SCPI specifications that the TOS5300 Series complies with.

Command `SYSTem:VERSion?`

Response This command always returns 1999.0.

Status Register and Status Report Function

IEEE 488.2 and SCPI registers are used for status reports.

In each SCPI status register, there are the following sub registers: the CONDition register, the EVENT register, the ENABLE register, the PTRansition filter, and the NTRansition filter.

CONDition register

The CONDition register transmits automatically and reflects the condition of the TOS5300 Series in real time. Reading this register does not affect its contents.

EVENT register

The EVENT register bits are automatically set according to the changes in the CONDition register. The rule for setting the bits varies depending on the positive and negative transition filters (PTRansition and NTRansition). The EVENT register is reset when it is read.

ENABLE register

The ENABLE register enables reports to the summary bit or status bit of the event bits.

Transition filters

Use the PTRansition (positive transition) filter to report events when the condition changes from false to true.

Use the NTRansition (negative transition) filter to report events when the condition changes from true to false.

If both the positive filter and negative filter are set to true, events can be reported each time the status changes.

If both filters are cleared, event reporting is disabled.

Structure of SCPI status registers

1999 SCPI Syntax & Style

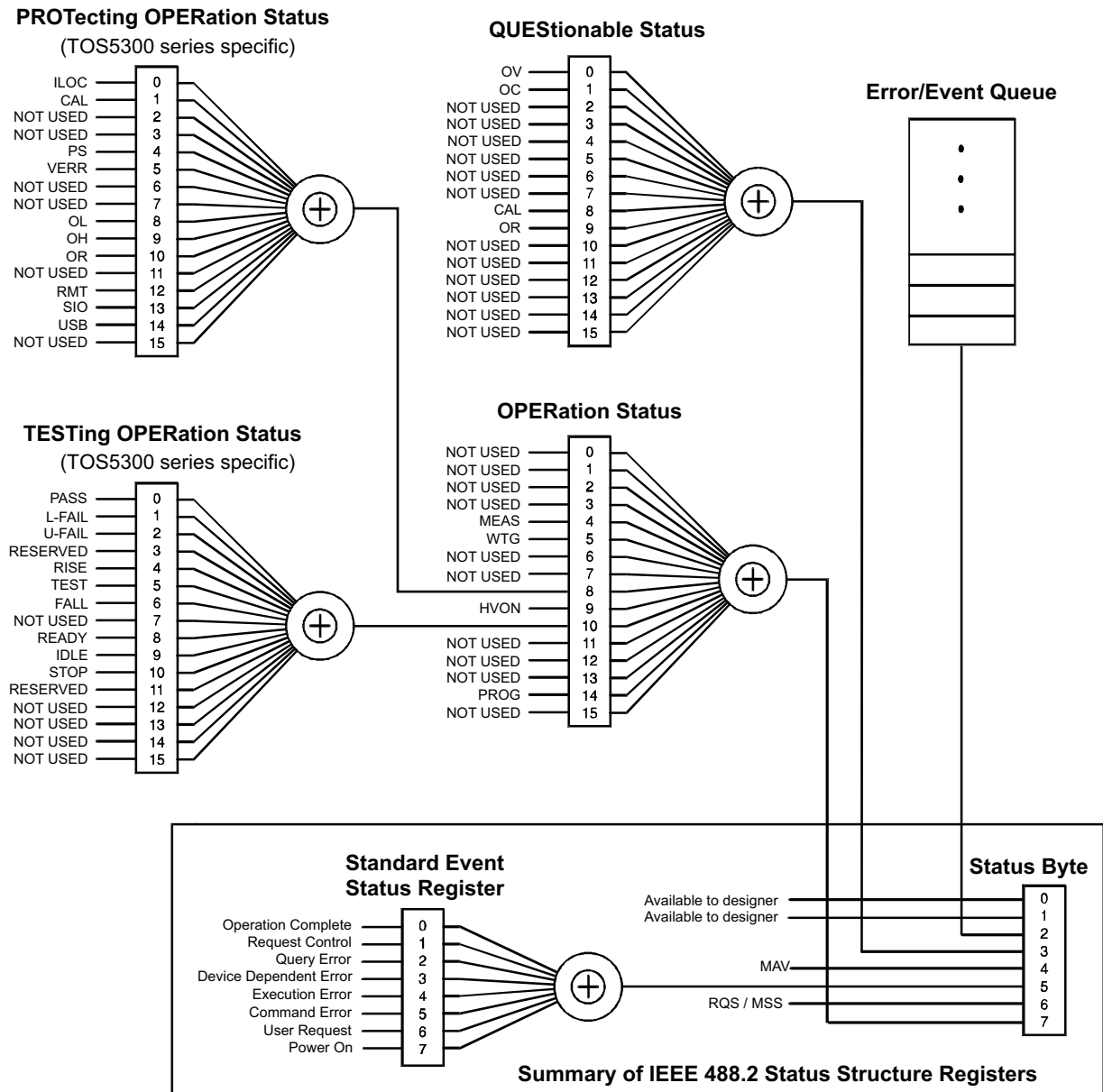

Partially changed SCPI Standard 1999.0 Volume 1 fig. 9-1

IEEE 488.2 Register Model

Status byte register

The status byte register stores STB and RQS (MSS) messages as defined by the IEEE 488.1 standard. The status byte register can be read by using IEEE 488.1 serial polling or the IEEE 488.2 common command *STB?.

When the controller executes serial polling, bit 6 responds with request service (RQS). The status byte value is not changed by serial polling.

*STB? makes the TOS5300 Series transmit the contents of the status byte register and the master status summary (MSS) message.

*STB? does not change the status byte, MSS, and RQS.

Bit	Bit weight	Bit name	Description
0	1	Reserved	Reserved for future use by IEEE 488. The bit value is notified as zero.
1	2	Reserved	
2	4	Error/Event Queue (EEQ)	If data exists in the error/event queue, this bit is set to true.
3	8	Questionable Status Register (QUES)	This bit is set to true when a bit is set in the QUEStionable event status register and the corresponding bit in the QUEStionable status enable register is true.
4	16	Message Available (MAV)	This bit is set to true when a request is received from the digital programming interface and the TOS5300 Series is ready to generate the data byte.
5	32	Standard Event Status Bit Summary (ESB)	This bit is set to true when a bit is set in the event status register.
6	64	Request Service (RQS)	This bit is set to true when a bit is set in the service request enable register and the corresponding bit exists in the status byte. The SRQ line of the USB is set.
		Master Status Summary (MSS)	This bit is set to true when any bit in the status byte register is set to 1 and the corresponding bit in the service request enable register is set to 1.
7	128	Operation Status Register (OPER)	This bit is set to true when a bit is set in the OPERation event status register and the corresponding bit in the OPERation status enable register is set.
8-15	—	NOT USED	—

Event status register (standard event status register)

The event status register bits are set when certain events occur during TOS5300 Series operation. All the event status register bits are set by the error/event queue.

This register is defined by the IEEE 488.2 standard and is controlled by the IEEE 488.2 common commands *ESE, *ESE?, and *ESR?.

Bit	Bit weight	Bit name	Description
0	1	Operation Complete (OPC)	Set when an *OPC command is received and all operations in standby have been completed.
1	2	Request Control (RQC)	—
2	4	Query Error (QYE)	Set when an attempt is made to read data from the output queue when there is no data or when the output queue is not in the wait state. This indicates that there is no data in the output queue.
3	8	Device Dependent Error (DDE)	Set when there is a device-specific error.
4	16	Execution Error (EXE)	Set when the TOS5300 Series evaluates that the program data after the header is outside the formal input range or does not match the specifications of the TOS5300 Series. This indicates that a valid SCPI command may not be executed correctly depending on the state of the TOS5300 Series.
5	32	Command Error (CME)	Set when an IEEE 488.2 syntax error is detected by the parser, when an unidentifiable header is received, or when a group execution trigger enters the internal IEEE 488.2 SCPI command input buffer.
6	64	User Request (URQ)	—
7	128	Power ON (PON)	Set when the power is turned on.
8-15	—	Reserved	—

SCPI Register Model

OPERation status register (STATus:OPERation)

The OPERation status register is a 16-bit register that contains information about the normal operating conditions of the TOS5300 Series.

Bit	Bit weight	Bit name	Description
0	1	NOT USED	—
1	2	NOT USED	—
2	4	NOT USED	—
3	8	NOT USED	—
4	16	MEASuring (MEAS)	Measurements are being performed (SEQ1)
5	32	Waiting for TRIGger (WTG)	Waiting for triggers
6	64	NOT USED	—
7	128	NOT USED	—
8	256	PROTeCting (PROT)	This bit is set to true when a bit is set in the PROTeCting status register.
9	512	High Voltage ON (HVON)	During testing or while voltage remains across the output terminals
10	1024	TESTing (TEST)	This bit is set to true when a bit is set in the TESTing status register.
11	2048	NOT USED	—
12	4096	NOT USED	—
13	8192	NOT USED	—
14	16384	PROGram is running (PROG)	During test execution (SEQ2)
15	32768	NOT USED	—

STAT:OPER

Queries the event of the OPERation status register.
A query clears the contents of the register.

Command `STATus:OPERation[:EVENT]?`

Response Returns the event of the OPERation status register in <NR1> format.

STAT:OPER:COND

Queries the condition of the OPERation status register.
A query does not clear the contents of the register.

Command `STATus:OPERation:CONDition?`

Response Returns the condition of the OPERation status register in <NR1> format.

STAT:OPER:ENAB

Sets the enable register of the OPERATION status register.

Command `STATus:OPERation:ENABle <NRf>`
`STATus:OPERation:ENABle?`

Parameter Value: 0 to 65535

Response Returns the enable register of the OPERATION status register in <NR1> format.

STAT:OPER:NTR

Sets the negative transition filter of the OPERATION status register.

Command `STATus:OPERation:NTRansition <NRf>`
`STATus:OPERation:NTRansition?`

Parameter Value: 0 to 65535

Response Returns the negative transition filter of the OPERATION status register in <NR1> format.

STAT:OPER:PTR

Sets the positive transition filter of the OPERATION status register.

Command `STATus:OPERation:PTRansition <NRf>`
`STATus:OPERation:PTRansition?`

Parameter Value: 0 to 65535

Response Returns the positive transition filter of the OPERATION status register in <NR1> format.

PROtecting status register (STATus:OPERation:PROtecting)

The PROtecting status register is a 16-bit register that contains information about the status of the TOS5300 Series protective features. This status register is unique to the TOS5300 Series.

Bit	Bit weight	Bit name	Description
0	1	Interlock (ILOCK)	Interlock signal input detected.
1	2	Calibration (CAL)	The set calibration date has passed.
2	4	NOT USED	—
3	8	NOT USED	—
4	16	Power Supply (PS)	Power supply problem detected.
5	32	Volt Error (VERR)	The output voltage exceeded the rated limits..
6	64	NOT USED	—
7	128	NOT USED	—
8	256	Over Load (OL)	The output power exceeded the output limit.
9	512	Over Heat (OH)	The internal temperature of the TOS5300 Series has become abnormally high.
10	1024	Over Rating (OR)	An output current was generated for a length of time that exceeds the rated time.
11	2048	NOT USED	—
12	4096	Remote (RMT)	A connection or disconnection of the remote control connector was detected.
13	8192	SIGNAL I/O (SIO)	A change in the SIGNAL I/O connector's ENABLE signal was detected.
14	16384	USB	A connection or disconnection of the USB cable while the TOS5300 Series was being controlled remotely was detected.
15	32768	NOT USED	—

STAT:OPER:PROT

Queries the event of the PROtecting status register.

A query clears the contents of the register.

Command STATus:OPERation:PROtecting[:EVENT]?

Response Returns the event of the PROtecting status register in <NR1> format.

STAT:OPER:PROT:COND

Queries the condition of the PROtecting status register.

A query does not clear the contents of the register.

Command STATus:OPERation:PROtecting:CONDition?

Response Returns the condition of the PROtecting status register in <NR1> format.

STAT:OPER:PROT:ENAB

Sets the enable register of the PROTECTing status register.

Command `STATus:OPERation:PROTECTing:ENABle <NRf>`
`STATus:OPERation:PROTECTing:ENABle?`

Parameter Value: 0 to 65535

Response Returns the enable register of the PROTECTing status register in <NR1> format.

STAT:OPER:PROT:NTR

Sets the negative transition filter of the PROTECTing status register.

Command `STATus:OPERation:PROTECTing:NTRansition <NRf>`
`STATus:OPERation:PROTECTing:NTRansition?`

Parameter Value: 0 to 65535

Response Returns the negative transition filter of the PROTECTing status register in <NR1> format.

STAT:OPER:PROT:PTR

Sets the positive transition filter of the PROTECTing status register.

Command `STATus:OPERation:PROTECTing:PTRansition <NRf>`
`STATus:OPERation:PROTECTing:PTRansition?`

Parameter Value: 0 to 65535

Response Returns the positive transition filter of the PROTECTing status register in <NR1> format.

TESTing status register (STATus:OPERation:TESTing)

The TESTing status register is a 16-bit register that contains information about the status of tests on the TOS5300 Series. This status register is unique to the TOS5300 Series.

Bit	Bit weight	Bit name	Description
0	1	PASS	PASS judgment
1	2	L-FAIL	L-FAIL judgment
2	4	U-FAIL	U-FAIL judgment
3	8	RESERVED	—
4	16	RISE	Voltage rising
5	32	TEST	Testing
6	64	FALL	Voltage falling
7	128	NOT USED	—
8	256	READY	Waiting for testing to start
9	512	IDLE	—
10	1024	STOP	Stopping testing
11	2048	RESERVED	—
12	4096	NOT USED	—
13	8192	NOT USED	—
14	16384	NOT USED	—
15	32768	NOT USED	—

STAT:OPER:TEST

Queries the event of the TESTing status register.
A query clears the contents of the register.

Command STATus:OPERation:TESTing[:EVENT]?

Response Returns the event of the TESTing status register in <NR1> format.

STAT:OPER:TEST:COND

Queries the condition of the TESTing status register.
A query does not clear the contents of the register.

Command STATus:OPERation:TESTing:CONDition?

Response Returns the condition of the TESTing status register in <NR1> format.

STAT:OPER:TEST:ENAB

Sets the enable register of the TESTing status register.

Command `STATus:OPERation:TESTing:ENABle <NRf>`
`STATus:OPERation:TESTing:ENABle?`

Parameter Value: 0 to 65535

Response Returns the enable register of the TESTing status register in <NR1> format.

STAT:OPER:TEST:NTR

Sets the negative transition filter of the TESTing status register.

Command `STATus:OPERation:TESTing:NTRansition <NRf>`
`STATus:OPERation:TESTing:NTRansition?`

Parameter Value: 0 to 65535

Response Returns the negative transition filter of the TESTing status register in <NR1> format.

STAT:OPER:TEST:PTR

Sets the positive transition filter of the TESTing status register.

Command `STATus:OPERation:TESTing:PTRansition <NRf>`
`STATus:OPERation:TESTing:PTRansition?`

Parameter Value: 0 to 65535

Response Returns the positive transition filter of the TESTing status register in <NR1> format.

QUESTionable status register (STATus:QUESTionable)

The QUESTionable status register is a 16-bit register that stores information related to the status of the TOS5300 Series and the questionable events that occur during TOS5300 Series operation.

These register bits may indicate that there are problems with the measured data of the TOS5300 Series.

Bit	Bit weight	Bit name	Description
0	1	Over Voltage (OV)	A voltage outside of the voltage measurement range was detected.
1	2	Over Current (OC)	A current outside of the current measurement range was detected.
2	4	NOT USED	—
3	8	NOT USED	—
4	16	NOT USED	—
5	32	NOT USED	—
6	64	NOT USED	—
7	128	NOT USED	—
8	256	CALibration (CAL)	The calibration date has passed.
9	512	Over Resistance (OR)	A resistance outside of the resistance measurement range was detected.
10	1024	NOT USED	—
11	2048	NOT USED	—
12	4096	NOT USED	—
13	8192	NOT USED	—
14	16384	NOT USED	—
15	32768	NOT USED	—

STAT:QUES

Queries the event of the QUESTionable status register.

A query clears the contents of the register.

Command `STATus:QUESTionable[:EVENT]?`

Response Returns the event of the QUESTionable status register in <NR1> format.

STAT:QUES:COND

Queries the condition of the QUESTionable status register.

A query does not clear the contents of the register.

Command `STATus:QUESTionable:CONDition?`

Response Returns the condition of the QUESTionable status register in <NR1> format.

STAT:QUES:ENAB

Sets the enable register of the QUEStionable status register.

Command `STATus:QUESTionable:ENABle <NRf>`
`STATus:QUESTionable:ENABle?`

Parameter Value: 0 to 65535

Response Returns the enable register of the QUEStionable status register in <NR1> format.

STAT:QUES:NTR

Sets the negative transition filter of the QUEStionable status register.

Command `STATus:QUESTionable:NTRansition <NRf>`
`STATus:QUESTionable:NTRansition?`

Parameter Value: 0 to 65535

Response Returns the negative transition filter of the QUEStionable status register in <NR1> format.

STAT:QUES:PTR

Sets the positive transition filter of the QUEStionable status register.

Command `STATus:QUESTionable:PTRansition <NRf>`
`STATus:QUESTionable:PTRansition?`

Parameter Value: 0 to 65535

Response Returns the positive transition filter of the QUEStionable status register in <NR1> format.

Preset status

STAT:PRES

Resets the ENABle register and the transition filters (PTRansition and NTRansition) of all status registers (including sub registers) to their default values.

Default values:

STATus:ENABle = 0x0000

STATus:PTRansition = 0x7FFF

STATus:NTRansition = 0x0000

Command `STATus:PRESet`

Performing tests

We will use an AC withstanding voltage test (ACW) to explain how to perform single operations.

Set the test conditions (test voltage, limit voltage, upper and lower limits, and test time):

```
SOUR:VOLT 1.5KV
SOUR:VOLT:PROT 2KV
SENS:JUDG 10MA
SENS:JUDG:LOW 0.01MA
SENS:JUDG:LOW:STAT ON
SOUR:VOLT:TIM 60S
SOUR:VOLT:TIM:STAT ON
```

Set additional test conditions (start voltage, voltage rise time, voltage fall time, and test voltage frequency):

```
SOUR:VOLT:STAR:STAT ON
SOUR:VOLT:SWE:TIM 5S
SOUR:VOLT:SWE:FALL:TIM:STAT OFF
SOUR:VOLT:FREQ 60HZ
```

After setting the test conditions, start the test.

First, set the mode to perform the test in:

```
SOUR:FUNC:MODE ACW
```

Start the test (in this example, we will just start the test without using any triggers).

When you send the INIT command, the test starts.

You cannot start the test if memory is being recalled or saved, the TOS5300 Series is in protection mode, or PASS/FAIL judgment is being performed.

```
TRIG:TEST:SOUR IMM
TEST:EXEC
```

You can query the voltage and current values during testing:

```
MEAS:CURR?
MEAS:VOLT?
```

Testing stops when the test time elapses (a PASS judgment), if a FAIL judgment occurs, or if the STOP switch is pressed. You can also end testing by sending the ABOR command, but the test results will be discarded. When testing finishes, you can query the test results (the overall judgment).

The condition of the OPER:TEST register is returned in NR1 format:

```
STAT:OPER:TEST:COND?
```



Appendix

- A List of Messages
- B List of Errors
- C Default State
- D Command processing time
- E Using Visual Basic 2008

A List of Messages

SCPI command: Command name in the short form.

Effect: "A" for commands that are affected by the *RST and *RCL commands. "B" for commands that are affected by the *RST command.

R/W: "R" for query commands and "W" for set commands.

Nt: "1" for SCPI standard commands, "2" for commands that are being reviewed, and "3" for original commands developed by Kikusui Electronics Corporation.

FETC subsystem

SCPI command		Setting		Default	Response	Effect	Description	R/W	Nt
Program header	Parameter		Unit						
FETC[:ARR]									
:CURR			A		NR3		Queries the measured current	R	3
:VOLT			V		NR3		Queries the measured voltage	R	3
:RES			Ω		NR3		Queries the measured resistance	R	3
:TIME			s		NR3		Queries the measured elapsed test time	R	3

INITiate subsystem

SCPI command		Setting		Default	Response	Effect	Description	R/W	Nt
Program header	Parameter		Unit						
INIT									
[:IMM]									
:NAME ACQ							Starts testing (starts the trigger function; SEQ1)	W	3
:NAME TEST							Starts testing (starts the trigger function; SEQ2)	W	3
:SEQ1							Starts testing (starts the trigger function; SEQ1)	W	3
:SEQ2							Starts testing (starts the trigger function; SEQ2)	W	3

MEASure / READ subsystem

SCPI command		Setting		Default	Response	Effect	Description	R/W	Nt
Program header	Parameter		Unit						
MEAS:ARR READ:ARR									
:CURR			A		NR3		Starts a new measurement and queries the current	R	3
:VOLT			V		NR3		Starts a new measurement and queries the voltage	R	3
:RES			Ω		NR3		Starts a new measurement and queries the resistance	R	3
:TIME			s		NR3		Starts a new measurement and queries the elapsed test time	R	3

RES subsystem

SCPI command		Setting		Default	Response	Effect	Description	R/W	Nt
Program header	Parameter		Unit						
RES[:IMM]					NR1, NR1, char, NR1, NR3, NR3, NR3, NR3, char		Queries the results of the previous test in the following order: test number, program number, test mode, test start time, measured voltage, measured current, measured resistance, test time, and judgment result.	R	3

SENSe subsystem

SCPI command		Setting			Default	Response	Effect	Description	R/W	Nt
Program header	Parameter		Unit							
SENS										
[:ACW]										
:JUDG[:UPP]	numeric	0.01 m to 110 m	A	0.02 m	NR3	A	Sets the upper limit	R/W	3	
:JUDG:LOW	numeric	0.01 m to 110 m	A	0.01 m	NR3	A	Sets the lower limit	R/W	3	
:STAT	bool			OFF	NR1	A	Turns the lower limit on and off	R/W	3	
:MODE	char	RMS AVE		RMS	char	B	Sets the measurement method	R/W	3	
:DCW:JUDG										
:UPP	numeric	0.01 m to 11 m	A	0.02 m	NR3	A	Sets the upper limit	R/W	3	
:LOW	numeric	0.01 m to 11 m	A	0.01 m	NR3	A	Sets the lower limit	R/W	3	
:STAT	bool			OFF	NR1	A	Turns the lower limit on and off	R/W	3	
:DEL	numeric	0.1 to 10.0	S	0.1	NR3	A	Sets the judgment wait time	R/W	3	
:IR										
:JUDG										
:DEL	numeric	0.1 to 10.0	S	0.1	NR3	A	Sets the judgment wait time	R/W	3	
:LOW	numeric	30 k to 5 G	Ω	1.00 M	NR3	A	Sets the lower limit	R/W	3	
:STAT	bool			ON	NR1	A	Turns the lower limit on and off	R/W	3	
:UPP	numeric	30 k to 5 G	Ω	100 M	NR3	A	Sets the upper limit	R/W	3	
:STAT	bool			OFF	NR1	A	Turns the upper limit on and off	R/W	3	
:MODE	char	FAS MID SLO		MID	char	A	Sets the current detection response speed that is used during upper limit judgment	R/W	3	

SOURce subsystem

SCPI command		Setting		Default	Response	Effect	Description	R/W	Nt
Program header	Parameter		Unit						
SOUR									
:FUNC:MODE	char	ACW DCW IR		ACW	char	A	Sets the test mode	R/W	3
[:ACW]:VOLT									
:FREQ	numeric	50 60	HZ	50	NR3	A	Sets the test voltage frequency	R/W	3
[:LEV]	numeric	0 to 5.5 k	V	0	NR3	A	Sets the test voltage	R/W	3
:PROT[:LEV][:UPP]	numeric	0 to 5.5 k	V	5.5k	NR3	A	Sets the limit voltage	R/W	3
:STAR:STAT	bool			OFF	NR1	A	Turns the start voltage on and off	R/W	3
:SWE									
:FALL:TIM:STAT	bool			OFF	NR1	A	Turns the voltage fall time on and off	R/W	3
[:RISE]:TIM	numeric	0.1 to 10.0	S	0.1	NR3	A	Sets the voltage rise time	R/W	3
:TIM	numeric	0.1 to 999.0	S	0.1	NR3	A	Sets the test time	R/W	3
:STAT	bool			ON	NR1	A	Turns on or off the feature that ends tests when their test time elapses	R/W	3
:DCW:VOLT									
[:LEV]	numeric	0 to 6.2 k	V	0	NR3	A	Sets the test voltage	R/W	3
:PROT[:LEV][:UPP]	numeric	0 to 6.2 k	V	6.2 k	NR3	A	Sets the limit voltage	R/W	3
:STAR:STAT	bool			OFF	NR1	A	Turns the start voltage on and off	R/W	3
:SWE[:RISE]:TIM	numeric	0.1 to 10.0	S	0.1	NR3	A	Sets the voltage rise time	R/W	3
:TIM	numeric	0.1 to 999.0	S	0.1	NR3	A	Sets the test time	R/W	3
:STAT	bool			ON	NR1	A	Turns on or off the feature that ends tests when their test time elapses	R/W	3
:IR:VOLT									
[:LEV]	numeric	25 50 100 125 250 500 1000	V	25	NR3	A	Sets the test voltage	R/W	3
:PROT[:LEV][:UPP]	numeric	25 50 100 125 250 500 1000	V	1000	NR3	A	Sets the limit voltage	R/W	3
:TIM	numeric	0.1 to 999.0	S	0.1	NR3	A	Sets the test time	R/W	3
:STAT	bool			ON	NR1	A	Turns on or off the feature that ends tests when their test time elapses	R/W	3

STATus subsystem

SCPI command		Setting		Default	Response	Effect	Description	R/W	Nt
Program header	Parameter		Unit						
STAT									
:OPER									
	[:EVEN]				NR1		Queries events ¹	R	1
	:COND				NR1		Queries register status ¹	R	1
	:ENAB	Nrf	0 to 65535		NR1		Enable ¹	R/W	1
	:NTR	Nrf	0 to 65535		NR1		Negative transition ¹	R/W	1
:PROT									
	[:EVEN]				NR1		Queries events ²	R	1
	:COND				NR1		Queries register status ²	R	1
	:ENAB	Nrf	0 to 65535		NR1		Enable ²	R/W	1
	:NTR	Nrf	0 to 65535		NR1		Negative transition ²	R/W	1
	:PTR	Nrf	0 to 65535		NR1		Positive transition ²	R/W	1
	:PTR	Nrf	0 to 65535		NR1		Positive transition ¹	R/W	1
:TEST									
	[:EVEN]				NR1		Queries events ³	R	1
	:COND				NR1		Queries register status ³	R	1
	:ENAB	Nrf	0 to 65535		NR1		Enable ³	R/W	1
	:NTR	Nrf	0 to 65535		NR1		Negative transition ³	R/W	1
	:PTR	Nrf	0 to 65535		NR1		Positive transition ³	R/W	1
	:PRES						Resets filter registers to default values	W	1
:QUES									
	[:EVEN]				NR1		Queries events ⁴	R	1
	:COND				NR1		Queries register status ⁴	R	1
	:ENAB	Nrf	0 to 65535		NR1		Enable ⁴	R/W	1
	:NTR	Nrf	0 to 65535		NR1		Negative transition ⁴	R/W	1
	:PTR	Nrf	0 to 65535		NR1		Positive transition ⁴	R/W	1

- 1 OPERation status register
- 2 PROTeCting status register
- 3 TESTing status register
- 4 QUEStionable status register

SYSTEM subsystem

SCPI command		Setting		Default	Response	Effect	Description	R/W	Nt	
Program header	Parameter		Unit							
SYST										
:CONF										
:BEEP:VOL										
	:FAIL	numeric	0.0 to 1.0		0.5	NR3	B	Sets the volume level of the buzzer that is sounded when a FAIL judgment occurs	R/W	3
	:PASS	numeric	0.0 to 1.0		0.3	NR3	B	Sets the volume level of the buzzer that is sounded when a PASS judgment occurs	R/W	3
	:CAL:DUE:CONT	numeric	3 to 36	month	12	NR1	B	Sets the calibration period	R/W	3
	:DATE	NR1	2000 to 2099			NR1		Sets the date (year)	R/W	3
		NR1	1 to 12			NR1		Sets the date (month)		
		NR1	1 to 31			NR1		Sets the date (day)		
	:PHOL	numeric	50m 100m 200m 1 2 5 INF	s	50m	NR3	B	Sets the PASS judgment result hold time	R/W	3
	:TIME	NR1	0 to 23			NR1		Sets the time (hour)	R/W	3
		NR1	0 to 59			NR1		Sets the time (minutes)		
		NR1	0 to 59			NR1		Sets the time (seconds)		
	:ERR[:NEXT]							Queries error and event information	R	1
	:KLOC	bool			OFF	NR1	B	Locks and unlocks panel operations	R/W	3
	:LOC							Switches to local mode	W	2
	:OPT					0 1		Queries options	R	3
	:REM							Switches to remote mode; locks all keys other than LOCAL and the STOP switch	W	2
	:RWL							Switches to remote mode; locks all keys other than the STOP switch	W	2
	:VERS					1 999.0		Queries the version of the compliant SCPI specifications	R	1

TEST subsystem

SCPI command		Setting		Default	Response	Effect	Description	R/W	Nt	
Program header	Parameter		Unit							
TEST										
	:ABOR							Aborts testing (SEQ2)	W	3
	:EXEC							Starts testing (starts the trigger function; SEQ2)	W	3
	:PROT:CLE							Clears protection mode	W	3

TRIGger subsystem

SCPI command		Setting		Default	Response	Effect	Description	R/W	Nt	
Program header	Parameter		Unit							
TRIG[:SEQ[1]] TRIG[:ACQ] (sequence 1, ACQUIRE)										
	[:IMM]							Executes a software trigger (SEQ1)	W	1
	:COUN	numeric	1 to 100		1	NR3	B	Executes a test with the applicable trigger count (SEQ1)	R/W	3
	:SOUR	char	IMM BUS TIM TEST		IMM	char	B	Sets the trigger source (SEQ1)	R/W	3
	:TIM	numeric	1 to 60.0	S	0	NR3	B	Sets the trigger timer (SEQ1)	R/W	3
TRIG:SEQ2 TRIG:TEST (sequence 2, TEST)										
	[:IMM]							Executes a software trigger (SEQ2)	W	1
	:SOUR	char	IMM BUS EXT		IMM	char	B	Sets the trigger source (SEQ2)	R/W	3

Other subsystems

SCPI command		Setting		Default	Response	Effect	Description	R/W	Nt
Program header	Parameter		Unit						
ABOR							Aborts testing or measurements	W	1

IEEE 488.2 common commands

IEEE488.2 common commands	Parameter	Description	R/W
*CLS		Clears all the event registers.	W
*ESE	NR1	Sets the event status enable register bits.	R/W
*ESR		Queries the event status register.	R
*IDN		Queries the identification string (manufacturer information).	R
*OPC		Causes the TOS5300 Series to generate the operation complete message in the event status register when all pending device operations have finished.	R/W
*OPT		Queries the options that are installed in the TOS5300 Series.	R
*PSC	0 1	Sets whether the *ESE and *SRE settings will be cleared.	R/W
*RCL	NR1	Loads the settings that have been stored to memory.	W
*RST		Performs a device reset. Configures the TOS5300 Series to a known condition independent from the usage history of the device.	W
*SAV	NR1	Saves the current settings to memory.	W
*SRE	NR1	Sets the service request enable register.	R/W
*STB		Queries the contents of the status byte register and the master summary status message.	R
*TRG		Trigger command.	W
*TST		Executes a self-test.	R
*WAI		Prevents the TOS5300 Series from executing subsequent commands or queries until all pending operations have completed.	W

B List of Errors

Command errors

An error in the range [-199, -100] indicates that an IEEE 488.2 syntax error has been detected by the instrument's parser. The occurrence of any error in this class causes the Command Error bit (bit 5) in the event status register to be set.

Error code	Error message description	
-100	Command error	Generic syntax error.
-101	Invalid character	A syntactic element contains an invalid character.
-102	Syntax error	An unrecognized command or data type was encountered.
-103	Invalid separator	The parser was expecting a separator and encountered an illegal character.
-104	Data type error	The parser recognized a data element different than one allowed.
-105	GET not allowed	A Group Execute Trigger was received in a program message.
-108	Parameter not allowed	More parameters were received than expected for the header.
-109	Missing parameter	Fewer parameters were received than required for the header.
-110	Command header error	An error was detected in the header.
-120	Numeric data error	Generated when parsing a data element which appears to be numeric, including the nondecimal numeric types.
-130	Suffix error	Generated when parsing a suffix.
-131	Invalid suffix	The suffix does not follow the syntax, or the suffix is inappropriate for the TOS5300 Series.
-134	Suffix too long	The suffix contained more than twelve characters.
-138	Suffix not allowed	A suffix was encountered after a numeric element that does not allow suffixes.
-140	Character data error	Generated when parsing a character data element.
-141	Invalid character data	Either the character data element contains an invalid character, or the element is not valid.
-144	Character data too Long	The character data element contains more than twelve characters.
-148	Character data not allowed	A legal character data element was encountered where prohibited by the TOS5300 Series.
-150	String data error	Generated when parsing a string data element.
-160	Block data error	Generated when parsing a block data element.
-170	Expression error	Generated when parsing an expression data element.
-180	Macro error	Generated when defining a macro or executing a macro.

Execution errors

An error in the range [-299, -200] indicates that an error has been detected by the instrument's execution control block. The occurrence of any error in this class causes the Execution Error bit (bit 4) in the event status register to be set.

Error code		Error message description
-200	Execution error (generic)	A generic TOS5300 Series error.
-201	Operation denied while TEST is running	The setting is not reflected during the measurement.
-203	Command protected	Password protected program or query command cannot be executed.
-210	Trigger error	A trigger error.
-211	Trigger ignored	A trigger was received but ignored.
-213	Init ignored	A measurement initiate operation was ignored because measurement is in progress.
-214	Trigger deadlock	A deadlock occurred because a query was received before the software trigger.
-220	Parameter error	A program data element related error occurred.
-221	Settings conflict	A command was received that the TOS5300 Series cannot execute in its current condition.
-222	Data out of range	Program value was outside the legal range.
-223	Too much data	Too many parameters were received for the requirements.
-224	Illegal parameter value	Received invalid parameter data.
-230	Data corrupt or stale	Received a data query before the measurement completed.
-241	Hardware missing	Cannot be executed because the optional hardware is not installed.

Device-specific errors

Error code		Error message description
-330	Self-test failed	The self-test failed.
-360	Communication error	A communication error occurred.
-361	Parity error in program message	A parity bit was incorrect.
-362	Framing error in program message	The stop bit cannot be detected.
-363	Input buffer overrun	An overrun occurred in the input buffer.
-365	Time out error	A time out error occurred.

Query errors

An error in the range [-499, -400] indicates that the output queue control of the instrument has detected a problem with the message exchange protocol described in IEEE 488.2, chapter 6. The occurrence of any error in this class causes the Query Error bit (bit 2) in the event status register to be set.

Error code		Error message description
-400	Query error (generic)	A generic TOS5300 Series error.
-410	Query INTERRUPTED	Received a new command before the response was read.
-420	Query UNTERMINATED	The controller attempted to read the response after the device received an unsupported query or has not received a query. The -100 "Command error" and this error are stored in the error/event queue. The controller will time out.
-430	Query DEADLOCKED	The error queue, input buffer, and output buffer are full when sending large binary data as a response, and the transmission timing is off.
-440	Query UNTERMINATED after indefinite response	Received a separate query in semicolon-delimited format after a query that returns a response in an indefinite form. Example: *IDN? ; SYST:ERR?

Operation complete event errors

An error in the range [-899, -800] is used when the TOS5300 Series wants to report an IEEE 488.2 operation complete event. This event occurs when the instrument's synchronization protocol, having been enabled by an *OPC command, completes all selected pending operations.

The occurrence of this event causes the Operation Complete bit (bit 0) in the event status register to be set.

Error code		Error message description
-800	Operation complete	All selected pending operations in accordance with the IEEE 488.2, 12.5.2 synchronization protocol have been completed.

C Default State

When the TOS5300 Series is initialized at the factory or when it receives an *RST or *RCL command, its settings are set to the values shown in the following table.

When the power is turned on, the settings are set to the values that were in use immediately before the POWER switch was turned off.

Item		Command	Setting after initialization	Setting after command received	
				*RST	*RCL
Withstanding voltage test conditions (ACW)	Measurement method	SENS:MODE	RMS	←	No change
	Test voltage	SOUR:VOLT	0 V	←	Depends on the settings in memory
	Test voltage limit	SOUR:VOLT:PROT	5.5 kV		
	Start voltage on and off	SOUR:VOLT:STAR:STAT	OFF		
	Voltage rise time	SOUR:VOLT:SWE:TIM	0.1 s		
	Voltage fall time on and off	SOUR:VOLT:SWE:FALL:TIM:STAT	OFF		
	Upper limit	SENS:JUDG	0.02 mA		
	Lower limit	SENS:JUDG:LOW	0.01 mA		
	Lower limit on and off	SENS:JUDG:LOW:STAT	OFF		
	Test time	SOUR:VOLT:TIM	0.1 s		
	Test timer on and off	SOUR:VOLT:TIM:STAT	ON		
	Test voltage frequency	SOUR:VOLT:FREQ	50 Hz		
Withstanding voltage test conditions (DCW)	Test voltage	SOUR:DCW:VOLT	0 V		
	Test voltage limit	SOUR:DCW:VOLT:PROT	6.2 kV		
	Start voltage on and off	SOUR:DCW:VOLT:STAR:STAT	OFF		
	Voltage rise time	SOUR:DCW:VOLT:SWE:TIM	0.1 s		
	Upper limit	SENS:DCW:JUDG	0.02 mA		
	Lower limit	SENS:DCW:JUDG:LOW	0.01 mA		
	Lower limit on and off	SENS:DCW:JUDG:LOW:STAT	OFF		
	Test time	SOUR:DCW:VOLT:TIM	0.1 s		
	Test time on and off	SOUR:DCW:VOLT:STAT	ON		
	Judgment wait time	SENS:DCW:JUDG:DEL	0.1 s		
Insulation resistance test conditions (IR)	Test voltage	SOUR:IR:VOLT	25 V	←	Depends on the settings in memory
	Test voltage limit	SOUR:IR:VOLT:PROT	1000 V		
	Upper limit	SENS:IR:JUDG	100 MΩ		
	Upper limit on and off	SENS:IR:JUDG:STAT	OFF		
	Lower limit	SENS:IR:JUDG:LOW	1.00 MΩ		
	Lower limit on and off	SENS:IR:JUDG:LOW:STAT	ON		
	Test time	SOUR:IR:VOLT:TIM	0.1 s		
	Test time on and off	SOUR:IR:VOLT:TIM:STAT	ON		
	Judgment wait time	SENS:IR:JUDG:DEL	0.1 s		
	Current detection response speed	SENS:IR:MODE	Mid		
Test mode	ACW voltage test/ DCW voltage test/ Insulation resistance test	SOUR:FUNC:MODE	ACW	←	Depends on the settings in memory

Item		Command	Setting after initialization	Setting after command received	
				*RST	*RCL
Trigger source	(SEQ1)	TRIG:SOUR	IMM	←	No effect
	(SEQ2)	TRIG:SEQ2:SOUR/ TRIG:TEST:SOUR	IMM		
Trigger count (SEQ1)		TRIG:COUN	1		
Trigger timer (SEQ1)		TRIG:TIM	0	No change	0 (default value)
PASS judgment result hold time		SYST:CONF:PHOL	50	←	No effect
Buzzer volume	PASS judgment	SYST:CONF:BEEP:VOL:PASS	0.3	←	No change
	FALL judgment	SYST:CONF:BEEP:VOL:FAIL	0.5		
Set the calibration period		SYST:CONF:CAL:DUE:CONT	12	←	No change



D Command processing time

A certain amount of time is required before the commands shown in the following table are received by the TOS5300 Series.

The processing times shown here are standard values, not guaranteed values.

The processing times vary depending on the settings and the measurement conditions.

The values shown below do not include hardware response times.

Command	USB processing time (ms)	Description
SOUR:FUNC:MODE ACW	2	Sets the test mode
SOUR:VOLT 1kV	2	Sets the test voltage
SOUR:VOLT:TIM 1S	2	Sets the test time
SENS:JUDG 5mA	2	Sets the upper limit
MEAS:VOLT?	20	Starts a new measurement and queries the voltage
STAT:OPER:TEST:COND?	3	Queries register status

App

E Using Visual Basic 2008

This appendix will explain how to use Visual Basic 2008 and the VISA library to communicate with the TOS5300 Series through its USB interface.

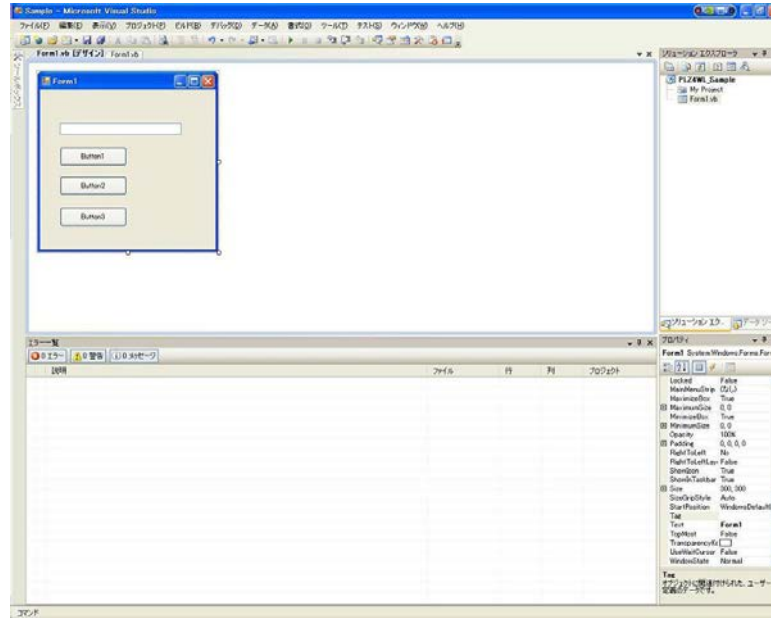

Project settings

First, specify a driver for performing communications (the VISA library) in the project settings. On the Project menu, click Add Reference, and then click "VISA COM3.0 Type Library."

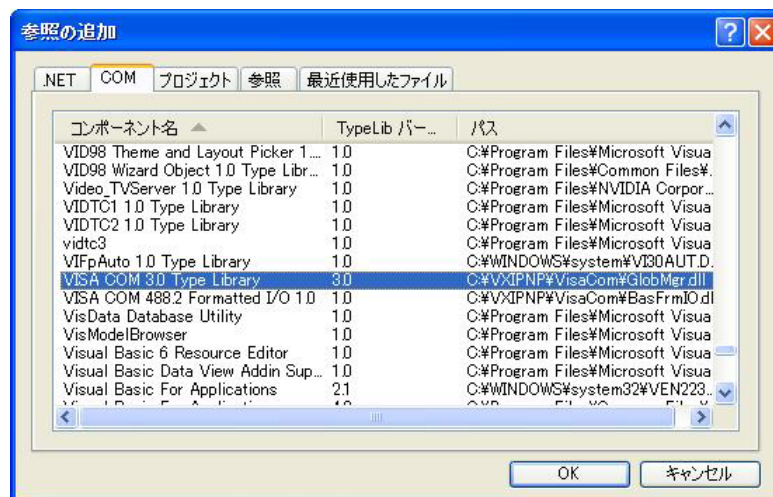

Communicating through USB

After you finish making the communications driver setting, you can perform communications through USB.

We will explain the communications procedure that uses the VISA library.

■ Opening VISA

Before you can use the VISA library to communicate with the USB feature, you have to open VISA. Specify an I/O resource to open VISA.

Example: Opening VISA to communicate over USB

```
Set rm = CreateObject("VISA.GlobalRM")
Set msg = rm.Open("USB::0x0B3E::0x1017::00000001::INSTR", NO_LOCK, 0, "")
```

"USB::0x0B3E::0x1017::00000001::INSTR" is an I/O resource.

The I/O resource syntax is shown below. The parts surrounded by square brackets ([]) can be omitted. Enter the appropriate values in the parts written in italics.

USB[*board*]::VendorID::ProductID::SerialNumber[::InterfaceNumber]::INSTR]

Example: A USNTMC measuring instrument whose vendor ID (VID) is 0x0B3E, product ID (PID) is 0x1017, and serial number is 00000001

```
USB0::0x0B3E::0x1017::00000001::INSTR
```

In VISA, you can use aliases for I/O resources.

If you use an alias for an I/O resource, even if the alias name is hard-coded in the application, the I/O resource name can still be changed to an appropriate value when the application runs.

Example: Using an alias (MYDEV1) for an I/O resource

```
Set msg = rm.Open("MYDEV1", NO_LOCK, 0, "")
```

When you use aliases, specify the actual I/O resources through an external configuration table or similar tool. The following figure shows an example of using KI-VISA with the USB interface.

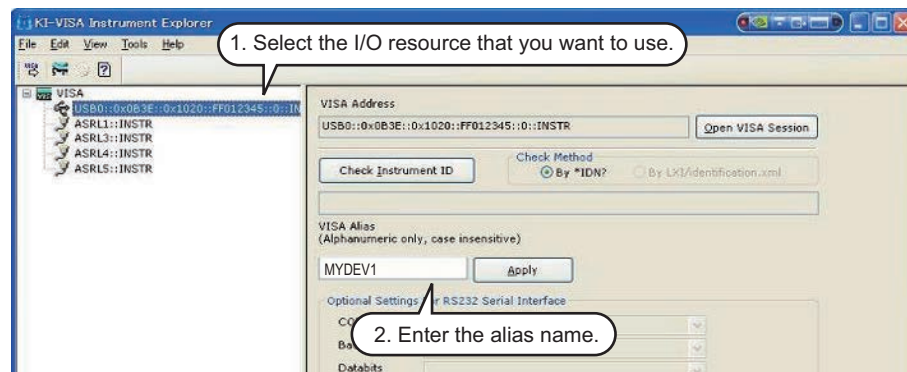

If you are using a version of VISA other than KI-VISA, see the manual of your VISA version.

■ Controlling the instrument

Next, we will use commands such as read and write commands to control the instrument.

Example: <code>msg.WriteString ("SOUR:VOLT 1.5KV")</code>	'Sets the test voltage to 1.5 kV
<code>msg.WriteString ("SOUR:VOLT:PROT 2KV")</code>	'Sets the limit voltage to 2 kV
<code>msg.WriteString ("SENS:JUDG 10MA")</code>	'Sets the upper limit for judgments to 10 mA

■ Closing VISA

Finally, close VISA.

In a sequence of operations, you only have to open and close VISA once.

```
msg.Close
```

Sample program

```
Imports Ivi.Visa.Interop

Public Class Form1

    Dim rm As ResourceManager
    Dim msg As IMessage

    Private Sub Form1_Load(ByVal sender As System.Object, ByVal e As System.EventArgs) Handles MyBase.Load
        rm = CreateObject("VISA.GlobalRM")
        'msg = rm.Open("MYDEV1", AccessMode.NO_LOCK, 0, "") 'Version using a VISA alias
        'msg = rm.Open("USB0::0x0B3E::0x1017::FF012345::INSTR", AccessMode.NO_LOCK, 0, "") 'Version using USB
    End Sub

    'Queries the ID
    Private Sub cmdIdn_Click(ByVal sender As System.Object, ByVal e As System.EventArgs) Handles cmdIdn.Click
        msg.WriteString("*IDN?")
        TextBox1.Text = msg.ReadString(256)
    End Sub

    'Sets the test voltage, limit voltage, and upper limit for judgments
    Private Sub cmdCurr_Click(ByVal sender As System.Object, ByVal e As System.EventArgs) Handles cmdCurr.Click
        msg.WriteString("SOUR:VOLT 1.5KV") 'Sets the test voltage to 1.5 kV
        msg.WriteString("SOUR:VOLT:PROT 2KV") 'Sets the limit voltage to 2 kV
        msg.WriteString("SENS:JUDG 10MA") 'Sets the upper limit for judgments to 10 mA
    End Sub

    'Queries the measured values
    Private Sub cmdMeas_Click(ByVal sender As System.Object, ByVal e As System.EventArgs) Handles cmdMeas.Click
        msg.WriteString("MEAS:VOLT?") 'Queries the measured voltage
        TextBox1.Text = msg.ReadString(256) 'Reads 256 bytes of data from the reception buffer, converts the
        'string into a number, and assigns the converted value to a
        'variable

        msg.WriteString("MEAS:CURR?") 'Queries the measured current
        TextBox1.Text = msg.ReadString(256) 'Reads 256 bytes of data from the reception buffer, converts the
        'string into a number, and assigns the converted value to a
        'variable

        msg.WriteString("MEAS:RES?") 'Queries the measured resistance
        TextBox1.Text = msg.ReadString(256) 'Reads 256 bytes of data from the reception buffer, converts the
        string into a number, and assigns the converted value to a variable

    End Sub

    Private Sub Form1_Disposed(ByVal sender As Object, ByVal e As System.EventArgs) Handles Me.Disposed
        msg.Close()
    End Sub
End Class
```

INDEX

B	
Boolean data	12
C	
character data	12
commands	
description	16
hierarchy	10
processing time	71
syntax	10
units	13
common commands	12, 17
CONDition register	46
E	
ENABLE register	46
EVENT register	46
event status register	49
I	
IEEE Std 488.2	6
interface	6
L	
list of errors	66
M	
messages	10
list	60
N	
NRF	13
Numeric	13
O	
OPERation status register	50
P	
parameters	12
PROTecting status register	52
Q	
queries	11
QUESTionable status register	56
R	
remote control	
list of errors	66
remote interface	6
ROM version	1
S	
sample program	74
SCPI	6, 10
status byte register	48
status register	46
string data	12
T	
terminator	12
TESTing status register	54
transition filters	46
tutorial	58
U	
USB interface	6
V	
version	1
VISA library	7



If you find any misplaced or missing pages in the manuals, they will be replaced. If the manual gets lost or soiled, a new copy can be provided for a fee. In either case, please contact your Kikusui agent or distributor. At that time, inform your agent or distributor of the "Part No." written on the front cover of this manual.

Every effort has been made to ensure the accuracy of this manual. However, if you have any questions or find any errors or omissions, please contact your Kikusui agent or distributor.

After you have finished reading this manual, store it so that you can use it for reference at any time.

KIKUSUI ELECTRONICS CORP.

1-1-3 Higashiyamata, Tsuzuki-ku, Yokohama,
224-0023, Japan

Tel: +81-45-482-6353

Fax: +81-45-482-6261

www.kikusui.co.jp/en

