

# Communication Interface Manual

## Withstanding Voltage Tester TOS5200

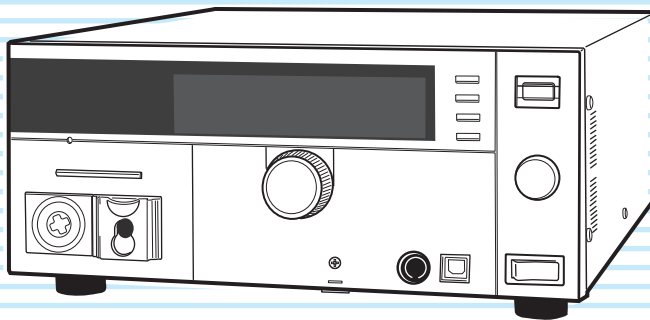

### **DANGER**

#### **This product generates high voltage!**

- Improper operation can lead to serious accidents.
- To prevent accidents, be sure to read the section “Safety Precautions during Testing” in this manual.
- Keep this manual close to the product so that the operators can read the manual at any time.

<b>Remote Control</b>	<b>5</b>
Remote Control Overview	6
Installing the VISA Library	7
Using the USB Interface	8
Using the RS232C Interface	9
Talk Mode	11
<b>Message Overview</b>	<b>13</b>
Message Overview	14
<b>Command Reference</b>	<b>19</b>
Command Description in This Manual	20
IEEE 488.2 Common Commands	21
Test Mode Settings	24
AC Withstanding Voltage Test Conditions	25
About Sequences	29
Test Execution (SEQUENCE2:TEST)	31
Querying Measured Values (SEQUENCE1:ACQUIRE)	33
Various Settings	37
Status Register and Status Report Function	40
IEEE 488.2 Register Model	42
SCPI Register Model	44
TOS5050A Commands	52
Tutorial	56
<b>Appendix</b>	<b>57</b>
List of Messages	58
List of Errors	63
Default State	66
Command Processing Time	67
Using Visual Basic 2008	68

## About the Manuals

These manuals are intended for users of the Withstanding Voltage Tester and their instructors. Explanations are given under the presumption that the reader has knowledge related to electricity.

### Manual construction

#### ■ Setup Guide

This manual is intended for first-time users of the product. It gives an overview of the product, connecting procedures, safety precautions, etc. Please read this manual before you operate the product.

#### ■ Quick Reference

The quick reference briefly explains the control panel and the basic operation of it.

#### ■ Safety Information

This document contains general safety precautions for this product. Keep them in mind and make sure to observe them.

#### ■ User's Manual (PDF)

This manual is intended for first-time users of this product. It provides an overview of the product, notes on usage, and specifications. It also explains how to connect the product, configure the product, operate the product, perform maintenance on the product, and so on.

#### ■ Communication Interface Manual (this manual, PDF)

This manual explains how to control the product remotely using SCPI commands.

The interface manual is written for readers with sufficient basic knowledge of how to control measuring instruments using a PC.

PDF files are included in the accompanying CD-ROM. Adobe Reader is required to view the PDF files.

The newest version of the operation manual can be downloaded from Download service of Kikusui website.

### Firmware versions that this manual covers

This manual covers firmware versions 1.0X.

When contacting us about the product, please provide us with:

Model (marked in the top section of the front panel)

The firmware version (see the user's manual)

The serial number (marked in the bottom section of the rear panel)

### Before reading this manual

First read the User's Manual, which includes information on the product's hardware, to avoid connecting or operating the product incorrectly.

## Trademarks

Microsoft, Windows, and Visual Basic are registered trademarks of Microsoft Corporation in the United States and/or other countries.

All company names and product names used in this manual are trademarks or registered trademarks of their respective companies.

## Copyrights

The contents of this manual may not be reproduced, in whole or in part, without the prior consent of the copyright holder.

The specifications of this product and the contents of this manual are subject to change without prior notice.

© 2014 Kikusui Electronics Corporation

## Notations Used in This Manual

- The TOS5200 Withstanding Voltage Tester is also referred to as the TOS5200.
- Device under test is also referred to as DUT.
- The term "PC" is used to refer generally to both personal computers and workstations.
- The following markings are used in the explanations in this manual.

#### **NOTE**

Indicates information that you should know.

#### **See**

Indicates a reference to detailed information.



Indicates the hierarchy of items you need to select.

#### **★ Memo**

Indicates useful information.

# Contents

	About the Manuals .....	2
	Notations Used in This Manual .....	2
	Contents .....	3
<b>1</b>	<b>Remote Control</b>	
	Remote Control Overview .....	6
	Installing the VISA Library .....	7
	Using the USB Interface .....	8
	Using the RS232C Interface .....	9
	Talk Mode .....	11
<b>2</b>	<b>Message Overview</b>	
	Message Overview .....	14
	SCPI command syntax .....	14
	Parameters .....	16
<b>3</b>	<b>Command Reference</b>	
	Command Description in This Manual .....	20
	IEEE 488.2 Common Commands .....	21
	Test Mode Settings .....	24
	AC Withstanding Voltage Test Conditions .....	25
	Measurement mode setting .....	25
	Test voltage setting .....	25
	Limit voltage setting .....	25
	Upper limit setting .....	26
	Lower limit setting .....	26
	Test time setting .....	27
	Start voltage setting .....	27
	Voltage rise time setting .....	28
	Voltage fall time setting .....	28
	Test voltage frequency setting .....	28
	About Sequences .....	29
	Test Execution (SEQUENCE2:TEST) .....	31
	Querying Measured Values (SEQUENCE1:ACQUIRE) .....	33
	Various Settings .....	37
	PASS judgment result hold time setting .....	37
	Buzzer volume settings .....	37
	Other settings .....	38
	Status Register and Status Report Function .....	40
	IEEE 488.2 Register Model .....	42
	Status byte register .....	42
	Event status register (standard event status register) .....	43
	SCPI Register Model .....	44
	OPERation status register (STATUS:OPERation) .....	44
	PROTECTing status register (STATUS:OPERation:PROTECTing) .....	46
	TESTing status register (STATUS:OPERation:TESTing) .....	48
	QUESTionable status register (STATUS:QUESTionable) .....	50
	Preset status .....	51
	TOS5050A Commands .....	52
	Tutorial .....	56

Performing tests ..... 56

## Appendix

A List of Messages ..... 58  
B List of Errors ..... 63  
C Default State ..... 66  
D Command Processing Time ..... 67  
E Using Visual Basic 2008 ..... 68

Index..... 71





# 1

---

## Remote Control

This chapter provides a general explanation of the remote control function.

# Remote Control Overview

In addition to controlling the TOS5200 from the front panel, you can control it remotely through the following interfaces.

- USB interface
- RS232C interface

You cannot use the USB and RS232C interfaces at the same time.

If cables are connected to both USB and RS232C ports, the USB interface takes precedence. The remote interfaces comply with IEEE Std 488.2-1992 and SCPI Specification 1999.0.

When the product is being controlled remotely, “RMT” appears on the front-panel screen. To switch the TOS5200 back to local mode from the front panel, press LOCAL.

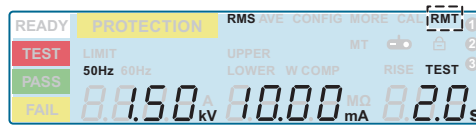

## ■ Measuring instrument interface standards

The TOS5200 complies with the following standards.

- IEEE Std 488.2-1992 IEEE Standard Codes, Formats, Protocols, and Common Commands For Use With IEEE Std 488.1-1987
- IEEE Std 488.1-1987 IEEE Standard Digital Interface for Programmable Instrumentation
- IEEE Std 1174-2000 IEEE Standard Serial Interface for Programmable Instrumentation
- Standard Commands for Programmable Instruments (SCPI) version 1999.0
- Universal Serial Bus Specification Rev 2.0
- Universal Serial Bus Test and Measurement Class Specification (USBTMC) Rev 1.0
- Universal Serial Bus Test and Measurement Class, Subclass USB488 Specification (USBTMC-USB488) Rev 1.0

# Installing the VISA Library

VISA (Virtual Instrument Software Architecture) is a specification for standard software that is used to connect instruments. VISA was defined by the IVI Foundation.

A VISA library is required to use the software application. The VISA library (NI-VISA, Keysight VISA, or KI-VISA) must be installed on the controller (Windows).

One of the VISA libraries (driver software implemented in compliance with the VISA specifications) below is necessary.

- NI-VISA by National Instruments (Ver. 5.1.1 or later)
- Keysight VISA by Keysight Technologies (Keysight IO Libraries Suite 16.0 or later)
- KI-VISA Ver. 5.0.4 or later

---

## NOTE

- Do not install multiple VISA libraries on the same PC. Doing so may cause errors.
  - If NI-VISA or Keysight VISA is already installed on your PC, you do not need to install KI-VISA.
- 

KI-VISA is an original VISA library developed by Kikusui Electronics Corporation that supports the IVI VISA specifications 5.0. You can download the most recent version of this library from the Kikusui Electronics Corporation website (<https://www.kikusui.co.jp/en/download/>).

# Using the USB Interface

To use the USB interface to control the product, a device driver that supports the USB Test & Measurement Class (USBTMC) must be installed on the controller. The USBTMC driver is installed automatically by the VISA library.

---

**NOTE**

Noise may be generated by problems such as the outputs being shorted or the DUT insulation being damaged. This noise may cause errors in the remote control communication. To reduce the effect of noise, keep the USB cable at least 30 cm away from the test leads and the DUT.

---

## USB feature

- Complies with USB specification 2.0
- Complies with USBTMC specification 1.0 and USBTMC-USB488 specification 1.0
- Baud rate: 12 Mbps maximum (full speed)
- VID (vendor ID): 0x0B3E
- PID (product ID): 0x1046

## Service request

The TOS5200 is equipped with service request and serial polling functions.





# Using the RS232C Interface

The TOS5200 RS232C port is a standard D-sub, 9-pin male connector.

Check that the TOS5200 and your PC are off, and connect them with a standard crossover cable (null-modem cable).

Use a D-sub, 9-pin, female-to-female AT crossover cable. The port pinout is shown below.

The TOS5200 does not use hardware handshaking, so not all the pins need to be connected (crossover cable wiring diagram).

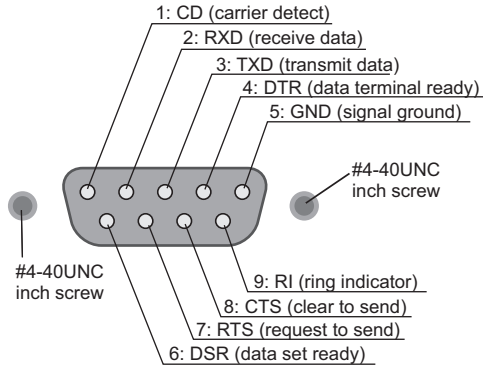

When you are facing the TOS5200 rear panel

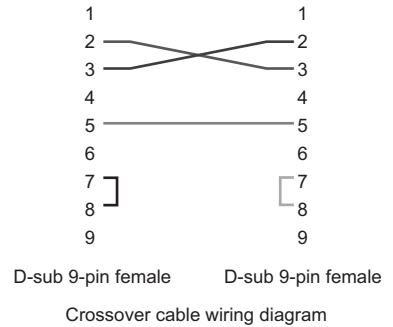

## RS232C settings

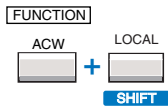

**1 Press CONFIG (SHIFT+FUNCTION) to display the CONFIG setup screen.**  
The CONFIG **1** screen appears.

**2 Press MEMORY 2 or MEMORY 3 to move to the Baudrate setting, and then use the rotary knob to set the value.**

To exit from the CONFIG setup screen and return to the basic setup screen, press STOP.

Example: Selecting the baudrate (blinking)

Baudrate setting [0: 9 600, 1: 19 200, 2: 38 400, 3: 57 600, 4: 115 200]

## Protocol

The RS232C protocol is shown in the following table. The underlined value is the factory default setting. The values in parentheses are CONFIG setting options.

Item	Value
Communication system	Start-stop synchronization
Baudrate	<u>9600 bps</u> / 19200 bps/ 38400 bps/ 57600 bps/ 115200 bps (0/ 1/ 2/ 3/ 4)
Data length	8 bits
Parity	None
Stop bits	1 bit
Flow control	Fixed to XFLOW

**NOTE**

Several bytes of characters may be transmitted when the power is turned on. Turn on the PC or serial printer after turning on the TOS5200.

## RS232C transmission and reception

Device Control (DC) codes are used for control codes. Data may not be transmitted (or received) properly if flow control is not used.

Code	Function	ASCII code
DC1 (Xon)	Request to send	11H
DC3 (Xoff)	Request to stop sending	13H

Transmission control from the TOS5200 to the RS232-C terminal

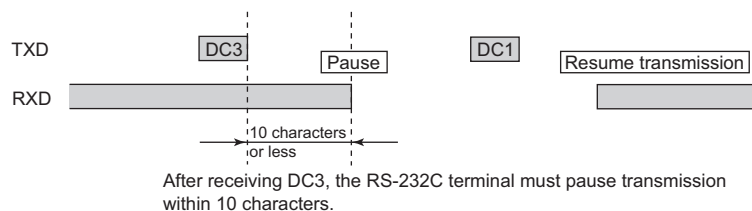

## Break signal

The break signal is used as a substitute for the IEEE488.1 dcl/sdc (Device Clear, Selected Device Clear) message.

**NOTE**

To use the RS232C interface, a "SYSTem:REMOte" command must be sent to set the TOS5200 to remote mode. To use remote programming, send "SYSTem:REMOte" at the beginning of the program.

# Talk Mode

This feature enables you to control the product in the same manner as remote control without using commands from a PC. It can reduce processing on the PC.

If you turn talk mode on, you cannot control the product from a PC. To control the product from a PC, turn talk mode off.

Talk mode	Description
OFF (0)	Responds only to commands from a PC (default)
ON (1)	Automatically responds at the start and end of a test. The TOS5200 status, settings, and measured values are returned.
	Response at the start of a test
	<START>
	Response at the end of a test
Status	<PASS>, <U_FAIL>, <L_FAIL>, <PROT>, or <STOP>
Settings, measured values	Measured voltage, measured current, test time

## Setting the talk mode

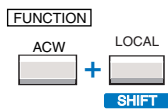

**1 Press CONFIG (SHIFT+FUNCTION) to display the CONFIG setup screen.**  
Pressing once shows the CONFIG ① screen.

**2 Press MEMORY 2 or MEMORY 3 to move to the talk mode setting, and then use the rotary knob to set the value.**

To exit from the CONFIG setup screen and return to the basic setup screen, press STOP.

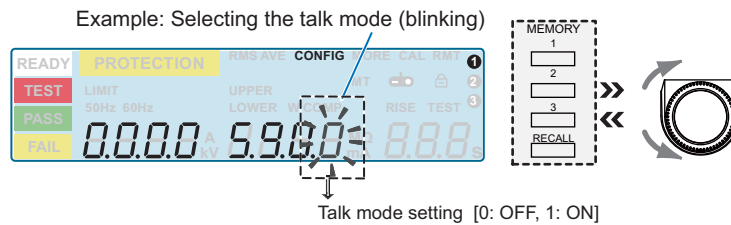

**NOTE**

- If the TOS5200 is initialized, the talk mode is set to “0.”
- Even when the talk mode is set to “0” with the \*RST command, it will return to the setting specified by the panel when the TOS5200 is restarted.



This page is intentionally blank.





# 2

---

## Message Overview

This chapter gives an overview of remote control messages. It then explains topics such as the make-up of the SCPI commands that are used for remote control and the command syntax.

# Message Overview

The information that is transferred between the controller (the PC) and the TOS5200 is referred to as “messages.”

The TOS5200 uses the SCPI language for these messages.

The TOS5200 can also use Kikusui TOS5050A commands.

The messages that the PC sends to the TOS5200 are commands. The messages that the TOS5200 sends to the PC are responses.

Commands are used to execute functions or change settings on the TOS5200 or to query its settings or status. Responses are used to return the product’s settings or status.

## SCPI command syntax

### Command hierarchy

SCPI is an ASCII-based command language that was designed for test and measuring equipment. The command structure is composed of the common roots and nodes that are the building blocks of the SCPI subsystem. A command consists of a program header, parameters, and punctuation marks.

The following table uses the SYSTem subsystem as an example to explain the hierarchy.

Program header	Parameter	Node level
:SYSTem		Root node
:CONFigure		2nd level
:BEEPer		3rd level
:VOLume		4th level
:FAIL	<numeric>	5th level
:PASS	<numeric>	5th level
:ERRor		2nd level
[:NEXT]	<code>, “<description>”	3rd level

- A colon (:) separates a higher node from a lower node.

### Command syntax

In this manual, SCPI commands are expressed in the following format.

Example:

```
SYSTem:CONFigure:BEEPer:VOLume:PASS {<numeric>|MINimum|MAXimum}
```

- SCPI commands can be written in long form (with all the characters) or in short form (omitting the lowercase characters).  
SCPI commands can be transmitted in either long form or short form.
- SCPI commands are not case sensitive. VOLT, Volt, and volt are all received as the short form of the VOLTage command.  
VOLUME, Volume, and volume are all received as the long form of the VOLume command.
- A space separates a program header and its parameters.
- Multiple parameters are separated by commas.

- Compound commands can be created by concatenating two commands with a semicolon.

Example:

```
SYSTem:CONFigure:BEEPer:VOLume:FAIL MINimum;PASS MINimum
```

You can use a compound command to send a command that is the same as the two following commands.

```
SYSTem:CONFigure:BEEPer:VOLume:FAIL MINimum
```

```
SYSTem:CONFigure:BEEPer:VOLume:PASS MINimum
```

In the first command (SYSTem:CONFigure:BEEPer:VOLume:FAIL), SYSTem:CONFigure:BEEPer:VOLume is set as the path. Therefore, in the second command, SYSTem:CONFigure:BEEPer:VOLume can be omitted.

If you specify a node that is not defined in the current path (except for FAIL and PASS), an error will occur.

- Program headers are separated by colons.
- By using colons and semicolons, you can concatenate commands of different subsystems.

Example:

```
SENSe:JUDGment MINimum;:SOURce:VOLTage?
```

There are two root nodes in this compound command: SENSe and SOURce.

When the second command or later begins with a colon, the path that was specified by the previous command is cleared.

- The maximum length of a command that you can transmit on a single line is 128 bytes.

### Special symbols and characters

The special symbols and characters that are used in this manual for the SCPI command syntax are explained below.

Symbol or character	Description
< >	Character strings inside the < and > symbols indicate program data. Do not include the < and > symbols in the actual program.
{ }	Characters and numbers delimited by " " inside the { and } symbols indicate that one of the delimited items is to be selected. Do not include the { and } symbols in the actual program.
[ ]	Character strings inside [ and ] indicate optional data. When optional data is not sent with the program, the default value is sent. Do not include the [ and ] symbols in the actual program.

### Queries

You can query the TOS5200 settings and status.

To make a query, append a question mark to the end of the program header section. If the query has parameters, insert a space after the question mark, and then write the parameters.

Example:

```
VOLTage? MINimum
```

**NOTE**

If you want to send two queries on separate lines, send the second query after you have received the response to the first one. If you send query commands on two lines at the same time, you may receive an incomplete response.

## Terminating character strings

All commands must be terminated with a valid terminator.

The available terminators are <line feed> (ASCII 0x0A) and EOI (end-or-identify).

You can use any one of these terminators to terminate a command.

When you terminate a command string, the path is reset to the root level.

**NOTE** CR (ASCII 0x0D) is not a terminator.

## Common commands

See p. 21

There are commands that are common to the IEEE-488.2 and SCPI standards for functions such as resetting devices and performing self-diagnoses. These common commands start with an asterisk (\*). These commands may have one or multiple parameters.

## Parameters

The SCPI parameter format is derived from the program parameter format that is defined in IEEE 488.2.

The program data expression format that the TOS5200 uses is shown below.

## Non-numeric parameters

The TOS5200 uses the following three parameter types.

Symbol or character	Description
String data (String)	Used when a series of ASCII characters are requested. Be sure to enclose strings in single or double quotation marks. The opening and closing quotation marks must match (you cannot mix single and double quotation marks). Example: <code>PROGram:NAME "ACW2IR"</code> If you want to include a quotation mark as part of the string, enter consecutive quotation marks (with no characters between them). ASCII codes 20H to 7EH can be used in strings.
Character data (Character)	Used when only a limited number of values are available for a program setting. Responses are returned in short form. Example: <code>TRIGger:SOURce {IMMediate BUS TIMer TEST}</code>
Boolean data (Boolean)	Used to express a condition of 1 or 0, or ON or OFF. Responses are returned as 1 or 0. Example: <code>SOURce:VOLTage:TIMer:STATe {ON OFF 1 0}</code>



## Numeric parameters

The TOS5200 uses the following five parameter types.

Symbol or character	Description
NR1	Represents an integer value. <sup>1</sup>
NR2	Represents a real number in floating-point format. <sup>1</sup>
NR3	Represents a real number in scientific notation. <sup>1</sup> If the 380 is returned in the response data, it is returned as +3.80000E+02. Five decimal places are used.
NRf	NRf is a generic term that includes NR1, NR2, and NR3.
Numeric	Represents values such as the decimal point, optional prefixes, and measurement units. Numbers are expressed the same as NRf. MINimum, MAXimum, and the like are available as substitutes for declaring certain values. You can also use units such as V, A, and S in numeric parameters. If a value that cannot be assigned is entered, the TOS5200 rounds the value to the closest possible value. Example: <code>SYSTem:CONFigure:BEEPer:VOLume:PASS 2.0</code> <code>SYST:CONF:BEEP:VOL:PASS</code> must be set to a value from 0.0 to 0.9, so even if you attempt to set the value to 2.0, it will be set to 0.9.

<sup>1</sup> Details are given in the “IEEE 488.2 Standard Digital Interface for Programmable Instrumentation.”

## Special form numeric parameters

The special form numeric parameters MINimum and MAXimum can be used as substitutes for the actual maximum and minimum values when the parameter is numeric.

The following example sets the volume level of the buzzer that is sounded when a PASS judgment occurs to the minimum value.

**SYSTem:CONFigure:BEEPer:VOLume:PASS MINimum**

You can query the minimum and maximum values for most parameters.

**SOURce:VOLTage:PROTection? MAXimum**

## Measurement units

The default measurement units are listed below. Commands are accepted even if measurement units are not specified.

- A (current)
- V (voltage)
- OHM (resistance)
- S (seconds)
- HZ (frequency)

The following optional prefixes are supported. If you use optional prefixes, specify the measurement unit.

- G (giga)
- MA (mega)
- K (kilo)
- M (milli)
- U (micro)

To enter “μ” in the parameter, use “U.” When the measurement unit is “HZ” or “OHM” and you enter “M” in the parameter, the unit will be “mega.”

**NOTE**

The unit symbols in the International System of Units contain lowercase characters. The IEEE standard uses uppercase characters. SCPI commands are not case sensitive.

This page is intentionally blank.





# 3

---

## Command Reference

This chapter explains topics such as command details and registers.

# Command Description in This Manual

In this manual, SCPI commands are described in the following manner.

Append the value that you want to set the setting to after the command.  
To set the test voltage of an AC withstanding voltage test (ACW) to 5.5 kV, send SOUR:VOLT 5.5KV.

## SOUR:VOLT

Commands that have these marks are affected when an \*RST or \*RCL command is sent. The settings for the command are changed to the values that are shown in the "Default values" section. The test voltage is changed to 0 volts when the \*RST command is sent.

\*RST \*RCL

Sets the test voltage.

The commands are listed in the long form. The lowercase characters can be omitted. Sections that are enclosed in braces ( [ ] ) can also be omitted.

The parameters are listed. In this command, the parameter is numeric. In addition to specifying the desired value, you can specify the minimum or maximum value.

**Command** SOURce [ : ACW ] : VOLTage [ : LEVel ] { <numeric> | MIN | MAX }  
SOURce [ : ACW ] : VOLTage [ : LEVel ] ? { MIN | MAX }

The setting range is listed. Optional symbols such as m and  $\mu$  can also be used.

Specify MAX to set the maximum value.

Parameter Value: 0 to 5.5K (The default value is 0.)

The unit for the value being set. The unit can be omitted.

Specify MIN to set the minimum value.

Unit: V

**Response** Returns the test voltage in <NR3> format.

The format of the value that is returned when a query is sent.

### References to command descriptions

Item	See
Command syntax	p. 14
Parameters	p. 16
Units	p. 17
Queries	p. 15
Expression format	p. 16
List of messages	p. 58
List of errors	p. 63
Command processing time	p. 67

# IEEE 488.2 Common Commands

## \*CLS

 p. 40  
IEEE 488.2-1992  
section 10.3

Clears all event registers including the status byte, event status, and error queue.

**Command** \*CLS

## \*ESE

 p. 43  
IEEE 488.2-1992  
section 10.10

Sets the event status enable register that is counted by the event summary bit (ESB) of the status byte.

**Command** \*ESE <NR1>  
\*ESE?

**Parameter** Value: 0 to 255  
An SCPI error (-222, "Data out of range") occurs if the specified value is outside the range.

**Example** When \*ESE 16 is transmitted, bit 4 of the event status enable register is set. Each time the execution error bit (bit 4) of the event status register is set, the summary bit (ESB) of the status byte is set.

**Response** Returns the value of the event status enable register in <NR1> format.

## \*ESR

 p. 43  
IEEE 488.2-1992  
section 10.12

Event  
Queries the status register. Registers that are read are cleared.

**Command** \*ESR?

**Response** Returns the value of the event status register in <NR1> format and clears the register.

## \*IDN

 p. 43  
IEEE 488.2-1992  
section 10.14

Queries the model name, serial number, and firmware version of the TOS5200.

**Command** \*IDN?

**Response** The response to \*IDN? is indicated below.

**Example** For a TOS5200 with serial number AB123456 and firmware version 1.00, \*IDN? returns:

KIKUSUI, TOS5200, AB123456, 1.00

**\*OPC**IEEE 488.2-1992  
section 10.18

Sets the OPC bit (bit 0) of the event status register when all the commands that are in standby have been processed.

**Command** \*OPC  
\*OPC?

**Response** Returns "1" when all the commands that are in standby have been processed.

**\*OPT**

Queries the options that are installed in the TOS5200. This command performs the same function as the SYSTem:OPTion? command.

**Command** \*OPT?

**Response** Returns "0" if no options are installed. Returns one of the following responses in <character> format if options are installed.

Returns "RC0X-TOS" if an RC01-TOS, RC02-TOS, HP01A-TOS, or HP02A-TOS option is installed. Returns "SIGNAL I/O" if a SIGNAL I/O option is installed.

**Example** If the RC01-TOS is installed,  
this command returns "RC0X-TOS."

**\*PSC**IEEE 488.2-1992  
section 10.25

Sets whether the event status enable register and service request enable register are cleared when the POWER switch is turned on.

**Command** \*PSC <NR1>  
\*PSC?

Parameter	Value:	0	When the POWER switch is turned on, the *ESE and *SRE settings are not cleared.
		1	When the POWER switch is turned on, the *ESE and *SRE settings are cleared.

An SCPI error (-222, "Data out of range") occurs if the specified value is outside the range.

**Example** To enable the power-on SRQ feature:

```
*PSC 0;*SRE 32;*ESE 128
```

**Response** Returns the power-on status setting in response to the PSC? query.

**\*RCL**

Aborts test execution and measurement and loads the settings that have been saved to memory.



p. 66

For the commands that are affected by \*RCL, see "Default State".

**Command** \*RCL <NR1>

Parameter	Value:	1 to 3	Memory number
-----------	--------	--------	---------------

An SCPI error (-222, "Data out of range") occurs if the specified value is outside the range.

**\*RST**

 p. 66  
IEEE 488.2-1992  
section 10.32

Aborts test execution and measurement and resets the panel settings to their default values. For the commands that are affected by \*RST, see "Default State".

**Command** \*RST

**\*SAV**

 p. 66

Saves the present settings to memory. The settings that are saved are the same as those that will be loaded with the \*RCL command. For details, see "Default State".

**Command** \*SAV <NR1>

Parameter Value: 1 to 3 Memory number  
An SCPI error (-222, "Data out of range") occurs if the specified value is outside the range.

**\*SRE**

 p. 42  
IEEE 488.2-1992  
section 10.34

Sets the service request enable register.

The service request enable register can be used to select which summary messages in the status byte register will perform service requests.

To clear the service request enable register, send \*SRE 0. If the register is cleared, service requests cannot be generated by status information.

**Command** \*SRE <NR1>  
\*SRE?

Parameter Value: 0 to 255  
An SCPI error (-222, "Data out of range") occurs if the specified value is outside the range.

Example Sending \*SRE 8 sets bit 3 of the service request enable register. Each time the summary bit (bit 3) of the QUESTIONable status register in the status byte is set, a service request message is generated.

**Response** Returns the value of the service request enable register in <NR1> format.

**\*STB**

 p. 42  
IEEE 488.2-1992  
section 10.36

Queries the contents of the status byte register and the MSS (master summary status) message.

The response is the same as serial polling only with the exception that the MSS message appears in place of the RQS message in bit 6.

**Command** \*STB?

**Response** Returns the value of the status byte register and the MSS message (bit 6) in <NR1> format.

### \*TRG

 See  
IEEE 488.2-1992  
section 10.37

Trigger command.

This is a substitute command for the IEEE 488.1 get message (Group Execute Trigger). If the TOS5200 is in a state in which it does not accept triggers, an SCPI error (-211, "Trigger ignored") occurs.

**Command** \*TRG

### \*TST

 See  
IEEE 488.2-1992  
section 10.38

Executes a self-test. You can query which error occurred by sending the SYST:ERR? command.

**Command** \*TST?

**Response** Returns "0" if no errors are detected. Returns the error code if an error is detected.

### \*WAI

 See  
IEEE 488.2-1992  
section 10.39

Prevents the TOS5200 from executing subsequent commands until all operations that are in standby have completed.

**Command** \*WAI

## Test Mode Settings

### SOUR:FUNC:MODE

[\\*RST](#) [\\*RCL](#)

Set the test mode. This is fixed to ACW.

**Command** SOURce:FUNCtion:MODE ACW  
SOURce:FUNCtion:MODE?

Parameter Value: ACW AC withstanding voltage test

**Response** This command always returns ACW.



# AC Withstanding Voltage Test Conditions

These are commands for setting the AC withstanding voltage test conditions.

## Measurement mode setting

### SENS:MODE

\* RST

Sets the measurement mode.

**Command** SENSE[:ACW]:MODE {RMS|AVE}  
SENSE[:ACW]:MODE?

Parameter	Value:	RMS	True rms response (default)
		AVE	Mean-value response

**Response** Returns the measurement mode in <character> format.

## Test voltage setting

### SOUR:VOLT

\* RST \* RCL

Sets the test voltage.

**Command** SOURCE[:ACW]:VOLTage[:LEVel] {<numeric>|MIN|MAX}  
SOURCE[:ACW]:VOLTage[:LEVel]? {MIN|MAX}

Parameter	Value:	0 to 5.5 k (The default value is 0.)
	Unit:	V

**Response** Returns the test voltage setting in <NR3> format.

## Limit voltage setting

### SOUR:VOLT:PROT

\* RST \* RCL

Sets the limit voltage.

**Command** SOURCE[:ACW]:VOLTage:PROTection[:LEVel][:UPPer] {<numeric>|MIN|MAX}  
SOURCE[:ACW]:VOLTage:PROTection[:LEVel][:UPPer]? {MIN|MAX}

Parameter	Value:	0 to 5.5 k (The default value is 5.5 k.)
	Unit:	V

**Response** Returns the limit voltage in <NR3> format.

## Upper limit setting

### SENS:JUDG

\* RST \* RCL

Sets the upper limit that is used in judgments (UPPER).

**Command** `SENSe[:ACW]:JUDGment[:UPPer] {<numeric>|MIN|MAX}`  
`SENSe[:ACW]:JUDGment[:UPPer]? {MIN|MAX}`

Parameter Value: 0.01 m to 110 m (The default value is 0.02 m.)  
 Unit: A

**Response** Returns the upper limit in <NR3> format.

## Lower limit setting

### SENS:JUDG:LOW

\* RST \* RCL

Sets the lower limit that is used in judgments (LOWER). This setting is enabled when SENS:JUDG:LOW:STAT is set to ON.

**Command** `SENSe[:ACW]:JUDGment:LOWer {<numeric>|MIN|MAX}`  
`SENSe[:ACW]:JUDGment:LOWer? {MIN|MAX}`

Parameter Value: 0.01 m to 110 m (The default value is 0.01 m.)  
 Unit: A

**Response** Returns the lower limit in <NR3> format.

### SENS:JUDG:LOW:STAT

\* RST \* RCL

Sets whether the lower limit is used in judgments (LOWER ON/OFF). Use SENS:JUDG:LOW to set the lower limit.

**Command** `SENSe[:ACW]:JUDGment:LOWer:STATe {ON|OFF|1|0}`  
`SENSe[:ACW]:JUDGment:LOWer:STATe?`

Parameter Value: ON (1) The limit is used in judgments.  
 OFF (0) The limit is not used in judgments (default).

**Response** Returns whether the lower limit is used in judgments in <NR1> format.

## Test time setting

### SOUR:VOLT:TIM

\* RST \* RCL

Sets the test time (TIMER). This setting is enabled when SOUR:VOLT:TIM:STAT is set to ON.

**Command** SOURce[:ACW]:VOLTage:TIMer {<numeric>|MIN|MAX}  
SOURce[:ACW]:VOLTage:TIMer? {MIN|MAX}

Parameter Value: 0.1 to 999.0 (The default value is 0.1.)  
Unit: s

**Response** Returns the test time in <NR3> format.

### SOUR:VOLT:TIM:STAT

\* RST \* RCL

Sets whether to stop testing after the set test time elapses (TIMER ON/OFF). Use SOUR:VOLT:TIM to set the test time.

**Command** SOURce[:ACW]:VOLTage:TIMer:STATe {ON|OFF|1|0}  
SOURce[:ACW]:VOLTage:TIMer:STATe?

Parameter Value: ON (1) Testing is stopped after the test time elapses (default).  
OFF (0) Testing is not stopped after the test time elapses.

**Response** Returns whether testing is stopped after the test time elapses in <NR1> format.

## Start voltage setting

### SOUR:VOLT:STAR:STAT

\* RST \* RCL

Sets whether the start voltage is used. The start voltage is 50 % of the test voltage.

**Command** SOURce[:ACW]:VOLTage:STARt:STATe {ON|OFF|1|0}  
SOURce[:ACW]:VOLTage:STARt:STATe?

Parameter Value: ON (1) The start voltage is used.  
OFF (0) The start voltage is not used (default).

**Response** Returns whether the start voltage is used in <NR1> format.

## Voltage rise time setting

### SOUR:VOLT:SWE:TIM

\* RST \* RCL

Sets the voltage rise time (Rise Time).

**Command** SOURce [:ACW] :VOLTage :SWEep [:RISE] :TIMer {<numeric>|MIN|MAX}  
SOURce [:ACW] :VOLTage :SWEep [:RISE] :TIMer? {MIN|MAX}

Parameter Value: 0.1 to 10.0 (The default value is 0.1.)  
Unit: s

**Response** Returns the voltage rise time (Rise Time) in <NR3> format.

## Voltage fall time setting

### SOUR:VOLT:SWE:FALL:TIM:STAT

\* RST \* RCL

Sets whether the voltage fall time (Fall Time) is used.

**Command** SOURce [:ACW] :VOLTage :SWEep :FALL :TIMer :STATe {ON|OFF|1|0}  
SOURce [:ACW] :VOLTage :SWEep :FALL :TIMer :STATe?

Parameter Value: ON (1) The voltage fall time (Fall Time) is used.  
OFF (0) The voltage fall time (Fall Time) is not used (default).

**Response** Returns whether the voltage fall time (Fall Time) is used in <NR1> format.

## Test voltage frequency setting

### SOUR:VOLT:FREQ

\* RST \* RCL

Sets the test voltage frequency.

**Command** SOURce [:ACW] :VOLTage :FREQuency {<numeric>|MIN|MAX}  
SOURce [:ACW] :VOLTage :FREQuency? {MIN|MAX}

Parameter Value: 50, 60 (The default value is 50.)  
Unit: HZ

**Response** Returns the test voltage frequency in <NR3> format.

# About Sequences

Sequences are used to perform withstanding voltage tests and measurements. The front-panel STOP switch remains enabled during remote control.

A sequence has three states: IDLE, INITiated, and WTG.

## IDLE state

When the TOS5200 is on, all sequences are in the IDLE state. In this state, the trigger subsystem ignores all triggers. If you send the ABOR, \*RST, or \*RCL command, the trigger subsystem is switched to the IDLE state, regardless of its current state.

If you send the TRG command while the TOS5200 is in the IDLE state, tests will not be performed.

## INITiated state

When you send the INIT command while the TOS5200 is in the IDLE state, the trigger function begins operating, and the tester switches to the INITiated state.

If the trigger source is set to IMMEDIATE, testing or measurements begin immediately.

If the trigger source is set to BUS or EXTERNAL, the TOS5200 switches to the WTG (Waiting for Trigger) state.

If the SEQUENCE1 (ACQUIRE) trigger source is set to TIMER, measurements begin after the trigger timer's set time elapses.

If the SEQUENCE1 (ACQUIRE) trigger source is set to TEST, measurements begin at the start of tests.

## WTG (Waiting for Trigger) state

If you send a trigger while the TOS5200 is in the WTG state, testing or measurements begin.

If the trigger source is set to BUS, send a software trigger.

If the SEQUENCE2 (TEST) trigger source is set to EXTERNAL, use the START switch to begin testing.

SEquence2 (TEST) trigger function flowchart

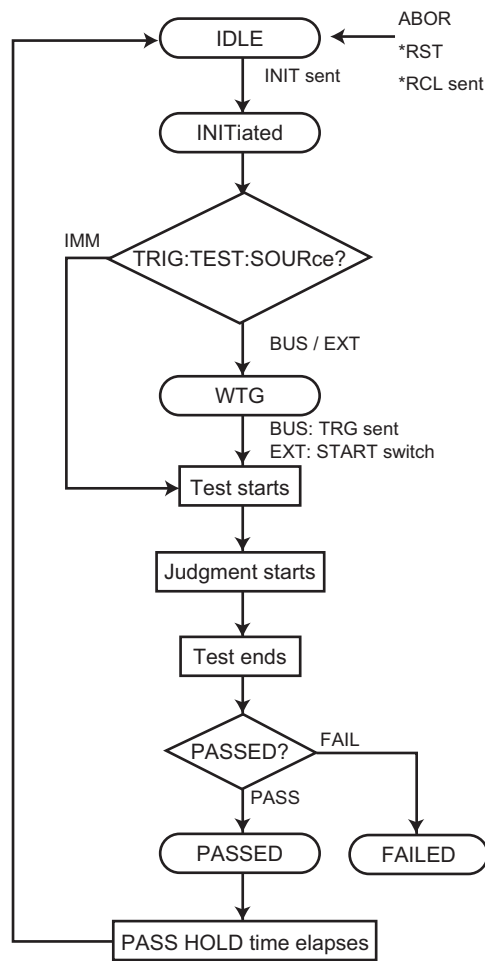

The TOS5200 has the following two trigger functions.

- SEquence1 (ACQuire)  
Starts measurements and queries measured values.
- SEquence2 (TEST)  
Executes tests. You have to specify the execution conditions in advance.

# Test Execution (SEQUENCE2:TEST)

This function executes tests. You have to specify the execution conditions in advance.

## NOTE

If the double action feature or momentary feature is set to ON, tests do not start even when you send trigger commands.

In the panel CONFIG settings, set the double action feature or momentary feature to OFF.

## TRIG:SEQ2:SOUR/ TRIG:TEST:SOUR

\*RST

Sets the trigger source to apply to the SEQUENCE2 (TEST) group.

**Command** TRIGger:SEQuence2:SOURce {IMMediate|BUS|EXTernal}  
TRIGger:SEQuence2:SOURce?  
TRIGger:TEST:SOURce {IMMediate|BUS|EXTernal}  
TRIGger:TEST:SOURce?

Parameter	Value:	IMMediate	Begin a test immediately (default).
		BUS	Wait for a software trigger—a *TRG, TRIG, or IEEE 488.1 get (Group Execute Trigger) command—and then begin a test.
		EXTernal	Begin testing when the START switch is pressed.

**Response** Returns the trigger source in <character> format.

## INIT:SEQ2/ INIT:NAME TEST/ TEST:EXEC

Starts a test (starts the trigger function). Use the trigger source that was set with TRIG:SEQ2:SOUR or TRIG:TEST:SOUR to start the test.

**Command** INITiate[:IMMediate]:SEQuence2  
INITiate[:IMMediate]:NAME TEST  
TEST:EXECute

## TRIG:SEQ2/ TRIG:TEST

Executes a software trigger for the SEQUENCE2 (TEST) group. This command is valid when TRIG:SEQ2:SOUR or TRIG:TEST:SOUR is set to BUS.

**Command** TRIGger:SEQuence2[:IMMediate]  
TRIGger:TEST[:IMMediate]

## TEST:ABOR

Aborts the SEQUENCE2 (TEST) group's test.

**Command** TEST:ABORt

## ABOR

Aborts the tests and measurements of all sequence groups. The TOS5200's trigger state immediately after it turns on is the same as its trigger state after it receives an ABOR command.

If you send an ABOR command while the TOS5200 is executing tests or measurements, the measured data is discarded.

If you send an ABOR command without first sending an INIT command and if the measurement data that is held in the TOS5200 is valid, the measured data is not discarded.

**Command** `ABORt`

## TEST:PROT:CLE

Clears the protection mode.

**Command** `TEST:PROTECTION:CLEAr`



# Querying Measured Values (SEquence1:ACQuire)

You can query the measured value while tests (SEQ2) are being performed.

## TRIG:COUN

\* RST

Sets the trigger count to apply to the SEquence1 (ACQuire) group.

Trigger count	Response when a measurement command is sent
1	Single measured value
2 to 100	Comma-separated list of all measured data points

**Command** TRIGger[:SEquence[1]]:COUNT {<numeric>|MIN|MAX}  
TRIGger[:SEquence[1]]:COUNT?  
TRIGger[:ACQuire]:COUNT {<numeric>|MIN|MAX}  
TRIGger[:ACQuire]:COUNT?

**Parameter** Value: 1 to 100 (The default value is 1.)

**Response** Returns the trigger count in <NR3> format.

## ABOR

Aborts the tests and measurements of all sequence groups. The TOS5200's trigger state immediately after it turns on is the same as its trigger state after it receives an ABOR command.

If you send an ABOR command while the TOS5200 is executing tests or measurements, the measured data is discarded.

If you send an ABOR command without first sending an INIT command and if the measurement data that is held in the TOS5200 is valid, the measured data is not discarded.

**Command** ABORt

## MEAS:CURR/ READ:CURR

Starts a new measurement and queries the current.

**Command** MEASure[:ARRay]:CURRent?  
READ[:ARRay]:CURRent?

**Response** Returns the measured current in <NR3> format or the measured currents as a comma-separated list in <NR3>,<NR3>,... format.

Unit: A

## MEAS:VOLT/ READ:VOLT

Starts a new measurement and queries the voltage.

**Command** MEASure [:ARRay] :VOLTage?  
READ [:ARRay] :VOLTage?

**Response** Returns the measured voltage in <NR3> format or the measured voltages as a comma-separated list in <NR3>,<NR3>,... format.

Unit: V

## MEAS:TIME/ READ:TIME

Starts a new measurement and queries the elapsed test time.

**Command** MEASure [:ARRay] :TIME?  
READ [:ARRay] :TIME?

**Response** Returns the elapsed test time in <NR3> format or the measured elapsed times as a comma-separated list in <NR3>,<NR3>,... format.

Unit: s

## TRIG:SOUR

\* RST

Sets the trigger source to apply to the SEquence1 (ACQuire) group.

**Command** TRIGger [:SEquence [1]] :SOURce {IMMediate|BUS|TIMer|TEST}  
TRIGger [:SEquence [1]] :SOURce?  
TRIGger [:ACQuire] :SOURce {IMMediate|BUS|TIMer|TEST}  
TRIGger [:ACQuire] :SOURce?

Parameter	Value:	IMMediate	Begin measuring immediately (default).
		BUS	Wait for a software trigger—a *TRG, TRIG, or IEEE 488.1 get (Group Execute Trigger) command—and then begin measuring.
		TIMer	Begin measuring when the time set with TRIG:TIM elapses.
		TEST	Begin measuring when a test begins.

**Response** Returns the trigger source in <character> format.

## TRIG:TIM

\* RCL

Sets the trigger timer to apply to the SEquence1 (ACQuire) group. This command is enabled when the trigger source is set to TIM.

**Command** TRIGger [:SEquence [1]] :TIMer {<numeric>|MIN|MAX}  
TRIGger [:SEquence [1]] :TIMer? {MIN|MAX}  
TRIGger [:ACQuire] :TIMer {<numeric>|MIN|MAX}  
TRIGger [:ACQuire] :TIMer? {MIN|MAX}

Parameter Value: 0 to 60.0 (The default value is 0.)  
Unit: s

**Response** Returns the trigger timer's set time in <NR3> format.

## INIT:SEQ1/ INIT:NAME ACQ

Begins a new measurement (starts the trigger function).  
Measurement is started by the trigger source set with TRIG:SOUR.

**Command** `INITiate[:IMMEDIATE]:SEquence1`  
`INITiate[:IMMEDIATE]:NAME ACQuire`

## TRIG

Executes a software trigger for the SEquence1 (ACQuire) group.

**Command** `TRIGger[:SEquence[1]][:IMMEDIATE]`  
`TRIGger[:ACQuire][:IMMEDIATE]`

## FETC:CURR

Queries the measured current without starting a new measurement.

**Command** `FETCh[:ARRAY]:CURRent?`

**Response** Returns the measured current in <NR3> format or the measured currents as a comma-separated list in <NR3>,<NR3>,... format.  
Unit: A

## FETC:VOLT

Queries the measured voltage without starting a new measurement.

**Command** `FETCh[:ARRAY]:VOLTage?`

**Response** Returns the measured voltage in <NR3> format or the measured voltages as a comma-separated list in <NR3>,<NR3>,... format.  
Unit: V

## FETC:TIME

Queries the measured elapsed test time without starting a new measurement.

**Command** `FETCh[:ARRAY]:TIME?`

**Response** Returns the measured elapsed test time in <NR3> format or the measured elapsed times as a comma-separated list in <NR3>,<NR3>,... format.  
Unit: s

## RES

Queries the results of the previous test.

**Command** `RESult[:IMmediate]?`

**Response** Returns the following results of the previous test: test number, program number, test mode, test start ti

**Response** me, voltage, current, resistance, test time, and judgment result. Each result is separated by a comma in the following format: <NR1>, <NR1>,<character>, <NR1>, <NR3>, <NR3>, <NR3>, <NR3>, <character>.

Response format <NR1>Test number

A counter that is incremented each time a test is executed. After **4294967295**, the count returns to **0**.

<NR1>Program number

Always returns 1.

<Character>Test mode **ACW** (AC withstanding voltage test)

Always returns **ACW**.

<NR1>Test start time

Because there is no function for measuring the test start time, a bar is returned.

<NR3>Voltage

Measured voltage

<NR3>Current

Measured current

If the test result is **FAIL**, the judgment criterion is returned.

<NR3>Resistance

Because there is no function for measuring the resistance, **0.00000 E+00?** is returned.

<NR3>Test time

The test time is returned.

<Character>Judgment result {PASS|U-FAIL|L-FAIL|PROT|ABORT}

**PASS:** The test was successful.

**U-FAIL:** A value exceeding the upper limit was detected.

**L-FAIL:** A value less than the lower limit was detected.

**PROT:** A protection function was activated, and the test was stopped.

**ABORT:** Test was aborted.

# Various Settings

## PASS judgment result hold time setting

### SYST:CONF:PHOL

\* RST

Sets the length of time that a PASS judgment result will be held (Pass Hold).

**Command** `SYSTem:CONFIgure:PHOLd {<numeric>|MIN|MAX|INFIinity}`  
`SYSTem:CONFIgure:PHOLd? {MIN|MAX}`

**Parameter** Value: 50 m, 100 m, 200 m, 1, 2, 5 (The default value is 50 m.)  
INFIinity The PASS judgment result is held indefinitely (HOLD).

**Response** Returns the length of time that a PASS judgment result will be held in <NR3> format.  
Unit: s

## Buzzer volume settings

### SYST:CONF:BEEP:VOL:FAIL

\* RST

Sets the volume level of the buzzer that is sounded when a FAIL judgment occurs.

**Command** `SYSTem:CONFIgure:BEEPer:VOLume:FAIL {<numeric>|MIN|MAX}`  
`SYSTem:CONFIgure:BEEPer:VOLume:FAIL? {MIN|MAX}`

**Parameter** Value: 0.0 to 0.9 (The default value is 0.5.)

**Response** Returns the volume level of the buzzer that is sounded when a FAIL judgment occurs in <NR3> format.

### SYST:CONF:BEEP:VOL:PASS

\* RST

Sets the volume level of the buzzer that is sounded when a PASS judgment occurs.

**Command** `SYSTem:CONFIgure:BEEPer:VOLume:PASS {<numeric>|MIN|MAX}`  
`SYSTem:CONFIgure:BEEPer:VOLume:PASS? {MIN|MAX}`

**Parameter** Value: 0.0 to 0.9 (The default value is 0.3.)

**Response** Returns the volume level of the buzzer that is sounded when a PASS judgment occurs in <NR3> format.

## Other settings

### SYST:ERR

Queries the oldest error or event from the error/event queue. The error/event queue can hold up to 255 errors.

The error/event queue is cleared if a \*CLS command is sent.

**Command** `SYSTem:ERRor[:NEXT]?`

**Response** Returns the oldest error or event from the error/event queue in the following format.

Example If the queue is empty

This command returns 0 "No error."

Example If a command has been received that cannot be executed in the present operating state of the TOS5200

This command returns -221, "Settings conflict."

If there are multiple errors in the queue, the errors are returned from the oldest error first. Errors are cleared from the queue after they have been returned.

### SYST:KLOC

Locks or releases panel operations (key lock). When keys are locked, only the START and STOP switches are enabled.

**Command** `SYSTem:KLOCK {ON|OFF|1|0}`  
`SYSTem:KLOCK?`

Parameter	Value:	ON (1)	Panel operations are locked.
		OFF (0)	Locked panel operations are released (default).

**Response** Returns the key lock status in <NR1> format.

### SYST:LOC

Switches the TOS5200 to local mode (panel operation). This is a substitute command for the IEEE 488.1 REN message (Remote Disable).

You can switch the TOS5200 back to remote mode by sending the SYST:REM or SYST:RWL command.

**Command** `SYSTem:LOCa1`

## SYST:OPT

Queries the options that are installed in the TOS5200. This command performs the same function as the \*OPT? command.

**Command** `SYSTem:OPTion?`

**Response** Returns "0" if no options are installed. Returns one of the following responses in <character> format if options are installed.

Returns "RC0X-TOS" if an RC01-TOS, RC02-TOS, HP01A-TOS, or HP02A-TOS option is installed. Returns "SIGNAL I/O" if a SIGNAL I/O option is installed.

**Example** If the RC01-TOS is installed

This command returns "RC0X-TOS."

## SYST:REM

Switches the TOS5200 to remote mode. All panel operations, except those of the LOCAL key and the STOP switch, are locked. This is a substitute command for the IEEE 488.1 REN message (Remote Enable). This is also the substitute command for address specification.

You can switch the TOS5200 back to local mode by sending the SYST:LOC command.

**Command** `SYSTem:REMOte`

## SYST:RWL

Switches the TOS5200 to remote mode. Except for the STOP switch, all panel operations (including those of the LOCAL key) are locked. This is a substitute command for the IEEE 488.1 REN (Remote Enable), address specification, and llo (Local Lock Out) messages.

You can switch the TOS5200 back to local mode by sending the SYST:LOC command. If you send the SYST:REM command, you can use the LOCAL key.

**Command** `SYSTem:RWLock`

## SYST:VERS

Queries the version of the SCPI specifications that the TOS5200 complies with.

**Command** `SYSTem:VERSion?`

**Response** Always returns 1999.0.

# Status Register and Status Report Function

IEEE 488.2 and SCPI registers are used for status reports.

In each SCPI status register, there are the following sub registers: the CONDition register, the EVENT register, the ENABLE register, the PTRansition filter, and the NTRansition filter.

## CONDition register

The CONDition register transmits automatically and reflects the condition of the TOS5200 in real time. Reading this register does not affect its contents.

## EVENT register

The EVENT register bits are automatically set according to the changes in the CONDition register. The rule for setting the bits varies depending on the positive and negative transition filters (PTRansition and NTRansition). The EVENT register is reset when it is read.

## ENABLE register

The ENABLE register enables reports to the summary bit or status bit of the event bits.

## Transition filters

Use the PTRansition (positive transition) filter to report events when the condition changes from false to true.

Use the NTRansition (negative transition) filter to report events when the condition changes from true to false.

If both the positive filter and negative filter are set to true, events can be reported each time the status changes.

If both filters are cleared, event reporting is disabled.



Structure of SCPI status registers

1999 SCPI Syntax & Style

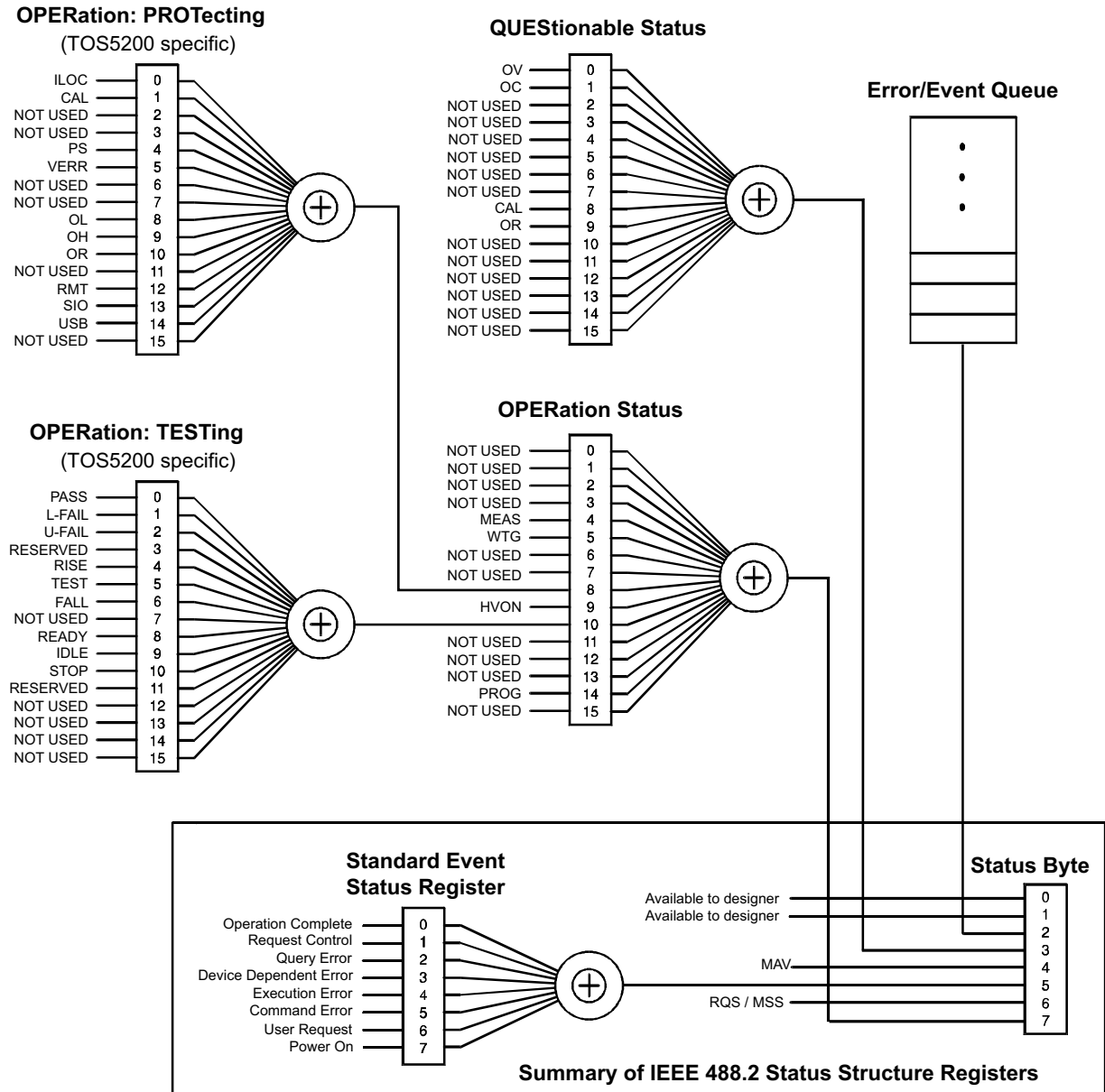

Partially changed SCPI Standard 1999.0 Volume 1 fig. 9-1

# IEEE 488.2 Register Model

## Status byte register

The status byte register stores STB and RQS (MSS) messages as defined by the IEEE 488.1 standard. The status byte register can be read by using IEEE 488.1 serial polling or the IEEE 488.2 common command \*STB?.

When the controller executes serial polling, bit 6 responds with request service (RQS). The status byte value is not changed by serial polling.

\*STB? makes the TOS5200 transmit the contents of the status byte register and the master status summary (MSS) message.

\*STB? does not change the status byte, MSS, and RQS.

Bit	Bit weight	Bit name	Description
0	1	Reserved	Reserved for future use by IEEE 488. The bit value is notified as zero.
1	2	Reserved	
2	4	Error/Event Queue (EEQ)	If data exists in the error/event queue, this bit is set to true.
3	8	Questionable Status Register (QUES)	This bit is set to true when a bit is set in the QUESTIONABLE event status register and the corresponding bit in the QUESTIONABLE status enable register is true.
4	16	Message Available (MAV)	This bit is set to true when a request is received from the digital programming interface and the TOS5200 is ready to generate the data byte.
5	32	Standard Event Status Bit Summary (ESB)	This bit is set to true when a bit is set in the event status register.
6	64	Request Service (RQS)	This bit is set to true when a bit is set in the service request enable register and the corresponding bit exists in the status byte. The SRQ line of the USB is set.
		Master Status Summary (MSS)	This bit is set to true when any bit in the status byte register is set to 1 and the corresponding bit in the service request enable register is set to 1.
7	128	Operation Status Register (OPER)	This bit is set to true when a bit is set in the OPERATION event status register and the corresponding bit in the OPERATION status enable register is set.
8-15	—	NOT USED	—

## Event status register (standard event status register)

The event status register bits are set when certain events occur during TOS5200 operation. All the event status register bits are set by the error/event queue.

This register is defined by the IEEE 488.2 standard and is controlled by the IEEE 488.2 common commands \*ESE, \*ESE?, and \*ESR?.

Bit	Bit weight	Bit name	Description
0	1	Operation Complete (OPC)	Set when an *OPC command is received and all operations in standby have been completed.
1	2	Request Control (RQC)	—
2	4	Query Error (QYE)	Set when an attempt is made to read data from the output queue when there is no data or when the output queue is not in the wait state. This indicates that there is no data in the output queue.
3	8	Device Dependent Error (DDE)	Set when there is a device-specific error.
4	16	Execution Error (EXE)	Set when the TOS5200 evaluates that the program data after the header is outside the formal input range or does not match the specifications of the TOS5200. This indicates that a valid SCPI command may not be executed correctly depending on the state of the TOS5200.
5	32	Command Error (CME)	Set when an IEEE 488.2 syntax error is detected by the parser, when an unidentifiable header is received, or when a group execution trigger enters the internal IEEE 488.2 SCPI command input buffer.
6	64	User Request (URQ)	—
7	128	Power ON (PON)	Set when the power is turned on.
8-15	—	Reserved	—

# SCPI Register Model

## OPERation status register (STATus:OPERation)

The OPERation status register is a 16-bit register that contains information about the normal operating conditions of the TOS5200.

Bit	Bit weight	Bit name	Description
0	1	NOT USED	—
1	2	NOT USED	—
2	4	NOT USED	—
3	8	NOT USED	—
4	16	MEASuring (MEAS)	Measurements are being performed (SEQ1)
5	32	Waiting for TRIGger (WTG)	Waiting for triggers
6	64	NOT USED	—
7	128	NOT USED	—
8	256	RROTECTing (PROT)	This bit is set to true when a bit is set in the PROTECTing status register.
9	512	High Voltage ON (HVON)	During testing or while voltage remains across the output terminals
10	1024	TESTing (TEST)	This bit is set to true when a bit is set in the TESTing status register.
11	2048	NOT USED	—
12	4096	NOT USED	—
13	8192	NOT USED	—
14	16384	PROGram is running (PROG)	During test execution (SEQ2)
15	32768	NOT USED	—

### STAT:OPER

Queries the event of the OPERation status register.

A query clears the contents of the register.

**Command** STATus:OPERation[:EVENT]?

**Response** Returns the event of the OPERation status register in <NR1> format.

### STAT:OPER:COND

Queries the condition of the OPERation status register.

A query does not clear the contents of the register.

**Command** STATus:OPERation:CONDition?

**Response** Returns the condition of the OPERation status register in <NR1> format.

## STAT:OPER:ENAB

Sets the enable register of the OPERation status register.

**Command** `STATus:OPERation:ENABle <NRf>`  
`STATus:OPERation:ENABle?`

Parameter Value: 0 to 65535

**Response** Returns the enable register of the OPERation status register in <NR1> format.

## STAT:OPER:NTR

Sets the negative transition filter of the OPERation status register.

**Command** `STATus:OPERation:NTRansition <NRf>`  
`STATus:OPERation:NTRansition?`

Parameter Value: 0 to 65535

**Response** Returns the negative transition filter of the OPERation status register in <NR1> format.

## STAT:OPER:PTR

Sets the positive transition filter of the OPERation status register.

**Command** `STATus:OPERation:PTRansition <NRf>`  
`STATus:OPERation:PTRansition?`

Parameter Value: 0 to 65535

**Response** Returns the positive transition filter of the OPERation status register in <NR1> format.

## PROtecting status register (STATus:OPERation:PROtecting)

The PROtecting status register is a 16-bit register that contains information about the status of the TOS5200 protection functions. This status register is unique to the TOS5200.

Bit	Bit weight	Bit name	Description
0	1	Interlock (ILOCK)	Interlock signal input detected.
1	2	Calibration (CAL)	The set calibration date has passed.
2	4	NOT USED	—
3	8	NOT USED	—
4	16	Power Supply (PS)	Power supply problem detected.
5	32	Volt Error (VERR)	The output voltage exceeded the rated limits.
6	64	NOT USED	—
7	128	NOT USED	—
8	256	Over Load (OL)	The output power exceeded the output limit.
9	512	Over Heat (OH)	The internal temperature of the TOS5200 has become abnormally high.
10	1024	Over Rating (OR)	An output current was generated for a length of time that exceeds the rated time.
11	2048	NOT USED	—
12	4096	Remote (RMT)	A connection or disconnection of the remote control connector was detected.
13	8192	SIGNAL I/O (SIO)	A change in the SIGNAL I/O connector's ENABLE signal was detected.
14	16384	USB	A connection or disconnection of the USB cable while the TOS5200 was being controlled remotely was detected.
15	32768	NOT USED	—

### STAT:OPER:PROT

Queries the event of the PROtecting status register.  
A query clears the contents of the register.

**Command** STATus:OPERation:PROtecting[:EVENT]?

**Response** Returns the event of the PROtecting status register in <NR1> format.

### STAT:OPER:PROT:COND

Queries the condition of the PROtecting status register.  
A query does not clear the contents of the register.

**Command** STATus:OPERation:PROtecting:CONDtion?

**Response** Returns the condition of the PROtecting status register in <NR1> format.

## STAT:OPER:PROT:ENAB

Sets the enable register of the PROTECTing status register.

**Command** `STATus:OPERation:PROTECTing:ENABle <NRf>`  
`STATus:OPERation:PROTECTing:ENABle?`

Parameter Value: 0 to 65535

**Response** Returns the enable register of the PROTECTing status register in <NR1> format.

## STAT:OPER:PROT:NTR

Sets the negative transition filter of the PROTECTing status register.

**Command** `STATus:OPERation:PROTECTing:NTRansition <NRf>`  
`STATus:OPERation:PROTECTing:NTRansition?`

Parameter Value: 0 to 65535

**Response** Returns the negative transition filter of the PROTECTing status register in <NR1> format.

## STAT:OPER:PROT:PTR

Sets the positive transition filter of the PROTECTing status register.

**Command** `STATus:OPERation:PROTECTing:PTRansition <NRf>`  
`STATus:OPERation:PROTECTing:PTRansition?`

Parameter Value: 0 to 65535

**Response** Returns the positive transition filter of the PROTECTing status register in <NR1> format.

## TESTing status register (STATus:OPERation:TESTing)

The TESTing status register is a 16-bit register that contains information about the status of tests on the TOS5200. This status register is unique to the TOS5200.

Bit	Bit weight	Bit name	Description
0	1	PASS	PASS judgment
1	2	L-FAIL	L-FAIL judgment
2	4	U-FAIL	U-FAIL judgment
3	8	RESERVED	—
4	16	RISE	Voltage rising
5	32	TEST	Testing
6	64	FALL	Voltage falling
7	128	NOT USED	—
8	256	READY	Waiting for testing to start
9	512	IDLE	Standby
10	1024	STOP	Stopping testing
11	2048	RESERVED	—
12	4096	NOT USED	—
13	8192	NOT USED	—
14	16384	NOT USED	—
15	32768	NOT USED	—

### STAT:OPER:TEST

Queries the event of the TESTing status register.  
A query clears the contents of the register.

**Command** `STATus:OPERation:TESTing[:EVENT]?`

**Response** Returns the event of the TESTing status register in <NR1> format.

### STAT:OPER:TEST:COND

Queries the condition of the TESTing status register.  
A query does not clear the contents of the register.

**Command** `STATus:OPERation:TESTing:CONDtion?`

**Response** Returns the condition of the TESTing status register in <NR1> format.



## STAT:OPER:TEST:ENAB

Sets the enable register of the TESTING status register.

**Command** `STATus:OPERation:TESTing:ENABle <NRf>`  
`STATus:OPERation:TESTing:ENABle?`

Parameter Value: 0 to 65535

**Response** Returns the enable register of the TESTING status register in <NR1> format.

## STAT:OPER:TEST:NTR

Sets the negative transition filter of the TESTING status register.

**Command** `STATus:OPERation:TESTing:NTRansition <NRf>`  
`STATus:OPERation:TESTing:NTRansition?`

Parameter Value: 0 to 65535

**Response** Returns the negative transition filter of the TESTING status register in <NR1> format.

## STAT:OPER:TEST:PTR

Sets the positive transition filter of the TESTING status register.

**Command** `STATus:OPERation:TESTing:PTRansition <NRf>`  
`STATus:OPERation:TESTing:PTRansition?`

Parameter Value: 0 to 65535

**Response** Returns the positive transition filter of the TESTING status register in <NR1> format.

## QUEStionable status register (STATus:QUEStionable)

The QUEStionable status register is a 16-bit register that stores information related to the TOS5200's status and the questionable events that occur during TOS5200 operation.

These register bits may indicate that there are problems with the TOS5200's measured data.

Bit	Bit weight	Bit name	Description
0	1	Over Voltage (OV)	A voltage outside of the voltage measurement range was detected.
1	2	Over Current (OC)	A current outside of the current measurement range was detected.
2	4	NOT USED	—
3	8	NOT USED	—
4	16	NOT USED	—
5	32	NOT USED	—
6	64	NOT USED	—
7	128	NOT USED	—
8	256	CALibration (CAL)	The calibration date has passed.
9	512	Over Resistance (OR)	A resistance outside of the resistance measurement range was detected.
10	1024	NOT USED	—
11	2048	NOT USED	—
12	4096	NOT USED	—
13	8192	NOT USED	—
14	16384	NOT USED	—
15	32768	NOT USED	—

### STAT:QUES

Queries the event of the QUEStionable status register.

A query clears the contents of the register.

**Command** `STATus:QUEStionable[:EVENT]?`

**Response** Returns the event of the QUEStionable status register in <NR1> format.

### STAT:QUES:COND

Queries the condition of the QUEStionable status register.

A query does not clear the contents of the register.

**Command** `STATus:QUEStionable:CONDition?`

**Response** Returns the condition of the QUEStionable status register in <NR1> format.

## STAT:QUES:ENAB

Sets the enable register of the QUEStionable status register.

**Command** `STATus:QUEStionable:ENABle <NRf>`  
`STATus:QUEStionable:ENABle?`

Parameter Value: 0 to 65535

**Response** Returns the enable register of the QUEStionable status register in <NR1> format.

## STAT:QUES:NTR

Sets the negative transition filter of the QUEStionable status register.

**Command** `STATus:QUEStionable:NTRansition <NRf>`  
`STATus:QUEStionable:NTRansition?`

Parameter Value: 0 to 65535

**Response** Returns the negative transition filter of the QUEStionable status register in <NR1> format.

## STAT:QUES:PTR

Sets the positive transition filter of the QUEStionable status register.

**Command** `STATus:QUEStionable:PTRansition <NRf>`  
`STATus:QUEStionable:PTRansition?`

Parameter Value: 0 to 65535

**Response** Returns the positive transition filter of the QUEStionable status register in <NR1> format.

## Preset status

---

### STAT:PRES

Resets the ENABle register and the transition filters (PTRansition and NTRansition) of all status registers (including sub registers) to their default values.

Default values:

`STATus:ENABle = 0x0000`

`STATus:PTRansition = 0x7FFF`

`STATus:NTRansition = 0x0000`

**Command** `STATus:PRESet`

# TOS5050A Commands

The TOS5200 can use Kikusui TOS5050A commands.

Programs created with TOS5050A commands can be used without any modifications, but when you create new programs, we recommend that you use SCPI commands.

SCPI commands that behave in the same manner as TOS5050A commands are indicated. They are not fully compatible, so you need to be careful when you create programs.

For details, see the explanation of SCPI commands.

## STAT

Queries the TOS5200 status.

**Command** `STATus?`

**Response** The TOS5200 status is returned.

PROTECTION	A protection function was activated, and the test was stopped.
TEST	Testing
READY	Waiting for testing to start
PASS	The test was successful.
U FAIL	A value exceeding the upper limit was detected.
L FAIL	A value less than the lower limit was detected.
ELSE	None of the above

### ■ SCPI Command

 p. 46 , p. 48

`STATus:OPERation:PROTecting:CONDtion?`  
`STATus:OPERation:TESTing:CONDtion?`

## MODE

Queries the timer setting, lower limit setting, and test mode setting.

**Command** `MODE?`

**Response** Returns the timer setting, lower limit setting, and test mode setting in comma-separated format.

Example When the timer setting is on, lower limit setting is on, and test mode is AC  
`TIMER ON, LOWER ON, VOLT AC` is returned.

Example When the timer setting is off, lower limit setting is off, and test mode is DC  
`TIMER OFF, LOWER OFF, VOLT DC` is returned.

### ■ SCPI Command

 p. 24 , p. 26 ,  
p. 27

`SOURCE[:ACW]:VOLTage:TIMer? {MIN|MAX}`  
`SOURCE[:ACW]:VOLTage:TIMer:STATe?`  
`SENSE[:ACW]:JUDGment:LOWer? {MIN|MAX}`  
`SENSE[:ACW]:JUDGment:LOWer:STATe?`  
`SOURCE:FUNCTion:MODE?`

## MEAS

Queries the TOS5200 measured value.

**Command** `MEASure?`

**Response** Returns the TOS5200 measured value. The returned value varies depending on whether a test is in progress.

When a test is in progress

The measured voltage, measured current, and elapsed test time are returned.

When a test is not in progress

The previous test results are returned.

The maximum measured voltage, maximum measured current, elapsed test time, and status are returned.

Status: PROTECT A protection function was activated, and the test was stopped.

PASS The test was successful.

U FAIL A value exceeding the upper limit was detected.

L FAIL A value less than the lower limit was detected.

STOP The test was stopped.

P ON After the power was first turned on (no tests have been executed).

### ■ SCPI Command

 p. 33 , p. 34 ,  
p. 36

`MEASure[:ARRAY]:CURRENT?`

`MEASure[:ARRAY]:VOLTage?`

`MEASure[:ARRAY]:TIME?`

`RESult[:IMMEDIATE]?`

## TMOD

\* RST

 p. 11

Sets the talk mode.

**Command** `TMODE {0|1}`  
`TMODE?`

Parameter	Value:	0	Talk mode 0 (default)
		1	Talk mode 1

**Response** When the talk mode is sent, OK is returned.  
When a talk mode query is sent, the present talk mode is returned.

**Example** When set to talk mode 1

`TMODE1` is returned.

## REMOTE

Switches the TOS5200 to remote mode.  
“RMT” is displayed on the screen.

**Command** `REMOTE`

**Response** OK is returned.



The mode returns to LOCAL when the TOS5200 is restarted.

### ■ SCPI Command

p. 39

`SYSTEM:REMOte`  
`SYSTEM:RWLock`

## LOCAL

Switches the TOS5200 to local mode (panel operation).  
“RMT” disappears from the screen.

**Command** `LOCAL`

**Response** OK is returned.

### ■ SCPI Command

p. 38

`SYSTEM:LOCa1`

## START

Start a test.

**Command** `START`

**Response** When the START command is enabled.  
OK is returned.

When the START command is disabled.  
ERROR is returned.



- The START command is enabled when the TOS5200 is in REMOTE mode from RS232C (REMOTE command has been sent).
- If the double action feature or momentary feature is set to ON, tests do not start even when you send a START command.  
In the panel CONFIG settings, set the double action feature or momentary feature to OFF.

### ■ SCPI Command

p. 31

`TEST:EXECute`

## STOP

The test will be suspended.

**Command** STOP

**Response** OK is returned.

### NOTE

To clear PROTECTION mode, fix the problem that caused it, and then send the STOP command, or press STOP on the front panel.

 p. 31

### ■ SCPI Command

**TEST:ABORT**

## Performing tests

We will use an AC withstanding voltage test (ACW) to explain how to perform single operations.

Set the test conditions (test voltage, limit voltage, upper and lower limits, and test time):

```
SOUR:VOLT 1.5KV
SOUR:VOLT:PROT 2KV
SENS:JUDG 10MA
SENS:JUDG:LOW 0.01MA
SENS:JUDG:LOW:STAT ON
SOUR:VOLT:TIM 60S
SOUR:VOLT:TIM:STAT ON
```

Set additional test conditions (start voltage, voltage rise time, voltage fall time, and test voltage frequency):

```
SOUR:VOLT:STAR:STAT ON
SOUR:VOLT:SWE:TIM 5S
SOUR:VOLT:SWE:FALL:TIM:STAT OFF
SOUR:VOLT:FREQ 60HZ
```

After setting the test conditions, start the test (in this example, we will just start the test without using any triggers).

When you send the INIT command, the test starts.

You cannot start the test if memory is being recalled or saved, the TOS5200 is in protection mode, or PASS/FAIL judgment is being performed.

```
TRIG:TEST:SOUR IMM
TEST:EXEC
```

You can query the voltage and current values during testing:

```
MEAS:CURR?
MEAS:VOLT?
```

The test stops when the test time elapses (a PASS judgment), if a FAIL judgment occurs, or if the STOP switch is pressed. You can also end the test by sending the ABOR command, but the test results will be discarded. When the test finishes, you can query the test results (the overall judgment).

The condition of the OPER:TEST register is returned in NR1 format:

```
STAT:OPER:TEST:COND?
```





# Appendix

---

- A List of Messages
- B List of Errors
- C Default State
- D Command Processing Time
- E Using Visual Basic 2008

# A List of Messages

SCPI command: Command name in the short form.

Effect: "A" for commands that are affected by the \*RST and \*RCL commands. "B" for commands that are affected by the \*RST command.

R/W: "R" for query commands and "W" for set commands.

Nt: "1" for SCPI standard commands, "2" for commands that are being reviewed, and "3" for original commands developed by Kikusui Electronics Corporation.

## FETC/ MEASure/ READ subsystem

SCPI command		Value		Default	Response	Effect	Description	R/W	Nt
Program header	Parameter		Unit						
FETC[:ARR]									
	:CURR		A		NR3		Queries the measured current	R	3
	:VOLT		V		NR3		Queries the measured voltage	R	3
	:TIME		s		NR3		Queries the measured elapsed test time	R	3
MEAS[:ARR]   READ[:ARR]									
	:CURR		A		NR3		Starts a new measurement and queries the current	R	3
	:VOLT		V		NR3		Starts a new measurement and queries the voltage	R	3
	:TIME		s		NR3		Starts a new measurement and queries the elapsed test time	R	3

## INITiate/ TRIGger subsystem

SCPI command		Value		Default	Response	Effect	Description	R/W	Nt	
Program header	Parameter		Unit							
INIT[:IMM]										
	:NAME ACQ						Starts testing (starts the trigger function; SEQ1)	W	3	
	:NAME TEST						Starts testing (starts the trigger function; SEQ2)	W	3	
	:SEQ1						Starts testing (starts the trigger function; SEQ1)	W	3	
	:SEQ2						Starts testing (starts the trigger function; SEQ2)	W	3	
TRIG[:SEQ[1]]   TRIG[:ACQ] (sequence 1, ACQUIRE)										
	[:IMM]						Executes a software trigger (SEQ1)	W	1	
	:COUN	numeric	1 to 100	1	NR3	B	Executes a test with the applicable trigger count (SEQ1)	R/W	3	
	:SOUR	char	IMM   BUS   TIM   TEST	IMM	char	B	Sets the trigger source (SEQ1)	R/W	3	
	:TIM	numeric	0 to 60.0	S	0	NR3	B	Sets the trigger timer (SEQ1)	R/W	3
TRIG:SEQ2   TRIG:TEST (sequence 2, TEST)										
	[:IMM]						Executes a software trigger (SEQ2)	W	1	
	:SOUR	char	IMM   BUS   EXT	IMM	char	B	Sets the trigger source (SEQ2)	R/W	3	
	ABOR						Aborts testing or measurements	W	1	

## RES subsystem

SCPI command		Value		Default	Response	Effect	Description	R/W	Nt
Program header	Parameter		Unit						
RES[:IMM]					NR1, NR1, char, NR1, NR3, NR3, NR3, NR3, char		Queries the results of the previous test in the following order: test number, program number, test mode, test start time, measured voltage, measured current, measured resistance, test time, and judgment result.	R	3

## SENSe subsystem

SCPI command		Value		Default	Response	Effect	Description	R/W	Nt
Program header	Parameter		Unit						
SENS									
[:ACW]									
	:JUDG[:UPP]	numeric	0.01 m to 110 m	A	0.02 m	NR3	A	Sets the upper limit	R/W 3
	:JUDG:LOW	numeric	0.01 m to 110 m	A	0.01 m	NR3	A	Sets the lower limit	R/W 3
	:STAT	bool			OFF	NR1	A	Turns the lower limit on and off	R/W 3
	:MODE	char	RMS   AVE		RMS	char	B	Sets the measurement mode	R/W 3

## SOURce subsystem

SCPI command		Value		Default	Response	Effect	Description	R/W	Nt
Program header	Parameter		Unit						
SOUR									
	:FUNC:MODE	char	ACW   DCW   IR		ACW	char	A	Sets the test mode	R/W 3
[:ACW]:VOLT									
	:FREQ	numeric	50   60	HZ	50	NR3	A	Sets the test voltage frequency	R/W 3
	[:LEV]	numeric	0 to 5.5 k	V	0	NR3	A	Sets the test voltage	R/W 3
	:PROT[:LEV][:UPP]	numeric	0 to 5.5 k	V	5.5 k	NR3	A	Sets the limit voltage	R/W 3
	:STAR:STAT	bool			OFF	NR1	A	Turns the start voltage on and off	R/W 3
:SWE									
	:FALL:TIM:STAT	bool			OFF	NR1	A	Turns the voltage fall time on and off	R/W 3
	[:RISE]:TIM	numeric	0.1 to 10.0	S	0.1	NR3	A	Sets the voltage rise time	R/W 3
	:TIM	numeric	0.1 to 999.0	S	0.1	NR3	A	Sets the test time	R/W 3
	:STAT	bool			ON	NR1	A	Turns on or off the feature that ends tests when their test time elapses	R/W 3

## STATus subsystem

SCPI command		Value		Default	Response	Effect	Description	R/W	Nt
Program header	Parameter		Unit						
STAT									
:OPER									
	[:EVEN]				NR1		Queries events <sup>1</sup>	R	1
	:COND				NR1		Queries register status <sup>1</sup>	R	1
	:ENAB	NRf	0 to 65535		NR1		Enable <sup>1</sup>	R/W	1
	:NTR	NRf	0 to 65535		NR1		Negative transition <sup>1</sup>	R/W	1
:PROT									
	[:EVEN]				NR1		Queries events <sup>2</sup>	R	1
	:COND				NR1		Queries register status <sup>2</sup>	R	1
	:ENAB	NRf	0 to 65535		NR1		Enable <sup>2</sup>	R/W	1
	:NTR	NRf	0 to 65535		NR1		Negative transition <sup>2</sup>	R/W	1
	:PTR	NRf	0 to 65535		NR1		Positive transition <sup>2</sup>	R/W	1
	:PTR	NRf	0 to 65535		NR1		Positive transition <sup>1</sup>	R/W	1
:TEST									
	[:EVEN]				NR1		Queries events <sup>3</sup>	R	1
	:COND				NR1		Queries register status <sup>3</sup>	R	1
	:ENAB	NRf	0 to 65535		NR1		Enable <sup>3</sup>	R/W	1
	:NTR	NRf	0 to 65535		NR1		Negative transition <sup>3</sup>	R/W	1
	:PTR	NRf	0 to 65535		NR1		Positive transition <sup>3</sup>	R/W	1
	:PRES						Resets filter registers to default values	W	1
:QUES									
	[:EVEN]				NR1		Queries events <sup>4</sup>	R	1
	:COND				NR1		Queries register status <sup>4</sup>	R	1
	:ENAB	NRf	0 to 65535		NR1		Enable <sup>4</sup>	R/W	1
	:NTR	NRf	0 to 65535		NR1		Negative transition <sup>4</sup>	R/W	1
	:PTR	NRf	0 to 65535		NR1		Positive transition <sup>4</sup>	R/W	1

- 1 OPERation status register
- 2 PROTecting status register
- 3 TESTing status register
- 4 QUEStionable status register

## SYSTem subsystem

SCPI command		Value		Default	Response	Effect	Description	R/W	Nt	
Program header	Parameter		Unit							
SYST										
:CONF										
:BEEP:VOL										
	:FAIL	numeric	0.0 to 0.9		0.5	NR3	B	Sets the volume level of the buzzer that is sounded when a FAIL judgment occurs	R/W	3
	:PASS	numeric	0.0 to 0.9		0.3	NR3	B	Sets the volume level of the buzzer that is sounded when a PASS judgment occurs	R/W	3
	:PHOL	numeric	50 m   100 m   200 m   1   2   5   INF	S	50 m	NR3	B	Sets the PASS judgment result hold time	R/W	3
	:ERR[:NEXT]							Queries error and event information	R	1
	:KLOC	bool			OFF	NR1	B	Locks and unlocks panel operations	R/W	3
	:LOC							Switches to local mode	W	2
	:OPT					char		Queries options	R	3
	:REM							Switches to remote mode; locks all keys other than LOCAL and the STOP switch	W	2
	:RWL							Switches to remote mode; locks all keys other than the STOP switch	W	2
	:VERS					1999.0		Queries the version of the compliant SCPI specifications	R	1

App

## TEST subsystem

SCPI command		Value		Default	Response	Effect	Description	R/W	Nt	
Program header	Parameter		Unit							
TEST										
	:ABOR							Aborts testing (SEQ2)	W	3
	:EXEC							Starts testing (starts the trigger function; SEQ2)	W	3
	:PROT:CLE							Clears protection mode	W	3

## IEEE 488.2 common commands

IEEE488.2 common command	Parameter	Description	R/W
*CLS		Clears all the event registers	W
*ESE	NR1	Sets the event status enable register bits	R/W
*ESR		Queries the event status register	R
*IDN		Queries the identification string (manufacturer information)	R
*OPC		Causes the TOS5200 to generate the operation complete message in the event status register when all of its pending operations have finished	R/W
*OPT		Queries the options that are installed in the TOS5200.	R
*PSC	0   1	Sets whether the *ESE and *SRE settings will be cleared	R/W
*RCL	NR1	Loads the settings that have been stored to memory	W
*RST		Resets the TOS5200 Configures the TOS5200 to a known condition independent from the usage history of the device	W
*SAV	NR1	Saves the present settings to memory	W
*SRE	NR1	Sets the service request enable register	R/W
*STB		Queries the contents of the status byte register and the master summary status message	R
*TRG		Trigger command	W
*TST		Executes a self-test	R
*WAI		Prevents the TOS5200 from executing subsequent commands or queries until all operations that are in standby have completed	W

## TOS5050A commands

TOS5050A command	Parameter	Description	R/W
LOCAL		Disables the START command from RS232C	W
MEASURE		Queries the measured value	R
MODE		Queries the timer setting, lower limit setting, voltage mode setting and voltage range setting.	R
REMOTE		Enables the START command from RS232C	W
START		Starts a test	W
STATUS		Queries the TOS5200 status	R
STOP		Stops the test	W
TMOD	0   1	Sets the talk mode.	R/W

# B List of Errors

## Command errors

An error in the range [-199, -100] indicates that an IEEE 488.2 syntax error has been detected by the instrument's parser. The occurrence of any error in this class causes the Command Error bit (bit 5) in the event status register to be set.

Error code	Error message description	
-100	Command error	Generic syntax error.
-101	Invalid character	A syntactic element contains an invalid character.
-102	Syntax error	An unrecognized command or data type was encountered.
-103	Invalid separator	The parser was expecting a separator and encountered an illegal character.
-104	Data type error	The parser recognized a data element different than one allowed.
-105	GET not allowed	A Group Execute Trigger was received in a program message.
-108	Parameter not allowed	More parameters were received than expected for the header.
-109	Missing parameter	Fewer parameters were received than required for the header.
-110	Command header error	An error was detected in the header.
-120	Numeric data error	Generated when parsing a data element which appears to be numeric, including the nondecimal numeric types.
-130	Suffix error	Generated when parsing a suffix.
-131	Invalid suffix	The suffix does not follow the syntax, or the suffix is inappropriate for the TOS5200.
-134	Suffix too long	The suffix contained more than twelve characters.
-138	Suffix not allowed	A suffix was encountered after a numeric element that does not allow suffixes.
-140	Character data error	Generated when parsing a character data element.
-141	Invalid character data	Either the character data element contains an invalid character, or the element is not valid.
-144	Character data too Long	The character data element contains more than twelve characters.
-148	Character data not allowed	A legal character data element was encountered where prohibited by the TOS5200.
-150	String data error	Generated when parsing a string data element.
-160	Block data error	Generated when parsing a block data element.
-170	Expression error	Generated when parsing an expression data element.
-180	Macro error	Generated when defining a macro or executing a macro.

## Execution errors

An error in the range [-299, -200] indicates that an error has been detected by the instrument's execution control block. The occurrence of any error in this class causes the Execution Error bit (bit 4) in the event status register to be set.

Error code		Error message description
-200	Execution error (generic)	A generic TOS5200 error.
-203	Command protected	Password protected program or query command cannot be executed.
-210	Trigger error	A trigger error.
-211	Trigger ignored	A trigger was received but ignored.
-213	Init ignored	A measurement initiate operation was ignored because measurement is in progress.
-214	Trigger deadlock	A deadlock occurred because a query was received before the software trigger.
-220	Parameter error	A program data element related error occurred.
-221	Settings conflict	A command was received that the TOS5200 cannot execute in its present condition.
-222	Data out of range	Program value was outside the legal range.
-223	Too much data	Too many parameters were received for the requirements.
-224	Illegal parameter value	Received invalid parameter data.
-230	Data corrupt or stale	Received a data query before the measurement completed.
-241	Hardware missing	Cannot be executed because the optional hardware is not installed.

## Device-specific errors

Error code		Error message description
-330	Self-test failed	The self-test failed.
-360	Communication error	A communication error occurred.
-361	Parity error in program message	A parity bit was incorrect.
-362	Framing error in program message	The stop bit cannot be detected.
-363	Input buffer overrun	An overrun occurred in the input buffer.
-365	Time out error	A time out error occurred.



## Query errors

An error in the range [-499, -400] indicates that the output queue control of the instrument has detected a problem with the message exchange protocol described in IEEE 488.2, chapter 6. The occurrence of any error in this class causes the Query Error bit (bit 2) in the event status register to be set.

Error code		Error message description
-400	Query error (generic)	A generic TOS5200 error.
-410	Query INTERRUPTED	Received a new command before the response was read.
-420	Query UNTERMINATED	The controller attempted to read the response after the device received an unsupported query or has not received a query. The -100 "Command error" and this error are stored in the error/event queue. The controller will time out.
-430	Query DEADLOCKED	The error queue, input buffer, and output buffer are full when sending large binary data as a response, and the transmission timing is off.
-440	Query UNTERMINATED after indefinite response	Received a separate query in semicolon-delimited format after a query that returns a response in an indefinite form. Example: *IDN?;SYST:ERR?

## Operation complete event errors

An error in the range [-899, -800] is used when the TOS5200 wants to report an IEEE 488.2 operation complete event. This event occurs when the instrument's synchronization protocol, having been enabled by an \*OPC command, completes all selected pending operations.

The occurrence of this event causes the Operation Complete bit (bit 0) in the event status register to be set.

Error code		Error message description
-800	Operation complete	All selected pending operations in accordance with the IEEE 488.2, 12.5.2 synchronization protocol have completed.

App

# C Default State

When the TOS5200 is initialized at the factory or when it receives an \*RST or \*RCL command, its settings are set to the values shown in the following table.

When the power is turned on, the settings are set to the values that were in use immediately before the POWER switch was turned off.

Item		Command	Setting after initialization	Setting after command received	
				*RST	*RCL
Withstanding voltage test conditions (ACW)	Measurement mode	SENS:MODE	RMS	←	No effect
	Test voltage	SOUR:VOLT	0 V	←	Depends on the settings in memory
	Test voltage limit	SOUR:VOLT:PROT	5.5 kV		
	Start voltage on and off	SOUR:VOLT:STAR:STAT	OFF		
	Voltage rise time	SOUR:VOLT:SWE:TIM	0.1 s		
	Voltage fall time on and off	SOUR:VOLT:SWE:FALL:TIM:STAT	OFF		
	Upper limit	SENS:JUDG	0.02 mA		
	Lower limit	SENS:JUDG:LOW	0.01 mA		
	Lower limit on and off	SENS:JUDG:LOW:STAT	OFF		
	Test time	SOUR:VOLT:TIM	0.1 s		
	Test timer on and off	SOUR:VOLT:TIM:STAT	ON		
	Test voltage frequency	SOUR:VOLT:FREQ	50 Hz		
Test mode	AC withstanding voltage test	SOUR:FUNC:MODE	ACW		
Trigger source	(SEQ1)	TRIG:SOUR	IMM	←	No effect
	(SEQ2)	TRIG:SEQ2:SOUR/ TRIG:TEST:SOUR	IMM		
Trigger count (SEQ1)		TRIG:COUN	1		
Trigger timer (SEQ1)		TRIG:TIM	0	No change	0 (default value)
PASS judgment result hold time		SYST:CONF:PHOL	50	←	No effect
Buzzer volume	PASS judgment	SYST:CONF:BEEP:VOL:PASS	0.3	←	No change
	FAIL judgment	SYST:CONF:BEEP:VOL:FAIL	0.5		
Talk mode		TMOD	0	0 <sup>1</sup>	

1 Even when the talk mode is set to "0" with the \*RST command, it will return to the setting specified by the panel when the TOS5200 is restarted.

# D Command Processing Time

A certain amount of time is required before the commands shown in the following table are received by the TOS5200.

The processing times shown here are standard values, not guaranteed values. The processing times vary depending on the settings and the measurement conditions. The values shown below do not include hardware response times.

Command	USB processing time (ms)	Description
SOUR:VOLT 1KV	2	Sets the test voltage
SOUR:VOLT:TIM 1S	2	Sets the test time
SENS:JUDG 5MA	2	Sets the upper limit
MEAS:VOLT?	20	Starts a new measurement and queries the voltage
STAT:OPER:TEST:COND?	3	Queries register status

# E Using Visual Basic 2008

This appendix will explain how to use Visual Basic 2008 and the VISA library to communicate with the TOS5200 through its USB interface.

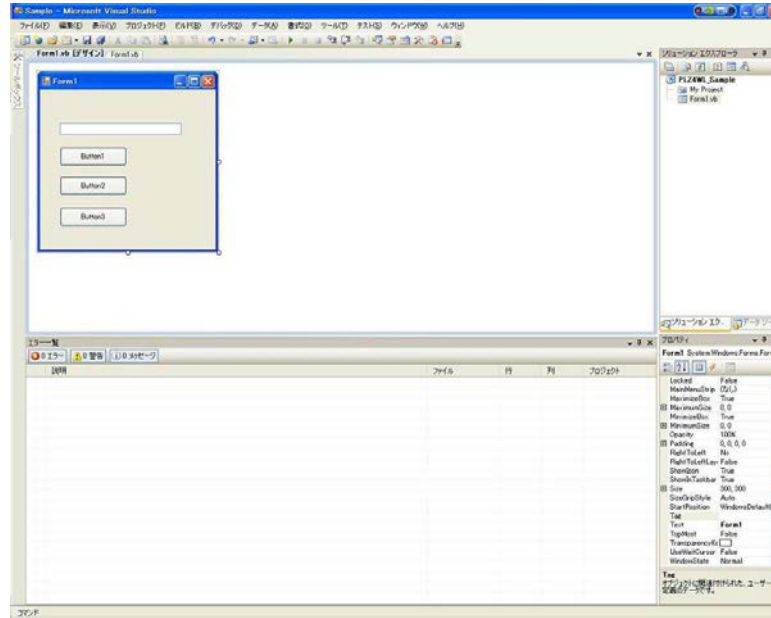

## Project settings

First, specify a driver for performing communications (the VISA library) in the project settings. On the Project menu, click Add Reference, and then click "VISA COM3.0 Type Library."

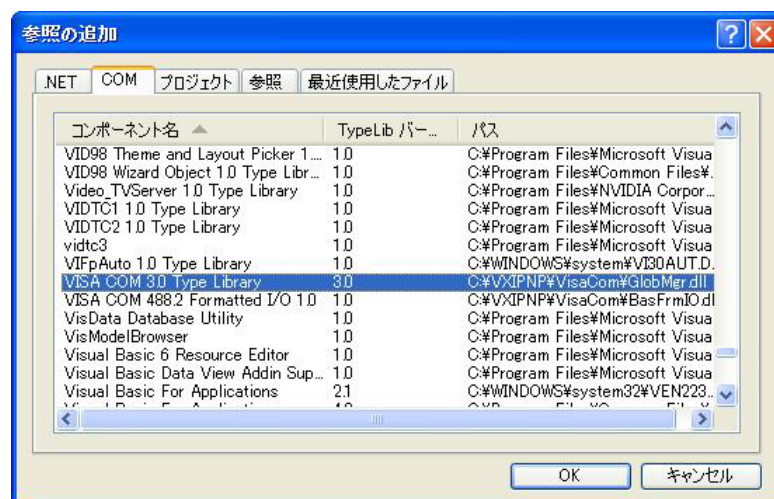

## Communicating through USB or RS232C

After you finish configuring the communication driver, you can perform communications through USB or RS232C.

We will explain the communication procedure that uses the VISA library.

## ■ Opening VISA

Before you can use the VISA library to communicate with the USB or RS232C feature, you have to open VISA. Specify an I/O resource to open VISA.

Example: Opening VISA to communicate over USB

```
Set rm = CreateObject("VISA.GlobalRM")
Set msg = rm.Open("USB::0x0B3E::0x1046::00000001::INSTR", NO_LOCK, 0, "")
```

"USB::0x0B3E::0x1046::00000001::INSTR" is an I/O resource.

The I/O resource syntax is shown below. The parts surrounded by square brackets ([ ]) can be omitted. Enter the appropriate values in the parts written in italics.

USB	USB[ <i>board</i> ]::VendorID::ProductID::SerialNumber[::InterfaceNumber][::INSTR] Example: A USBTMC measuring instrument whose vendor ID (VID) is 0x0B3E, product ID (PID) is 0x1046, and serial number is 00000001 USB0::0x0B3E::0x1046::00000001::INSTR
Serial (RS232C)	ASRL[ <i>board</i> ][::INSTR] Example: A measuring instrument connected to serial port COM1 ASRL1::INSTR

In VISA, you can use aliases for I/O resources.

If you use an alias for an I/O resource, even if the alias name is hard-coded in the application, the I/O resource name can still be changed to an appropriate value when the application runs.

Example: Using an alias (MYDEV1) for an I/O resource

```
Set msg = rm.Open("MYDEV1", NO_LOCK, 0, "")
```

When you use aliases, specify the actual I/O resources through an external configuration table or similar tool. The following figure shows an example of using KI-VISA with the USB interface.

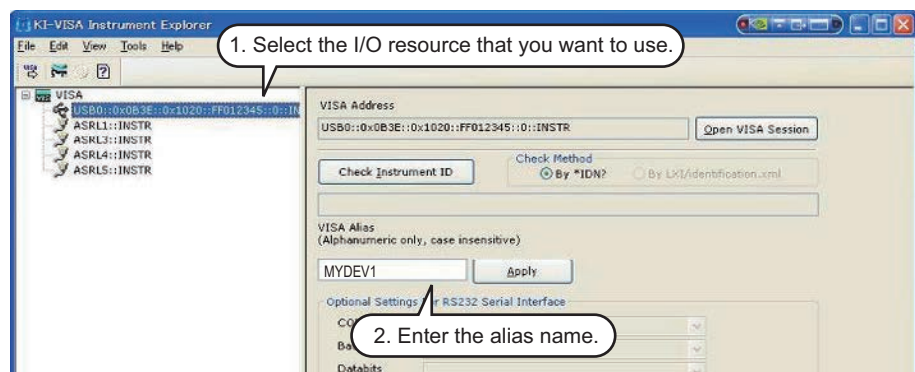

If you are using a version of VISA other than KI-VISA, see the manual of your VISA version.

## ■ Controlling the instrument

Next, we will use commands such as read and write commands to control the instrument.

Example: `msg.WriteString ("SOUR:VOLT 1.5KV")` ' Sets the test voltage to 1.5 kV  
`msg.WriteString ("SOUR:VOLT:PROT 2KV")` ' Sets the limit voltage to 2 kV  
`msg.WriteString ("SENS:JUDG 10MA")` ' Sets the upper limit for judgments to 10 mA

## ■ Closing VISA

Finally, close VISA.

In a sequence of operations, you only have to open and close VISA once.

```
msg.Close
```

## Sample program

```
Imports Ivi.Visa.Interop

Public Class Form1

    Dim rm As ResourceManager
    Dim msg As IMessage

    Private Sub Form1_Load(ByVal sender As System.Object, ByVal e As System.EventArgs) Handles MyBase.Load
        rm = CreateObject("VISA.GlobalRM")
        'msg = rm.Open("MYDEV1", AccessMode.NO_LOCK, 0, "") ' Version using a VISA alias
        'msg = rm.Open("USB0::0x0B3E::0x1046::FF012345::INSTR", AccessMode.NO_LOCK, 0, "") ' Version using USB
    End Sub

    ' Queries the ID
    Private Sub cmdIdn_Click(ByVal sender As System.Object, ByVal e As System.EventArgs) Handles cmdIdn.Click
        msg.WriteString("*IDN?")
        TextBox1.Text = msg.ReadString(256)
    End Sub

    ' Sets the test voltage, limit voltage, and upper limit for judgments
    Private Sub cmdCurr_Click(ByVal sender As System.Object, ByVal e As System.EventArgs) Handles cmdCurr.Click
        msg.WriteString("SOUR:VOLT 1.5KV") ' Sets the test voltage to 1.5 kV
        msg.WriteString("SOUR:VOLT:PROT 2KV") ' Sets the limit voltage to 2 kV
        msg.WriteString("SENS:JUDG 10MA") ' Sets the upper limit for judgments to 10 mA
    End Sub

    ' Queries the measured values
    Private Sub cmdMeas_Click(ByVal sender As System.Object, ByVal e As System.EventArgs) Handles cmdMeas.Click
        msg.WriteString("MEAS:VOLT?") ' Queries the measured voltage
        TextBox1.Text = msg.ReadString(256) ' Reads 256 bytes of data from the reception buffer, converts the string into a number,
        ' and assigns the converted value to a variable

        msg.WriteString("MEAS:CURRE?") ' Queries the measured current
        TextBox1.Text = msg.ReadString(256) ' Reads 256 bytes of data from the reception buffer, converts the string into a number,
        ' and assigns the converted value to a variable

    End Sub

    Private Sub Form1_Disposed(ByVal sender As Object, ByVal e As System.EventArgs) Handles Me.Disposed
        msg.Close()
    End Sub
End Class
```

# Index

<b>B</b>	
boolean data .....	16
<b>C</b>	
character data .....	16
command	
description .....	20
hierarchy .....	14
processing time .....	67
syntax .....	14
unit .....	17
common commands .....	16, 21
CONDition register .....	40
CONFIG setup screen .....	9, 11
<b>E</b>	
ENABLE register .....	40
error list .....	63
EVENT register .....	40
event status register .....	43
<b>F</b>	
firmware version .....	2
<b>I</b>	
IEEE Std 488.2 .....	6
interface .....	6
<b>M</b>	
messages .....	14
messages, list of .....	58
<b>N</b>	
NRf .....	17
Numeric .....	17
<b>O</b>	
OPERation status register .....	44
<b>P</b>	
parameters .....	16
PROtecting status register .....	46
<b>Q</b>	
queries .....	15
QUESTionable status register .....	50
<b>R</b>	
remote control	
error list .....	63
remote interfaces .....	6
<b>S</b>	
sample program .....	70
SCPI .....	6, 14
status byte register .....	42
status register .....	40
string data .....	16
<b>T</b>	
terminator .....	16
TESTing status register .....	48
transition filters .....	40
tutorial .....	56
<b>V</b>	
version .....	2
VISA library .....	7





If you find any misplaced or missing pages in the manuals, they will be replaced. If the manual gets lost or soiled, a new copy can be provided for a fee. In either case, please contact your Kikusui agent or distributor. At that time, inform your agent or distributor of the "Part No." written on the front cover of this manual.

Every effort has been made to ensure the accuracy of this manual. However, if you have any questions or find any errors or omissions, please contact your Kikusui agent or distributor.

After you have finished reading this manual, store it so that you can use it for reference at any time.

## **KIKUSUI ELECTRONICS CORP.**

---

1-1-3 Higashiyamata, Tsuzuki-ku, Yokohama,  
224-0023, Japan

Tel: +81-45-482-6353

Fax: +81-45-482-6261

**[www.kikusui.co.jp/en](http://www.kikusui.co.jp/en)**

