

Communication Interface Manual

PCR-WEA Series AC Power Supply

PCR1000WEA

PCR2000WEA

PCR-WEA2 Series AC Power Supply

PCR3000WEA2

PCR6000WEA2/PCR6000WEA2R

PCR12000WEA2/PCR12000WEA2R

PCR18000WEA2/PCR18000WEA2R

PCR24000WEA2/PCR24000WEA2R

PCR30000WEA2/PCR30000WEA2R

PCR36000WEA2/PCR36000WEA2R

Contents

Command List	7	*PSC.....	66
Introduction	26	*RCL.....	67
Reading environment.....	26	*RST.....	68
Intended readers.....	26	*SAV.....	71
Structure of the manual.....	27	*SRE.....	72
Trademarks.....	27	*STB.....	73
Firmware version of the product to which this manual applies.....	27	*TRG.....	74
Measuring instrument interface standards 28		*TST.....	75
Copyright.....	28	*WAI.....	76
VISA Library	29	ABORt Command	77
Setting Up the Interface	30	ABOR.....	77
RS232C (standard).....	31	ABOR:ACQ.....	78
USB (standard).....	34	ABOR:PROG.....	79
LAN (standard).....	35	ABOR:SIM.....	80
Accessing and Operating the Product from a Web Browser (LAN).....	41	ABOR:TRAN.....	81
GPIB (option).....	50	DISPlay Command	82
About Commands	52	DISP:CONT.....	82
Command Hierarchy.....	52	DISP:PHAS.....	83
Command Syntax.....	53	DISP:MMOD:CURR.....	84
Parameters	56	DISP:MMOD:VOLT.....	85
Non-numeric parameters.....	56	DISP:MMOD:VOLT:LTL.....	86
Numeric parameters.....	57	HCOPy Command	87
Special form numeric parameters.....	58	HCOP:SDUM:DATA?.....	87
Phase designation (channel list).....	59	INITiate Command	88
Measurement units.....	59	INIT:ACQ.....	88
IEEE 488.2 common commands .60		INIT:PROG.....	89
*CLS.....	60	INIT:SIM.....	90
*ESE.....	61	INIT:TRAN.....	91
*ESR.....	62	INSTrument Command	92
*IDN.....	63	INST/ INST:NSEL.....	92
*OPC.....	64	INST:COUP.....	93
*OPT.....	65	LXI Command	94
		LXI:IDEN.....	94
		MEASure/FETCH Command	95

FETC:<meas-item>/ MEAS:<meas-item>	96	PROG:EDIT:VOLT:OFFS	136
F E T C : A R R : < h a r m - i t e m > ? /		PROG:EXEC	137
MEAS:ARR:<harm-item>?.....	98	PROG:LOOP	138
MEMory Command.....	99	PROG:STAT.....	139
MEM:REC.....	99	PROG:STEP:END	140
MEM:REC:CONF.....	100	PROG:STEP:STAR	141
MEM:REC:PREV	101	SENSe Command	142
MEM:SAVE	102	SENS:AVER:COUN.....	142
OUTPut Command.....	103	SENS:CURR:HOLD:CLE.....	143
OUTP.....	103	SENS:CURR:HOLD:TIME	144
OUTP:IMP	104	SENS:VOLT:AVER:COUN	145
OUTP:IMP:REAC	105	SENS:VOLT:HOLD:CLE	146
OUTP:IMP:REAL	107	SENS:VOLT:HOLD:TIME.....	147
OUTP:PHAS:OFF	108	SIMulation Command.....	148
OUTP:PHAS:OFF:LEV	109	SIM:EXEC.....	148
OUTP:PHAS:ON.....	110	SIM:POL	149
OUTP:PHAS:ON:LEV.....	111	SIM:REP:COUN	150
OUTP:PON	112	SIM:STAT	151
OUTP:PROT:CLE	113	SIM:T1:PHAS	152
OUTP:PROT:WDOG.....	114	SIM:T1:PHAS:STAT	153
OUTP:PROT:WDOG:DEL.....	115	SIM:T1:TIME.....	154
OUTP:SST.....	116	SIM:T2:TIME.....	155
OUTP:SST:FALL.....	117	SIM:T3:TIME.....	156
OUTP:SST:TIME.....	118	SIM:T3:VOLT	157
OUTP:SST:TIME:FALL	119	SIM:T4:TIME.....	158
PROGram Command.....	120	SIM:T5:CYCL.....	159
PROG:CLE	120	SIM:T5:CYCL:STAT	160
PROG:EDIT	121	SIM:T5:TIME.....	161
PROG:EDIT:FUNC:BANK.....	123	[SOURce:]CURRent Command .	162
PROG:EDIT:JUMP.....	124	CURR	162
PROG:EDIT:IMP	125	CURR:PEAK.....	163
PROG:EDIT:IMP:REAC	126	CURR:PEAK:LOW.....	164
PROG:EDIT:IMP:REAL.....	128	CURR:PROT:STAT	165
PROG:EDIT:PHAS:RAMP	129	CURR:PROT:TRIP:DEL.....	166
PROG:EDIT:PHAS:STAR	130	[SOURce:]FREQuency Command...	167
PROG:EDIT:PHAS:STOP	131	FREQ.....	167
PROG:EDIT:PHAS:UOFF.....	132	FREQ:LIM:LOW.....	168
PROG:EDIT:PHAS:UV.....	133	FREQ:LIM:UPP	169
PROG:EDIT:PHAS:UW.....	134	FREQ:SYNC.....	170
PROG:EDIT:VOLT	135		

FREQ:SYNC:MODE	171
FREQ:SYNC:PHAS:DEL	172
FREQ:TRIG	173

[SOURce:]FUNCTion Command 174

FUNC:BANK	174
-----------------	-----

[SOURce:]VOLTage Command.. 175

VOLT	175
VOLT:COMP:MODE	176
VOLT:COMP:RADJ	177
VOLT:COMP:SOFT:CONT	178
VOLT:COMP:SOFT:TERM	179
VOLT:EXT:INP:EXTDC:ADJ:GAIN	180
VOLT:EXT:INP:EXTDC:ADJ:OFFS	181
VOLT:EXT:INP:EXTDC:APER	182
VOLT:EXT:INP:EXTDC:SIGN:POL	183
VOLT:EXT:INP:EXTDC:SIGN:SOUR	184
VOLT:EXT:INP:FUNC:MODE	185
VOLT:EXT:INP:VPR:ADJ:GAIN	186
VOLT:EXT:INP:VPR:ADJ:OFFS	187
VOLT:EXT:INP:VPR:MAP	188
VOLT:EXT:INP:VPR:STAT	189
VOLT:LIM:LOW	190
VOLT:LIM:UPP	191
VOLT:LTL	192
VOLT:OFFS	193
VOLT:OFFS:LIM:LOW	194
VOLT:OFFS:LIM:UPP	195
VOLT:OFFS:LTL	196
VOLT:OFFS:TRIG	197
VOLT:PROT:LOW	198
VOLT:PROT:PEAK:LOW	199
VOLT:PROT:PEAK:UPP	200
VOLT:PROT:LOW:STAT	201
VOLT:PROT:UPP	202
VOLT:RANG	203
VOLT:RESP	204
VOLT:TRIG	205

STATus Command206

Status Report Structure	206
Architecture	208
Status byte register	209

Event status register	210
OPERation status register	211
STAT:OPER	212
STAT:OPER:COND	213
STAT:OPER:ENAB	214
STAT:OPER:NTR	215
STAT:OPER:PTR	216
OPERation:INSTrument subregister	217
STAT:OPER:INST	218
STAT:OPER:INST:COND	219
STAT:OPER:INST:ENAB	220
STAT:OPER:INST:NTR	221
STAT:OPER:INST:PTR	222
OPERation:INSTrument:ISUMmary{1 2 3} subregister	223
STAT:OPER:INST:ISUM{1 2 3}	224
STAT:OPER:INST:ISUM{1 2 3}:COND	225
STAT:OPER:INST:ISUM{1 2 3}:ENAB	226
STAT:OPER:INST:ISUM{1 2 3}:NTR	227
STAT:OPER:INST:ISUM{1 2 3}:PTR	228
QUESTionable status register	229
STAT:QUES	230
STAT:QUES:COND	231
STAT:QUES:ENAB	232
STAT:QUES:NTR	233
STAT:QUES:PTR	234
QUESTionable:INSTrument subregister	235
STAT:QUES:INST	236
STAT:QUES:INST:COND	237
STAT:QUES:INST:ENAB	238
STAT:QUES:INST:NTR	239
STAT:QUES:INST:PTR	240
QUESTionable:INSTrument:ISUMmary{1 2 3} subregister	241
STAT:QUES:INST:ISUM{1 2 3}	242
STAT:QUES:INST:ISUM{1 2 3}:COND	243
STAT:QUES:INST:ISUM{1 2 3}:ENAB	244
STAT:QUES:INST:ISUM{1 2 3}:NTR	245
STAT:QUES:INST:ISUM{1 2 3}:PTR	246
Preset status	247
STAT:PRES	247

SYSTem Command	248	SYST:EXT:SIGIN:POL	283
SYST:COMM:RLST	248	SYST:EXT:SIGIN:STAT	284
SYST:CONF:ACC	249	SYST:EXT:SIGOUT:MAP	285
SYST:CONF:ADJ:VOLT:FINE	250	SYST:EXT:SIGOUT:POL	286
SYST:CONF:ADJ:VOLT:TERM:MODE	251	SYST:EXT:SIGOUT:STAT	287
SYST:CONF:FORM:FRAM	252	SYST:EXT:SSIGIO:MAP	288
SYST:CONF:FORM:FRAM:INFO	253	SYST:EXT:SSIGIO:POL	290
SYST:CONF:FORM:PMOD	254	SYST:EXT:SSIGIO:STAT	291
SYST:CONF:FORM:PMOD:INFO	255	SYST:KLOC	292
SYST:CONF:FORM:PSAV:MAX	256	SYST:LOC/ SYST:REM/ SYST:RWL	293
SYST:CONF:FORM:PSAV:MOD	257	SYST:OPT	294
SYST:CONF:FORM:PSAV:RES	258	SYST:PASS	295
SYST:CONF:PHAS:UOFF	259	SYST:PASS:CDIS	296
SYST:CONF:PHAS:UV	260	SYST:PASS:NEW	297
SYST:CONF:PHAS:UW	261	SYST:PASS:STAT	298
SYST:CONF:PON:STAT	262	SYST:SEC:IMM	299
SYST:CONF:SSUP	263	SYST:SLE	300
SYST:CONF:TPH:MODE	264	SYST:SLE:EXEC	301
SYST:CONF:WIR/ SYST:CONF:NOUT	265	SYST:SLE:TIME	302
SYST:DATE	266	SYST:TIME	303
SYST:ERR	267	SYST:TIME:ADJ	304
SYST:ERR:COUN	268	SYST:TZON	305
SYST:EXT:DIG:READ	269	SYST:TZON:CAT	306
SYST:EXT:DIG:WRIT	270	SYST:VERS	307
SYST:EXT:MON:OUTP:ADJ:FMON:GAIN	271		
SYST:EXT:MON:OUTP:ADJ:FMON:OFFS	272	TRIGger Command	308
SYST:EXT:MON:OUTP:ADJ:IMON:GAIN	273	TRIG:ACQ	308
SYST:EXT:MON:OUTP:ADJ:IMON:OFFS	274	TRIG:ACQ:SOUR	309
SYST:EXT:MON:OUTP:ADJ:PMON:GAIN	275	TRIG:PROG	310
SYST:EXT:MON:OUTP:ADJ:PMON:OFF	276	TRIG:PROG:SOUR	311
SYST:EXT:MON:OUTP:ADJ:VMON:GAIN	277	TRIG:SIM	312
SYST:EXT:MON:OUTP:ADJ:VMON:OFFS	278	TRIG:SIM:SOUR	313
SYST:EXT:MON:OUTP:MAP	279	TRIG:TRAN	314
SYST:EXT:MON:OUTP:STAT	281	TRIG:TRAN:SOUR	315
SYST:EXT:SIGIN:MAP	282		
		WAVE Command	316
		WAVE:DATA:ARB	316
		WAVE:DATA:CLIP	317
		WAVE:DATA:IECP	318
		WAVE:DATA:POIN	319
		WAVE:DATA:SIN	320
		WAVE:DATA:TYPE	321
		List of Errors	322

Command errors.....	322
Execution errors.....	323
Product-specific errors.....	324
Query errors.....	324
Operation complete event errors	325
Product-dependent errors.....	325

Command processing time328

Tutorial.....329

Programming AC Output.....	329
Programming DC Output	331
Trigger Subsystem.....	332
Changing the output with triggers (TRANsient).....	334
Measurement (ACQuire).....	337
Power line abnormality simulations (SIMulation)	342
Sequence Operation (PROGram).....	345
Waiting for Operation Complete	348
Status Monitoring.....	349
Error Checking.....	352
Visual Basic 2017	353

Command List

IEEE 488.2 common commands

*CLS

Clears all event registers including the status byte, event status, and error queue.

*ESE

Sets the event status enable register that is counted by the event summary bit (ESB) of the status byte.

*ESR

Queries the event status register. The event status register is cleared when read.

*IDN

Queries the model name and firmware version of the product.

*OPC

Sets the OPC bit (bit 0) of the event status register when all the commands that are in standby have been processed.

*OPT

Queries the optional interface boards that are installed in the product.

*PSC

Sets whether the event status enable register and service request enable register are cleared when the POWER switch is turned on.

*RCL

Recalls memory content.

*RST

Resets a portion of the product settings.

*SAV

Saves the panel settings to memory.

*SRE

Sets the service request enable register.

*STB

Queries the contents of the status byte register and the MSS (master summary status) message.

***TRG**

Trigger command.

***TST**

Executes a self-test.

***WAI**

Prevents the device from executing subsequent commands until all operations that are in standby have completed.

ABORt Command

ABOR

Aborts configuration, changes, measurements, and other operations in all trigger subsystems (TRANsient, ACQuire, SIMulation, PROGram).

ABOR:ACQ

Aborts measurement operations.

ABOR:PROG

Stops the trigger function of the sequence operation.

ABOR:SIM

Aborts the trigger function of the power line abnormality simulation.

ABOR:TRAN

Aborts the trigger function for configuration changes.

DISPlay Command

DISP:CONT

Adjusts the screen brightness.

DISP:PHAS

Selects the phase to display on the panel.

DISP:MMOD:CURR

Sets the current, power, or power factor to display on the screen.

DISP:MMOD:VOLT

Sets the voltage (rms value, peak value, average value) to display on the screen.

DISP:MMOD:VOLT:LTL

Sets the voltage (phase voltage, line voltage) to display on the screen.

HCOpy Command

HCOpy:SDUM:DATA?

Retrieves the screen capture of the present screen.

INITiate Command

INIT:ACQ

These commands invalidate the present measured data and start a new measurement.

INIT:PROG

Executes a sequence.

INIT:SIM

Executes a power line abnormality simulation.

INIT:TRAN

Starts the trigger function.

INSTrument Command

INST/ INST:NSEL

Selects the phase that SOURce and MEASure/FETCH commands apply to.

INST:COUP

Sets whether to select all phases.

LXI Command

LXI:IDEN

Turns the identification display on or off.

MEASure/FETCH Command

FETC:<meas-item>/ MEAS:<meas-item>

Queries the scalar measurement data specified with <meas-item>.

FETC:ARR:<harm-item>?/ MEAS:ARR:<harm-item>?

Queries the harmonic data specified with <harm-item>.

MEMory Command

MEM:REC

Recalls contents saved in the ABC memory.

MEM:REC:CONF

Sets whether the memory content is to be confirmed before recalling the ABC memory from the panel.

MEM:REC:PREV

Displays the contents that are stored in the ABC memory.

MEM:SAVE

Saves the frequency, AC voltage, DC voltage, and waveform bank number to memory.

OUTPut Command

OUTP

Set the output to on or off.

OUTP:IMP

Enables or disables the output impedance.

OUTP:IMP:REAC

Sets the reactance component of the output impedances.

OUTP:IMP:REAL

Sets the resistance component of the output impedances.

OUTP:PHAS:OFF

Enables or disables output-off phase control.

OUTP:PHAS:OFF:LEV

Sets the output off phase angle.

OUTP:PHAS:ON

Enables or disables output-on phase control.

OUTP:PHAS:ON:LEV

Sets the output-on phase angle.

OUTP:PON

Sets the output state that the PCR-WEA will be in when the power is turned on.

OUTP:PROT:CLE

Clears alarms.

OUTP:PROT:WDOG

Enables or disables the communication monitoring (WATCHDOG) timer.

OUTP:PROT:WDOG:DEL

Sets the delay time of the communication monitoring (WATCHDOG) timer.

OUTP:SST

Enables or disables soft start.

OUTP:SST:FALL

Enables or disables soft stop.

OUTP:SST:TIME

Sets the soft start rise time.

OUTP:SST:TIME:FALL

Sets the soft stop fall time.

PROGram Command

PROG:CLE

Sets all the steps in the sequence to their default values.

PROG:EDIT

Collectively sets a sequence step (frequency, voltage, signal change, step time, waveform bank, status output, trigger I/O, output).

PROG:EDIT:FUNC:BANK

Sets the waveform bank number of the sequence step.

PROG:EDIT:JUMP

Configures the jump settings of a sequence step.

PROG:EDIT:IMP

Sets whether to set the output impedance in the sequence step.

PROG:EDIT:IMP:REAC

Sets the reactance component of the output impedance used in the sequence step.

PROG:EDIT:IMP:REAL

Sets the resistance component of the output impedance used in the sequence step.

PROG:EDIT:PHAS:RAMP

Sets the phase signal change of a sequence step.

PROG:EDIT:PHAS:STAR

Sets the starting phase angle and whether to suddenly change the phase of the sequence step.

PROG:EDIT:PHAS:STOP

Sets the ending phase angle of the sequence step.

PROG:EDIT:PHAS:UOFF

Sets the U phase offset phase angle of a sequence step.

PROG:EDIT:PHAS:UV

Sets the U-V phase difference of the sequence step.

PROG:EDIT:PHAS:UW

Sets the U-W phase difference of the sequence step.

PROG:EDIT:VOLT

Sets the unbalanced AC voltage of the sequence step

PROG:EDIT:VOLT:OFFS

Sets the unbalanced DC voltage of the sequence step

PROG:EXEC

Queries the sequence execution state.

PROG:LOOP

Sets the sequence repetition count.

PROG:STAT

Changes the execution state of the sequence.

PROG:STEP:END

Sets the sequence ending step number

PROG:STEP:STAR

Sets the sequence starting step number

SENSe Command

SENS:AVER:COUN

Sets the moving average count for current measurement.

SENS:CURR:HOLD:CLE

Clears the hold of the peak current value.

SENS:CURR:HOLD:TIME

Sets the hold time of the peak current.

SENS:VOLT:AVER:COUN

Sets the moving average count for voltage measurement.

SENS:VOLT:HOLD:CLE

Clears the hold of the peak voltage value.

SENS:VOLT:HOLD:TIME

Sets the hold time of the peak voltage.

SIMulation Command

SIM:EXEC

Queries the execution status of power line abnormality simulations.

SIM:POL

Sets the voltage regulation polarity of power line abnormality simulations.

SIM:REP:COUN

Sets the number of repetitions of power line abnormality simulations.

SIM:STAT

Executes or stops a power line abnormality simulation.

SIM:T1:PHAS

Sets the voltage regulation starting phase of power line abnormality simulations.

SIM:T1:PHAS:STAT

Selects whether the voltage regulation start of power line abnormality simulations will be set in terms of time or in terms of phase.

SIM:T1:TIME

Sets the voltage regulation starting time of power line abnormality simulations.

SIM:T2:TIME

Sets slope time 1 of power line abnormality simulations.

SIM:T3:TIME

Sets the voltage regulation time of power line abnormality simulations.

SIM:T3:VOLT

Sets the regulated voltage of power line abnormality simulations.

SIM:T4:TIME

Sets slope time 2 of power line abnormality simulations.

SIM:T5:CYCL

Sets the number of return cycles of power line abnormality simulations.

SIM:T5:CYCL:STAT

Selects whether the period that the PCR-WEA remains in the returned state is configured in terms of time or in terms of cycles for power line abnormality simulations.

SIM:T5:TIME

Sets the return time of power line abnormality simulations.

[SOURce:]CURRent Command

CURR

Sets the upper limit of the output current.

CURR:PEAK

Sets the output current peak limit of the positive electric potential

CURR:PEAK:LOW

Sets the output current peak limit of the negative electric potential

CURR:PROT:STAT

Sets how the PCR-WEA acts when the current limit is exceeded.

CURR:PROT:TRIP:DEL

Sets the time that must elapse before the output is turned off when the current limit is exceeded

[SOURCE:]FREQUENCY Command

FREQ

Sets the frequency.

FREQ:LIM:LOW

Sets the lower frequency limit.

FREQ:LIM:UPP

Sets the upper frequency limit.

FREQ:SYNC

Sets the sync function.

FREQ:SYNC:MODE

Sets the input sync signal of the sync function.

FREQ:SYNC:PHAS:DEL

Sets the synchronization delay phase angle of the synchronization function.

FREQ:TRIG

Sets the frequency to change to when INIT/INIT:TRAN or a software trigger is sent.

[SOURCE:]FUNCTION Command

FUNC:BANK

Specifies the number of the waveform bank that you want to execute.

[SOURCE:]VOLTAGE Command

VOLT

Set the AC voltage.

VOLT:COMP:MODE

Sets the compensation (voltage compensation).

VOLT:COMP:RADJ

Sets the voltage to correct with regulation adjustment.

VOLT:COMP:SOFT:CONT

Set the soft sensing control target.

VOLT:COMP:SOFT:TERM

Set the sensing point.

VOLT:EXT:INP:EXTDC:ADJ:GAIN

Sets the gain for when the input waveform is amplified using an external analog signal.

VOLT:EXT:INP:EXTDC:ADJ:OFFS

Sets the offset for when the input waveform is amplified using an external analog signal.

VOLT:EXT:INP:EXTDC:APER

Sets the measurement time for when the input waveform is amplified using an external analog signal.

VOLT:EXT:INP:EXTDC:SIGN:POL

Sets the signal polarity of each channel for when the input waveform is amplified using an external analog signal.

VOLT:EXT:INP:EXTDC:SIGN:SOUR

Sets the signal source for when the input waveform is amplified using an external analog signal.

VOLT:EXT:INP:FUNC:MODE

Selects the parameter to control with the external analog signal.

VOLT:EXT:INP:VPR:ADJ:GAIN

Sets the gain for when varying the voltage or frequency with the external analog signal.

VOLT:EXT:INP:VPR:ADJ:OFFS

Sets the offset for when varying the voltage or frequency with the external analog signal.

VOLT:EXT:INP:VPR:MAP

Sets the channel configuration for when varying the voltage or frequency with the external analog signal.

VOLT:EXT:INP:VPR:STAT

Turns on or off the output of each channel for when varying the voltage or frequency with the external analog signal.

VOLT:LIM:LOW

Sets the lower AC voltage limit.

VOLT:LIM:UPP

Sets the upper AC voltage limit.

VOLT:LTL

Sets the line AC voltage.

VOLT:OFFS

Sets the DC voltage.

VOLT:OFFS:LIM:LOW

Sets the lower DC voltage limit.

VOLT:OFFS:LIM:UPP

Sets the upper DC voltage limit.

VOLT:OFFS:LTL

Sets the line DC voltage.

VOLT:OFFS:TRIG

Sets the DC voltage to change to when INIT:TRAN or a software trigger is sent.

VOLT:PROT:LOW

Sets the UVP value.

VOLT:PROT:PEAK:LOW

Sets the negative peak OVP value.

VOLT:PROT:PEAK:UPP

Sets the positive peak OVP value.

VOLT:PROT:LOW:STAT

Enables/disables UVP.

VOLT:PROT:UPP

Sets the OVP (rms) value.

VOLT:RANG

Sets the voltage range.

VOLT:RESP

Sets the response speed.

VOLT:TRIG

Sets the AC voltage to change to when INIT:TRAN or a software trigger is sent.

STATus Command

STAT:OPER

Queries the event of the OPERation status register.

STAT:OPER:COND

Queries the condition of the OPERation status register.

STAT:OPER:ENAB

Sets the enable register of the OPERation status register.

STAT:OPER:NTR

Sets the negative transition filter of the OPERation status register.

STAT:OPER:PTR

Sets the positive transition filter of the OPERation status register.

STAT:OPER:INST

Queries the event of the OPERation:INSTrument subregister.

STAT:OPER:INST:COND

Queries the condition of the OPERation:INSTrument subregister.

STAT:OPER:INST:ENAB

Sets the enable register of the OPERation:INSTrument subregister.

STAT:OPER:INST:NTR

Sets the negative transition filter of the OPERation:INSTrument subregister.

STAT:OPER:INST:PTR

Sets the positive transition filter of the OPERation:INSTrument subregister.

STAT:OPER:INST:ISUM{1|2|3}

Queries the event of the OPERation:INSTrument:ISUMmary{1|2|3} subregister.

STAT:OPER:INST:ISUM{1|2|3}:COND

Queries the condition of the OPERation:INSTrument:ISUMmary{1|2|3} subregister.

STAT:OPER:INST:ISUM{1|2|3}:ENAB

Sets the enable register of the OPERation:INSTrument:ISUMmary{1|2|3} subregister.

STAT:OPER:INST:ISUM{1|2|3}:NTR

Sets the negative transition filter of the OPERation:INSTrument:ISUMmary{1|2|3} subregister.

STAT:OPER:INST:ISUM{1|2|3}:PTR

Sets the positive transition filter of the OPERation:INSTrument:ISUMmary{1|2|3} subregister.

STAT:QUES

Queries the event of the QUEStionable status register.

STAT:QUES:COND

Queries the condition of the QUEStionable status register.

STAT:QUES:ENAB

Sets the enable register of the QUEStionable status register.

STAT:QUES:NTR

Sets the negative transition filter of the QUEStionable status register.

STAT:QUES:PTR

Sets the positive transition filter of the QUEStionable status register.

STAT:QUES:INST

Queries the event of the QUEStionable:INSTrument subregister.

STAT:QUES:INST:COND

Queries the condition of the QUEStionable:INSTrument subregister.

STAT:QUES:INST:ENAB

Sets the enable register of the QUEStionable:INSTrument subregister.

STAT:QUES:INST:NTR

Sets the negative transition filter of the QUEStionable:INSTrument subregister.

STAT:QUES:INST:PTR

Sets the positive transition filter of the QUEStionable:INSTrument subregister.

STAT:QUES:INST:ISUM{1|2|3}

Queries the event of the QUEStionable:INSTrument:ISUMmary{1|2|3} subregister.

STAT:QUES:INST:ISUM{1|2|3}:COND

Queries the condition of the QUEStionable:INSTrument:ISUMmary{1|2|3} subregister.

STAT:QUES:INST:ISUM{1|2|3}:ENAB

Sets the enable register of the QUEStionable:INSTrument:ISUMmary{1|2|3} subregister.

STAT:QUES:INST:ISUM{1|2|3}:NTR

Sets the negative transition filter of the QUESTIONable:INSTrument:ISUMmary{1|2|3} sub-register.

STAT:QUES:INST:ISUM{1|2|3}:PTR

Sets the positive transition filter of the QUESTIONable:INSTrument:ISUMmary{1|2|3} subregister.

STAT:PRES

Resets the ENABLE, PTRansition, and NTRansition filter registers of all status registers (including sub registers) to their default values.

SYSTEM Command

SYST:COMM:RLST

Sets the product to remote or local mode.

SYST:CONF:ACC

Enables/disables AC coupling.

SYST:CONF:ADJ:VOLT:FINE

Sets the output voltage offset.

SYST:CONF:ADJ:VOLT:TERM:MODE

Set whether the sensing function is enabled or disabled for the voltage offset setting.

SYST:CONF:FORM:FRAM

Queries the number of units operating in parallel.

SYST:CONF:FORM:FRAM:INFO

Queries the information about the specified PCR-WE/ PCR-WEA.

SYST:CONF:FORM:PMOD

Queries the number of power modules.

SYST:CONF:FORM:PMOD:INFO

Queries the information about the specified power module.

SYST:CONF:FORM:PSAV:MAX

Sets the maximum expected power of the power-saving function.

SYST:CONF:FORM:PSAV:MOD

Sets all power modules to run using the power-saving function.

SYST:CONF:FORM:PSAV:RES

Resets the maximum expected power setting of the power-saving function.

SYST:CONF:PHAS:UOFF

Sets the absolute phase angle of the U phase relative to the reference phase.

SYST:CONF:PHAS:UV

Sets the U-V phase difference.

SYST:CONF:PHAS:UW

Sets the U-W phase difference.

SYST:CONF:PON:STAT

Sets the condition panel setting state when the POWER switch is turned on.

SYST:CONF:SSUP

Enables or disables the voltage surge suppression function.

SYST:CONF:TPH:MODE

Set whether to use single-phase three-wire output or two-phase output.

SYST:CONF:WIR/ SYST:CONF:NOUT

Sets the output method.

SYST:DATE

Sets the date (UTC).

SYST:ERR

Reads the oldest error information or event information from the error queue.

SYST:ERR:COUN

Queries the number of errors occurring currently.

SYST:EXT:DIG:READ

Queries all the signal input states of SIGNAL IN channels (CTRL.1 to CTRL.4) and SIGNAL IO channels (DIO.1, DIO.2).

SYST:EXT:DIG:WRIT

Outputs the SIGNAL OUT channels (STAT.1 to STAT.4) and SIGNAL IO channels (DIO.1, DIO.2) collectively.

SYST:EXT:MON:OUTP:ADJ:FMON:GAIN

Set the frequency gain of the analog monitor output.

SYST:EXT:MON:OUTP:ADJ:FMON:OFFS

Set the frequency offset of the analog monitor output.

SYST:EXT:MON:OUTP:ADJ:IMON:GAIN

Set the current gain of the analog monitor output.

SYST:EXT:MON:OUTP:ADJ:IMON:OFFS

Set the current offset of the analog monitor output.

SYST:EXT:MON:OUTP:ADJ:PMON:GAIN

Set the power gain of the analog monitor output.

SYST:EXT:MON:OUTP:ADJ:PMON:OFF

Set the power offset of the analog monitor output.

SYST:EXT:MON:OUTP:ADJ:VMON:GAIN

Set the voltage gain of the analog monitor output.

SYST:EXT:MON:OUTP:ADJ:VMON:OFFS

Set the voltage offset of the analog monitor output.

SYST:EXT:MON:OUTP:MAP

Maps Analog monitor output channels (Ch.A/ Ch.B/ Ch.C).

SYST:EXT:MON:OUTP:STAT

Enables or disables each channel of analog monitor output.

SYST:EXT:SIGIN:MAP

Maps SIGNAL IN channels (CTRL.1 to CTRL.3).

SYST:EXT:SIGIN:POL

Sets the polarity of the parameter to map to SIGNAL IN.

SYST:EXT:SIGIN:STAT

Queries the signal level of the SIGNAL IN channel.

SYST:EXT:SIGOUT:MAP

Maps SIGNAL OUT channels (STAT.1 to STAT.3).

SYST:EXT:SIGOUT:POL

Sets the polarity of the parameter to map to SIGNAL OUT.

SYST:EXT:SIGOUT:STAT

Sets the signal level of the SIGNAL OUT channel.

SYST:EXT:SSIGIO:MAP

Maps SIGNAL IO channels (DIO.1, DIO.2).

SYST:EXT:SSIGIO:POL

Sets the polarity of the parameter to map to SIGNAL IO.

SYST:EXT:SSIGIO:STAT

Sets the signal level of the SIGNAL IO channel.

SYST:KLOC

Sets or releases panel control lock.

SYST:LOC/ SYST:REM/ SYST:RWL

This is an old style command.

SYST:OPT

Queries the optional interface boards that are installed in the product.

SYST:PASS

Enables a password-protected command.

SYST:PASS:CDIS

Disable the password-protected command.

SYST:PASS:NEW

Set the password.

SYST:PASS:STAT

Queries whether a password-protected command is valid or invalid.

SYST:SEC:IMM

Sanitizes the product to its factory default settings.

SYST:SLE

Turns the sleep function on and off.

SYST:SLE:EXEC

Activates sleep mode immediately.

SYST:SLE:TIME

Sets the time that must elapse before the product enters sleep mode.

SYST:TIME

Sets the time.

SYST:TIME:ADJ

Automatically synchronizes the system clock using the NTP server on the network.

SYST:TZON

Sets the time zone of the system clock.

SYST:TZON:CAT

Queries the time zone IDs that can be used.

SYST:VERS

Queries the version of the SCPI specifications that the product complies with.

TRIGger Command

TRIG:ACQ

Executes a software trigger on the ACQuire trigger subsystem.

TRIG:ACQ:SOUR

Sets the condition (trigger source) for actually starting the measurement after the ACQuire trigger subsystem receives an INIT:ACQ.

TRIG:PROG

Executes a software trigger on the PROGram trigger subsystem.

TRIG:PROG:SOUR

Sets the condition (trigger source) for actually starting the sequence operation after the PROGram trigger subsystem receives an INIT:PROG.

TRIG:SIM

Executes a software trigger on the SIMulation trigger subsystem.

TRIG:SIM:SOUR

Sets the condition (trigger source) for actually executing the simulation after the SIMulation trigger subsystem receives an INIT:SIM.

TRIG:TRAN

Executes a software trigger on the TRANsient trigger subsystem.

TRIG:TRAN:SOUR

Sets the condition (trigger source) for actually changing the settings after the TRANsient trigger subsystem receives an INIT:TRAN.

WAVE Command

WAVE:DATA:ARB

Sets a user-defined waveform with block data at the waveform bank that you specify by its number.

WAVE:DATA:CLIP

Sets the crest factor of the peak clipped waveform at the waveform bank that you specify by its number.

WAVE:DATA:IECP

Sets the clip factor of the flat curve waveform at the waveform bank that you specify by its number.

WAVE:DATA:POIN

Sets a user-defined waveform by specifying the waveform bank number and the point.

WAVE:DATA:SIN

Sets the waveform bank that you specify by its number to sine wave.

WAVE:DATA:TYPE

Queries the waveform type at the waveform bank that you specify by its number.

Introduction

The PCR-WEA Series Communication Interface Manual explains the settings that are used to control the PCR-WEA series remotely through the following interfaces and the available commands.

- RS232C interface (standard)
- USB interface (standard)
- LAN interface (standard)
- GPIB interface (option)

When the product is operating under remote control, REMOTE appears on the front panel display. To switch the product back to local mode from the front panel, press LOCAL.

Reading environment

We recommend the following environment for viewing this manual.

PDF Reader: Adobe Reader

Intended readers

This manual is written for readers with sufficient basic knowledge of how to control measuring instruments using a PC.

Familiarize yourself with the syntax of the SCPI commands that are used with the product before you use them.

Structure of the manual

This manual consists of the following sections.

- Overview
- Setup
- Message Overview
- Command
- Appendix
- Tutorial

Trademarks

Internet Explorer and Visual Basic are a trademark of Microsoft Corporation in the United States and/or other countries.

All other company and product names used in this guide are trademarks or registered trademarks of their respective owners.

Firmware version of the product to which this manual applies

This manual applies to products with firmware versions 3.1x.

Measuring instrument interface standards

This product complies with the following standards.

- IEEE Std 488.2-1992 IEEE Standard Codes, Formats, Protocols, and Common Commands For Use With IEEE Std 488.1-1987
- IEEE Std 488.1-1987 IEEE Standard Digital Interface for Programmable Instrumentation
- Standard Commands for Programmable Instruments (SCPI) version 1999.0
- Universal Serial Bus Specification Rev 2.0
- Universal Serial Bus Test and Measurement Class Specification (USBTMC) Rev 1.0
- Universal Serial Bus Test and Measurement Class, Subclass USB488 Specification (USBTMC-USB488) Rev 1.0
- TCP/IP Instrument Protocol Specification VXI-11 Rev 1.0 1995
- TCP/IP-IEEE488.2 Interface Specification VXI-11.3 Draft 0.3 1995
- LXI Device Specification 2016 Rev 1.5
- LXI HiSLIP Extended Function Rev 1.02
- LXI Extended Function IPv6 Rev 1.1
- IVI-6.1 IVI High-Speed LAN Instrument Protocol (HiSLIP) Rev 1.1
- VPP-4.3 The VISA Library 2015 Rev 5.5

Copyright

The contents of this manual may not be reproduced, in whole or in part, without the prior consent of the copyright holder.

The specifications of this product and the contents of this manual are subject to change without prior notice.

Copyright©2021

VISA Library

VISA (Virtual Instrument Software Architecture) was developed by the IVI Foundation. It is the standard specification for measurement instrument connection software.

To use the VISA library (VISA COM) with the I/O library, the VISA library must be installed on the controller (Windows).

If you are controlling the instrument using RS232C or LAN communication from a PLC or microcomputer board, a VISA library is not required

To use the LAN interface to control the product, middleware that supports the SCPI-Telnet, VXI-11, HiSLIP, or SCPI-RAW protocol is required. The middleware is installed automatically by the VISA library.

You have to install one of the following VISA libraries (driver software that is implemented according to the VISA specifications).

- NI-VISA by NI Corporation (Ver. 5.1.1 or later)
- Keysight VISA (Keysight IO Libraries Suite 16.0 or later) by Keysight Technologies
- KI-VISA Ver. 5.0.4 or later

—Note—

- Do not install multiple VISA libraries on the same PC. Doing so may cause errors.
- Depending on the interface, you may not be able to use your VISA library if it is an older version than that specified.

Setting Up the Interface

The product is standard equipped with RS232C, USB, and LAN interfaces. In addition to a PC, remote control is possible from a PLC, microcomputer board, or the like that support non-procedural communication.

There is no need to switch interfaces. All interfaces can be used simultaneously. Each interface can be turned off using CONFIG settings.

[RS232C \(standard\)](#)

[USB \(standard\)](#)

[LAN \(standard\)](#)

[Accessing and Operating the Product from a Web Browser \(LAN\)](#)

[GPIB \(option\)](#)

WARNING

If the remote control via digital interface fails to work properly, an unexpected operation may occur that may cause electric shock, fire, physical damage to the DUT, and so on. If you are going to remotely control the PCR-WEA from a distance, take safety measures such as using a watchdog timer.

RS232C (standard)

■ RS232C connection

Turn off the product and the PC.

For the RS232C cable, use a D-sub, 9-pin, female-to-female crossover cable. The port pinout is shown below.

If you are not using flow control, you do not have to connect all the pins. (See the second crossover cable wiring example below.)

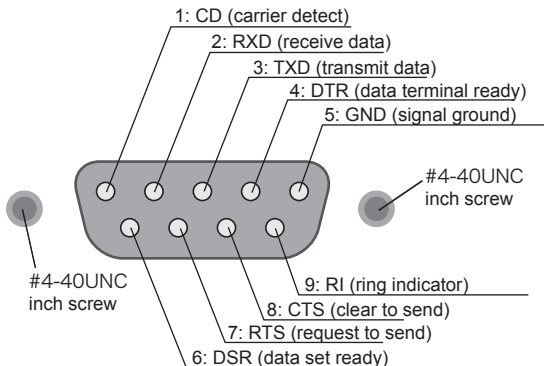

Viewing the front panel

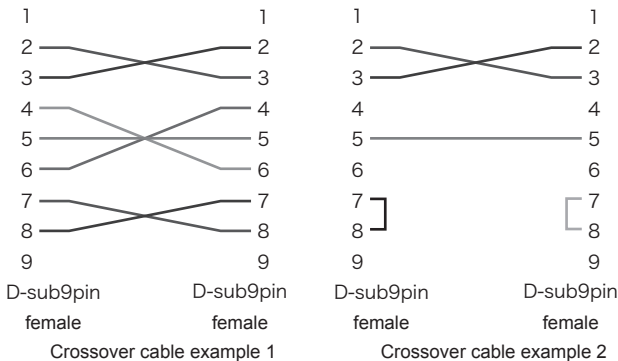

9-pin connector (Flow control cannot be performed using the cable described in the second crossover cable wiring example.)

■ RS232C settings

The RS232C protocol is shown in the following table.

The factory default RS232C settings are RS232C enabled and 19200 bps data rate.

Parameter	Value
Baudrate:	9 600 bps, <u>19 200 bps</u> , 38 400 bps, 57 600 bps, 115 200 bps
Data length:	8 bits
Stop bits:	1 bit
Parity:	None
Flow Ctrl:	NONE, <u>Xon/Xoff</u>

1

Press CONFIG (SHIFT+OPR MODE) > COM-I/F (F1) > RS232C (F3).

The present RS232C settings are displayed.

2

To enable RS232C, press ENABLE (F1). To disable it, press DISABLE (F2).

3

Press BITRATE (F3) to set the data rate.

For the settings, see the table under Protocol below.

4

Press FLOW CTRL (F4) to set flow control.

To disable flow control, press NONE (F1). To enable it, press XON/XOFF (F2).

5

Press ESC > APPLY (F5).

To cancel, press CANCEL (F6).

6

Turn the PCR-WEA's POWER switch off and then back on.

The settings take effect.

■ X-Flow control

The transmission/reception on the PCR-WEA/WEA2 can be controlled using Xon/Xoff. DC (device control) codes are used as control codes.

Data may not be received properly if flow control is not used.

Code	Function	ASCII Code
DC1 (Xon)	Transmission request	11H
DC3 (Xoff)	Transmission stop request	13H

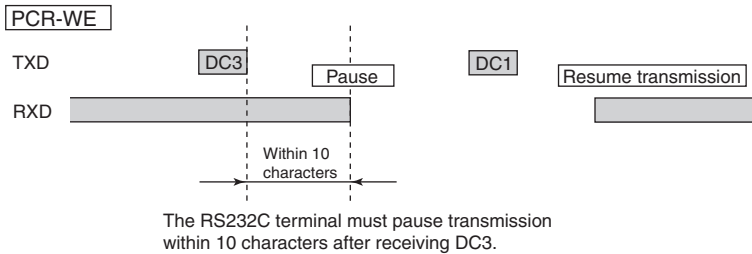

■ Break signal

The break signal is used as a substitute for the IEEE488.1 dcl/sdc (Device Clear, Selected Device Clear) message.

USB (standard)

To use the USB interface to control the product, a device driver that supports the USB Test & Measurement class (USBTMC) must be installed on the controller. The USBTMC driver is installed automatically by the VISA library.

■ USB connection

Connect the product to a PC using a USB cable.

■ USB settings

The factory default USB setting is "USB enabled."

- 1** Press **CONFIG (SHIFT+OPR MODE) > COM-I/F (F1) > USB (F2)**.
- 2** To enable USB, press **ENABLE (F1)**. To disable it, press **DISABLE (F2)**.
- 3** Press **APPLY (F5)**.
To cancel, press **CANCEL (F6)**.
- 4** Turn the **PCR-WEA's POWER switch off and then back on**.
The settings take effect.

■ Service request

The product is equipped with service request and serial polling functions.

■ USB function

Complies with USB Specification 2.0

Complies with USBTMC Specification 1.0 and USBTMC-USB488 Specification 1.0

Baud rate: 480 Mbps maximum (high speed)

VID (vendor ID)

0x0B3E

PID (product ID)

PCR-WEA: 0x104D

PCR-WEA2: 0x104E

PCR-WEA2R: 0x1054

LAN (standard)

To use the LAN interface to control the product, middleware that supports the SC-PI-Telnet, VXI-11, HiSLIP, or SCPI-RAW protocol is required. The middleware is installed automatically by the VISA library.

The LAN interface board has a Web browser interface (Web Browser Interface). You can configure the LAN interface settings from your PC's Web browser.

For information on topics such as connecting to your corporate LAN, your IP address, your host name, and security, contact your network administrator.

If you are using a host name (a Bonjour host name), you have to install Apple Bonjour.

Socket communication is possible with a PLC, microcomputer board, or the like that can communicate using the Telnet protocol.

■ LAN connection

Use a standard LAN cable (category 5 and straight) to connect the product to a network hub or router.

■ LAN settings

Checking the settings

For IPv4, press CONFIG (SHIFT+OPR MODE) > COM-I/F (F1) > LAN (F1). For IPv6, press CONFIG (SHIFT+OPR MODE) > COM-I/F (F1) > LAN (F1) > IPv6 (F6).

Parameter	IPv4 value	IPv6 value
Status	Present LAN status	
IP Address Source	IP address assignment	
Global Address	—	Global address
IP Address	IP address	—
LinkLocal Address	—	IP address
Subnet Mask	Subnet mask	—
Default Gateway	Default gateway	
DNS Servers	DNS server address	—
WINS Servers	WINS server address	—
Primary DNS	—	Primary DNS server address
Secondary DNS	—	Secondary DNS server address
mDNS Hostname	mDNS host name	
mDNS Service Name	mDNS service name	
DDNS Hostname	DDNS host name	
Domain	domain	
NetBIOS Name	NetBIOS name	—
SCPI-RAW Port SCPI	TCP/IP socket port	
SCPI-Telnet Port	SCPI Telnet port	
HiSLIP Port	HiSLIP port	
MAC Address	MAC address	

Change the parameter value.

Normally, set “IP Address Assign” to “AUTO” (factory default setting).

Parameter	Value ^{*1}
IP Address Assign	<u>AUTO</u> (auto), STATIC (fixed), DISABLE (disable IPv4/IPv6)
IP Address ^{*2}	0.0.0.0 to 254.254.254.254 (IPv4) 0 to 9 and a to f allowed (IPv6)
Subnet Mask ^{*2*3}	0.0.0.0 to 255.255.255.255
Subnet Prefix Length ^{*2*4}	16 to 112
Default Gateway ^{*2}	0.0.0.0 to 254.254.254.254 (IPv4) 0 to 9 and a to f allowed (IPv6)
Primary DNS ^{*2}	0.0.0.0 to 254.254.254.254 (IPv4) 0 to 9 and a to f allowed (IPv6)
Secondary DNS ^{*2}	0.0.0.0 to 254.254.254.254 (IPv4) 0 to 9 and a to f allowed (IPv6)
Primary WINS ^{*2*3}	0.0.0.0 to 254.254.254.254
Secondary WINS ^{*2*3}	0.0.0.0 to 254.254.254.254
Hostname	Enter the host name (up to 15 characters). Factory default is model name and serial number.
Description	Enter the service name (up to 63 characters). The factory default setting is KIKUSUI XXXX AC Power Supply (where XXXX is the model name) and serial number
mDNS	<u>Enable/Disable</u>
Dynamic DNS	<u>Enable/Disable</u>
NetBbIOS Over TCP/IP ^{*3}	<u>Enable/Disable</u>

^{*1}. Factory default settings are underlined.

^{*2}. Can be set when the IP address assignment method is Static.

^{*3}. IPv4 only.

^{*4}. IPv6 only.

1 For IPv4, press **CONFIG (SHIFT+OPR MODE) > COM-I/F (F1) > LAN (F1)**. For IPv6, press **CONFIG (SHIFT+OPR MODE) > COM-I/F (F1) > LAN (F1) > IPv6 (F6)**.

The present settings are displayed.

2 Press **MODIFY (F3)**.

3 Select the parameter you want to change, press **EDIT (F3)**, and change the value.

For parameters other than the IP address assignment method, multicast DNS, dynamic DNS, and NetBIOS Over TCP/IP, press **OK (F4)** after you set the value. You can cancel a setting by pressing **CANCEL (F6)**.

4 When you are finished with the settings, press **APPLY (F5)**.

To cancel, press **CANCEL (F6)**.

5 Turn the **PCR-WEA's POWER** switch off and then back on.

The settings take effect.

 **WARNING**

Possible damage to the equipment and electric shock. The LAN interface can be accessed from anywhere on the network that the product is connected to. Change the security settings if necessary. The security settings that you can apply are: password protection and IP address access control.

■ **Service request**

The product is equipped with service request and serial polling functions.

■ LAN function

Depending on the operations that you perform through your Web browser, the product may need to connect to the Internet.

Complies with LXI 1.5 Device Specification 2016

Complies with the SCPI-Telnet, VXI-11, HiSLIP, and SCPI-RAW protocols

Baud rate: 100 Mbps maximum (auto negotiation)

AUTO MDIX

Web browser interface features

- Displays measuring instrument information, network information, VISA resource information, system information, license information

- Change network settings, configure security settings, set passwords

- Use the simple power supply control application

■ Resetting the LAN settings

You can return all LAN settings except the host name and service name to their factory default settings.

1 Press **CONFIG (SHIFT+OPR MODE) > COM-I/F (F1) > LAN (F1) > RESET (F4)**.

Pressing CONFIG (SHIFT+OPR MODE) > COM-I/F (F1) > LAN (F1) > IPv6 (F6) > RESET (F4) performs the same operation.

A confirmation screen appears.

2 Press **OK (F4)**.

The interface setting is reset.

To cancel, press CANCEL (F5).

■ Returning the LAN settings to their factory default settings

You can return the LAN settings to their factory default settings.

1

Press CONFIG (SHIFT+OPR MODE) > COM-I/F (F1) > LAN (F1) > DEFAULT (F4).

Pressing CONFIG (SHIFT+OPR MODE) > COM-I/F (F1) > LAN (F1) > IPv6 (F6) > DEFAULT (F4) performs the same operation.

A confirmation screen appears.

2

Press OK (F4).

The interface settings are returned to the factory default values.

To cancel, press CANCEL (F5).

■ When using SCPI-Telnet or SCPI-RAW

If you send consecutive setting commands at a high speed, the product reception buffer may overflow. Either do not send consecutive commands—send query commands and read the responses at fixed intervals—or reduce the command transmission frequency. If an error (-363 Input buffer overrun) occurs, close VISA once, and then open it again to reconnect.

Accessing and Operating the Product from a Web Browser (LAN)

You can configure the LAN interface settings from your PC's Web browser. Use the latest browser version. (Recommended browser: Internet Explorer11, Chrome, Safari)

The website URL is the product's IP address with http:// added in front of it.

If a VISA library is in use, a function for searching the VXI-11 measurement instrument with the application supplied by the vendor (National Instruments NI-MAX, Keysight Connection Expert, Kikusui KI-VISA Instrument Explorer, or the like) is available. You can open the Web browser interface by simply searching for the instrument and clicking the Web link that appears in the search result.

Example: When the IP address is 169.254.7.8

`http://169.254.7.8`

Welcome page

When you connect to the Web browser interface, a WELCOME page appears first.

This page shows the measuring instrument information, network information, and VISA resource (I/O resource) information. Click the navigation menu to go to another page.

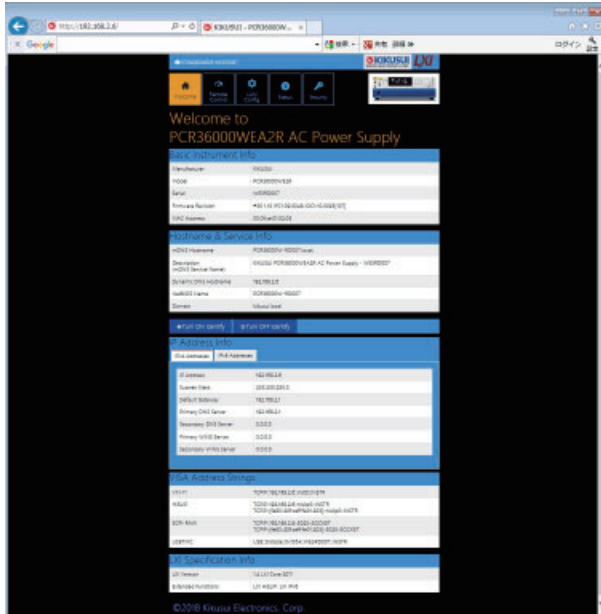

The screenshot shows a web browser window displaying the welcome page for a Kikusui PCR36000WEA2R AC Power Supply. The page is organized into several sections with blue headers:

- Product Information:** A table listing details such as Manufacturer (KIKUSUI), Model (PCR36000WEA2R), Serial (40999207), Firmware Revision (4.02.01), and MAC Address (00:0A:8C:00:00:00).
- Measuring Instrument Info:** A table providing technical specifications like Model Name (PCR36000-WEA2R), Description (PCR36000WEA2R AC Power Supply - V900007), Output Voltage (18.750V), and Output Current (6.000A).
- Network Info:** A table showing IP address (192.168.1.4), Subnet Mask (255.255.255.0), Default Gateway (192.168.1.1), and DNS Server (192.168.1.1).
- VISA Address Strings:** A table listing VISA, GPIB, and LAN addresses for both the device and the host.
- I/O Specification Info:** A table showing I/O Device (14.000) and I/O Resource (192.168.1.4).

At the bottom of the page, it states "©2019 Kikusui Electronics, Corp."

Remote Control page

You can remotely control the PCR-WEA from a browser. The various buttons have the same functions as those on the front panel of the PCR-WEA.

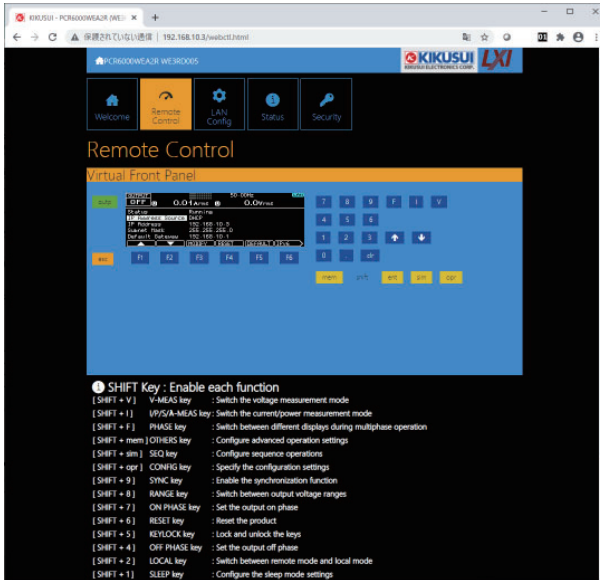

SHIFT Key

Clicking SHIFT and then a button enables the displayed function.

■ LAN Configuration page

You can display (View Mode) and change (Modify Mode) the network settings.

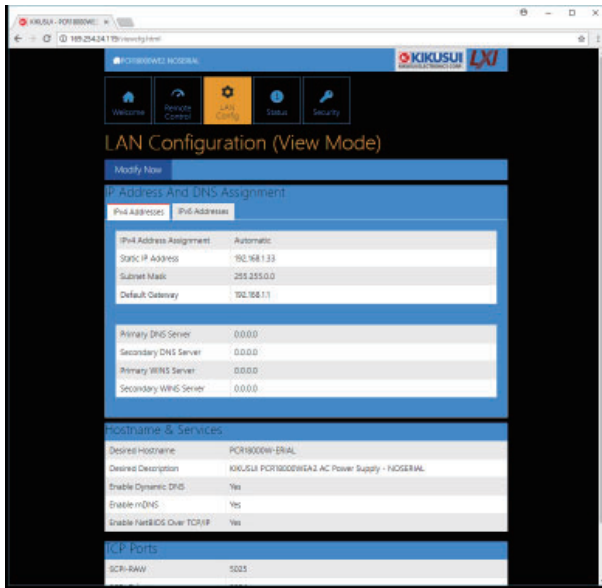

Navigation (View Mode)

Modify Now: Changes to the network setting edit screen (Modify Mode).

Navigation (Modify Mode)

Undo: Returns the edited contents to the state before editing.

Apply: Applies the edited contents.

Reset: Resets the network settings.

Default: Returns the network settings to the factory default settings.

Back to View Mode: Changes to the network setting view screen (View Mode).

IP Address Assignment

You can set the IP address. You can choose between automatic assignment and assignment of a fixed address.

In the case of automatic assignment of IP address, we recommend using the DHCP server function using a router as far as possible.

If the DHCP server function is not used, it takes about 60 seconds until determination that address assignment with DHCP has failed. Then, an address between 169.254.0.0 to 169.254.255.255 is assigned by link local address (Auto-IP).

DNS Server Assignment

Sets the address of the DNS server.

WINS Server Assignment

Sets the address of the WINS server.

Hostname & Services

You can set the host name and so on. If you set the host name, you can use it in place of the IP address to access the LAN interface. Normally, we recommend that you select "Enable Dynamic DNS", "Enable mDNS", and "Enable NetBIOS Over TCP/IP".

If you leave the Hostname and Description boxes empty and click "Apply," the host name will be created from the model name and serial number.

TCP Ports (View Mode)

The number of the TCP port in use is displayed. You cannot change the port number.

Reset and factory default settings

If you click Reset or Default, network settings are changed as follows.

The items with an X mark are returned to their default values.

Reset	Default	Parameter	Default value
X	X	Assignment Method	DHCP:ON, Auto-IP:ON, Static:OFF
X	X	DNS Server Assignment	0.0.0.0
X	X	WINS Server Assignment	0.0.0.0
—	X	Desired Hostname	<Model name> - <Last 5 digits of serial number>
—	X	Desired Description	KIKUSUI <model name> AC Power Supply - <serial number>
X	X	Enable Dynamic DNS	Enable
X	X	Enable mDNS	Enable
X	X	Enable NetBIOS Over TCP/IP	Enable

■ System Status page

This page shows the system information and the license information of the open-source software.

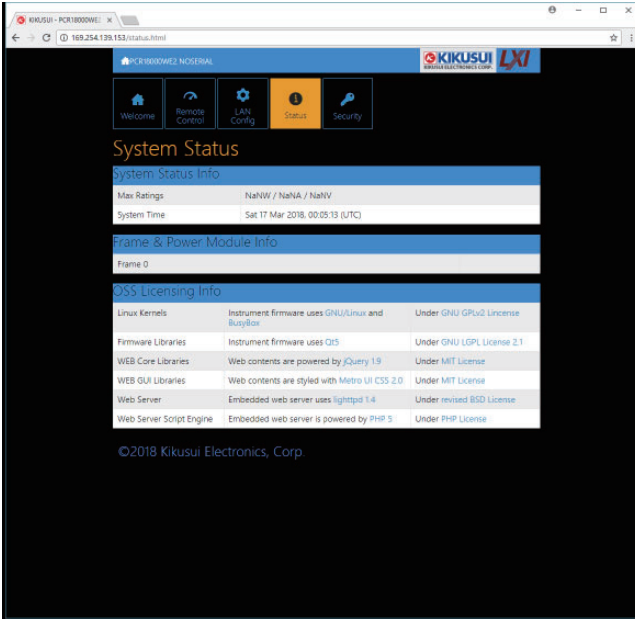

The screenshot shows a web browser window displaying the Kikusui PCR1800WE2 NO SERIAL interface. The page title is "System Status". The navigation menu includes Welcome, Remote Control, LAN Config, Status (highlighted), and Security. The main content area is divided into three sections:

System Status Info

Max Ratings	NaNW / NaNV / NaNV
System Time	Sat 17 Mar 2018, 00:05:13 (UTC)

Frame & Power Module Info

Frame 0	
---------	--

OSS Licensing Info

Linux Kernels	Instrument firmware uses GNU/Linux and Busybox	Under GNU GPLv2 License
Firmware Libraries	Instrument firmware uses Qt5	Under GNU LGPL License 2.1
WEB Core Libraries	Web contents are powered by jQuery 1.9	Under MIT License
WEB GUI Libraries	Web contents are styled with Metro UI CSS 2.0	Under MIT License
Web Server	Embedded web server uses lighttpd 1.4	Under revised BSD License
Web Server Script Engine	Embedded web server is powered by PHP 5	Under PHP License

©2018 Kikusui Electronics, Corp.

■ Password Security page

You can set and change the password for the Web browser interface here.

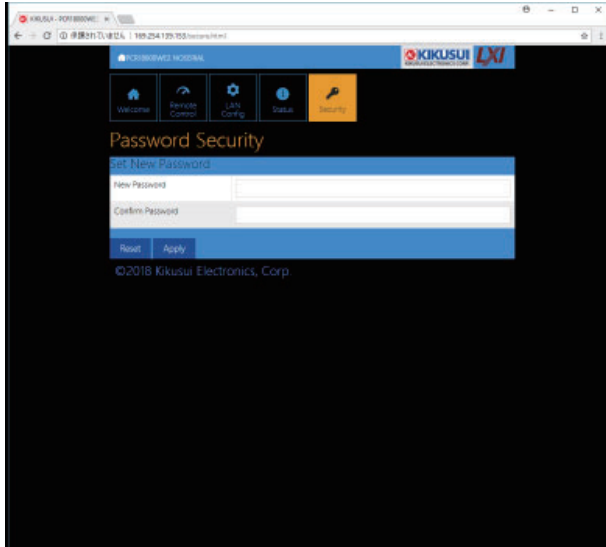

When a password has been set, that password is required in order to use the following functions.

- Remote control from Remote Control page

- Editing of LAN Configuration page

- Changing/deleting the password

Set New Password

Enter the password.

You can use alphanumeric characters, hyphens, and underscores for the password. The first character must be an alphabet. You can enter up to 15 characters.

Changing or deleting the password

After the password has been set, the screen for changing the password appears when you enter the password.

To change the password, enter the present password in “Current Password”, enter the new password in “New Password” and “Confirm Password”, and then click “Apply”.

To disable password protection, enter the present password in “Current Password”, leave “New Password” and “Confirm Password” blank, and click “Apply”.

If you forget the password

If you forget the password, reset the LAN interface setting in the CONFIG settings or initialize the product to its factory default settings.

GPIB (option)

The information in this section is valid only when the optional GPIB interface board is installed.

■ GPIB connection

Connect the product to a PC using a standard IEEE488 cable.

■ GPIB settings

- 1 Press CONFIG (SHIFT+OPR MODE) > COM-I/F (F1) > GPIB (F4).**
The present GPIB settings are displayed.
- 2 To enable GPIB, press ENABLE (F1). To disable it, press DISABLE (F2).**
- 3 Press ADDRESS (F2) to set the GPIB address.**
The factory default GPIB address is 5.
- 4 Press ESC > APPLY (F5).**
To cancel, press CANCEL (F6).
- 5 Turn the PCR-WEA's POWER switch off and then back on.**
The settings take effect.

■ GPIB function

Function	Subset	Description
Source handshaking	SH1	Full capability
Acceptor handshaking	AH1	Full capability
Talker	T8	Function available
Listener	L4	Function available
Service request	SR0	No capability
Remote local	RL0	No capability
Parallel polling	PP0	No capability
Device clear	DC0	No capability
Device trigger	DT0	No capability
Controller	C0	No capability
Electrical interface	E1	Open-collector driver

■ Functional Limitations

The following GPIB-specific functions cannot be used on the PCR-WEA/WEA2.

- Serial polling, parallel polling

- Remote local control

- Device clear

However, for serial polling and remote local control, equivalent functions can be used through similar commands.

GPIB function	Substitute command
Serial Polling	*STB?
GET (Group Execute Trigger)	*TRG
GTL (Go To Local)	SYST:COMM:RLST LOC
REN (Remort Enable)	SYST:COMM:RLST REM
LLO (Local Lock Out)	SYST:COMM:RLST RWL

About Commands

The information that is transferred between the controller (PC) and the device (PCR-WEA/WEA2 series) is referred to as messages.

This product uses the SCPI language for these messages.

The messages that the PC sends to the product are commands. The messages that the product sends to the PC are responses.

Command Hierarchy

SCPI is an ASCII-based command language that was designed for test and measuring equipment. The command structure is composed of the common roots and nodes that are the building blocks of the SCPI subsystem. A command consists of a program header, parameters, and punctuation marks.

The following table uses the SOURce subsystem as an example to explain the hierarchy.

Program header	Parameter	Node level
SOUR:		Root node
FREQ		2nd level
:LIM		3rd level
:UPP	<numeric>	4th level
:LOW	<boolean>	4th level
VOLT		2nd level
:RANGE		3rd level
:UPP	<numeric>	4th level
:AUTO	<boolean>	4th level

A colon (:) separates a higher node from a lower node.

Command Syntax

—Note—

To use the RS232C interface, a “SYSTEM:COMM:RLST REM” command must be sent to set the product to remote mode. To use remote programming, send “SYSTEM:COMM:RLST REM” at the beginning of the program.

In this manual, SCPI commands are expressed in the following format.

```
MEASure[:SCALar]:CURRent:DC? {<numeric>|MINimum|MAXimum}
```

SCPI commands are also available in the short form. In the short form, the lowercase characters in SCPI commands are omitted.

SCPI commands can be sent either in the long form or short form. Because SCPI commands are not case-sensitive, CURR, CURRent, and curr are all acceptable as short form notations. In the long form, CURRENT, Current, and current are all acceptable.

- A space separates a program header and its parameters.
- Multiple parameters are separated by commas.
- Multiple commands are separated by semicolons (compound command).

```
OUTPut:PHASe:ON:STATe ON;LEVel 90
```

In the second command, OUTPut:PHASe:ON is omitted. This is possible because that path is set to OUTPut:PHASe:ON by the first command (OUTPut:PHASe:ON:STATe ON).

This compound command is equivalent to entering the following commands.

```
OUTPut:PHASe:ON:STATe ON
```

```
OUTPut:PHASe:ON:LEVel 90
```

If you specify a node that is not defined in the current path, an error will occur.

By using colons and semicolons, you can concatenate commands of different subsystems.

```
SOURce:CURRent MINimum;MEASure:CURRent:AC?
```

There are two root nodes in this compound command: SOURce and MEASure.

When the second command or later begins with a colon, the path that was specified by the previous command is cleared.

- The maximum length of a command that you can transmit on a single line is 512

bytes.

■ Special symbols

The special symbols that are used in this manual for the SCPI command syntax are explained below.

- Characters and numbers enclosed by { and } and delimited by “|” indicate that one of the delimited items is to be selected.

Do not include the { and } symbols in the actual program.

- <> denotes program data.

Do not include the < and > symbols in the actual program.

- [] denotes optional data.

When optional data is not sent with the program, the default value is applied.

Do not include the [and] symbols in the actual program.

■ Query

You can query the device settings and status.

To make a query, append a question mark to the end of the program header section.

If the query has parameters, insert a space after the question mark, and then write the parameters.

```
CURRent? MIN
```

Response

This is the response to a query. It is a message always sent from the device to the host PC. It conveys device status or measured value to the PC.

—Note—

If you want to send two queries on separate lines, send the second query after you have received the response to the first one.

■ Program terminator

All commands must be terminated with a valid terminator.

	RS232C	USB	LAN	
			VXI-11, HiSLIP	SCPI-RAW
Receiving	LF	LF or EOM	LF or END	LF
Sending	LF	LF+EOM	LF+END	LF

When you terminate a command string, the path is reset to the root level.

—Note—

CR (ASCII 0x0D) is not a terminator.

■ Common Commands

There are commands that are common to the IEEE-488.2 and SCPI standards for functions such as resetting devices and performing self-diagnoses. These common commands start with an asterisk (“*”). These commands may have one or multiple parameters.

Parameters

The SCPI parameter format is derived from the program parameter format that is defined in IEEE 488.2.

The program data expression format that the this product uses is shown below.

Non-numeric parameters

String data (String)

String data is used when a series of ASCII characters (20H to 7EH) are requested.

Enclose strings in single (' ') or double quotation (" ") marks. The opening and closing quotation marks must match (you cannot mix single and double quotation marks).

```
SYSTem:TZONe "Asia/Tokyo"
```

If you want to include a quotation mark as part of the string, enter consecutive quotation marks (with no characters between them).

Character data (Character)

Character data is used when only a limited number of values are available for a program setting. Responses are returned in short form.

```
TRIGger:SOURce {BUS|IMMediate}
```

Boolean data (Boolean)

Boolean data is used to express a condition of 1 or 0, or ON or OFF. Responses are returned as 1 or 0.

```
OUTPut {ON|OFF|1|0}
```

Block data (block)

Arbitrary block data that starts with #.

WAVE:DATA:ARB 5, #481927FFF8000...7FFF8000

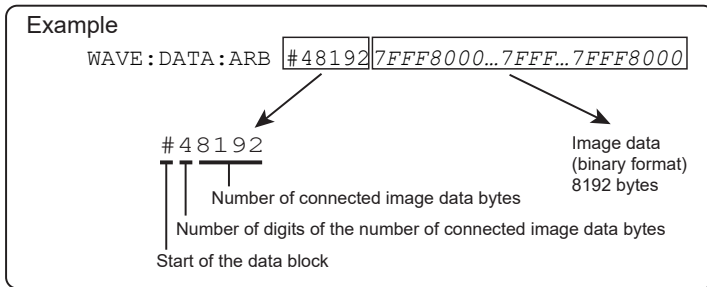

Numeric parameters

NR1

Represents an integer value.

Details are given in the “IEEE 488.2 Standard Digital Interface for Programmable Instrumentation.”

NR2

Represents a real number in floating-point format.

Details are given in the “IEEE 488.2 Standard Digital Interface for Programmable Instrumentation.”

NR3

Represents a real number in scientific notation.

Details are given in the “IEEE 488.2 Standard Digital Interface for Programmable Instrumentation.”

If 380 is returned in the response data, it is returned as +3.80000E+02. Five decimal places are used.

NRf

NRf is a generic term that includes NR1, NR2, and NR3.

Numeric

Numeric parameter for values such as the decimal point, optional prefixes, and measurement units.

Numbers are expressed the same as NRf.

MINimum, MAXimum, and the like are available as substitutes for declaring certain values.

You can also use units such as V, A, and W in numeric parameters.

Special form numeric parameters

The special form numeric parameters MINimum and MAXimum can be used as substitutes for the actual maximum and minimum values when the parameter is numeric.

The following example sets the overcurrent protection value to the minimum value.

```
SOURce:CURRent MINimum
```

You can query the minimum and maximum values for most parameters.

```
SOURce:CURRent? MAX
```

```
SOURce:CURRent? MIN
```

Phase designation (channel list)

When the parameter is numeric, this product allows you to designate the phases you want to set using the syntax (@chanlist). The INSTRUMENT command settings do not apply to phase-designated commands.

U phase is (@1), V phase (@2), and W phase (@3).

In the following example, the V phase is set to 130 V.

```
VOLT 130, (@2)
```

Multiple phases can be designated at once. To designate U phase (@1) and W phase (@3)

```
VOLT 130, (@1, 3)
```

To designate all phases (@1 to @3)

```
VOLT 130, (@1:3)
```

Measurement units

The default measurement units are listed below. Commands are accepted even if measurement units are not specified.

- V (voltage)
- VAR (reactive power)
- HR (hours)
- OHM (resistance)
- A (current)
- DEG (degrees)
- MIN (minutes)
- W (power)
- HZ (frequency)
- S (seconds)
- VA (apparent power)
- H (reactance)
- PCT (%)

The following optional prefixes are supported. If you use optional prefixes, specify the measurement unit.

- M (milli)
- K (kilo)
- U (micro)

—Note—

- The unit symbols in the International System of Units contain lowercase characters. The IEEE standard uses uppercase characters. SCPI commands are not case sensitive.
- Commands are accepted whether or not measurement units are specified.
- To enter “ μ ” in the data, use “U” instead.

IEEE 488.2 common commands

*CLS

Clears all event registers including the status byte, event status, and error queue.

Clears the operation complete standby that was created by the *OPC or *OPC? command.

Command

*CLS

*ESE

Sets the event status enable register that is counted by the event summary bit (ESB) of the status byte.

Command

```
*ESE <NRf>
```

```
*ESE?
```

Parameter

Value: 0 to 255

Example: When *ESE 16 is transmitted, bit 4 of the event status enable register is set. Each time the execution error bit (bit 4) of the event status register is set, the summary bit (ESB) of the status byte is set.

Response: NR1

*ESR

Queries the event status register. The event status register is cleared when read.

Command

*ESR?

Response: NR1

***IDN**

Queries the model name and firmware version of the product.

Command

*IDN?

Response

The response to *IDN? is indicated below.

Response example for model PCR3000WEA2, serial number WE3RD008, firmware version 1.00 IFC0.03.0035 IOC0.05.0079

```
KIKUSUI,PCR3000WEA2,WE3RD008,1.00 IFC0.03.0035 IOC0.05.0079
```

is returned.

*OPC

Sets the OPC bit (bit 0) of the event status register when all the commands that are in standby have been processed.

See IEEE 488.2-1992 section 12.5.3.

Command

*OPC

*OPC?

Response

Returns "1" when all the commands that are in standby have been processed.

***OPT**

Queries the optional interface boards that are installed in the product.

During parallel operation, queries the optional interface boards that are installed in the master unit.

Command

*OPT?

Response

Returns the installed options in comma-separated string format. Returns "0" if no options are installed.

"GPIB"	IB07-PCR-WE GPIB interface board
"EXT-MON"	Analog monitor output option model
"500HZLMT"	500 Hz limit model

*PSC

Sets whether the event status enable register and service request enable register are cleared when the POWER switch is turned on.

Command

```
*PSC <boolean>
```

```
*PSC?
```

Parameter <boolean>

Value: ON(1) When the POWER switch is turned on, the *ESE and *SRE settings are cleared.

OFF(0) When the POWER switch is turned on, the *ESE and *SRE settings are not cleared.

Example

```
*PSC 0
```

Response: NR1

***RCL**

Recalls memory content.

Clears alarms.

Aborts the trigger subsystem operation.

Command

```
*RCL <NRf>
```

Parameter

Value: 0 to 9 memory number

Example

```
*RCL 1
```

*RST

Resets a portion of the product settings.

Clears alarms. Aborts the trigger subsystem operation.

Clears *OPC and *OPC?. Clears the contents of the preset memory.

Command	Value when *RST is transmitted
DISP:PHAS	0
DISP:MMOD:CURR	RMS
DISP:MMOD:VOLT	RMS
DISP:MMOD:VOLT:LTL	OFF
INST	OUTP1
INST:NSEL	1
INST:COUP	ALL
OUTP	OFF
OUTP:IMP	OFF
OUTP:IMP:REAC	0
OUTP:IMP:REAL	0
OUTP:PHAS:OFF	OFF
OUTP:PHAS:OFF:LEV	0
OUTP:PHAS:ON	OFF
OUTP:PHAS:ON:LEV	0
OUTP:PON	SAFE
OUTP:SST	OFF
OUTP:SST:FALL	OFF
OUTP:SST:TIME	0.1
OUTP:SST:TIME:FALL	0.1
SENS:AVER:COUN	1
SENS:CURR:HOLD:TIME	1
SENS:VOLT:AVER:COUN	1
SENS:VOLT:HOLD:TIME	1
CURR	MAXimum
CURR:PEAK	MAXimum
CURR:PEAK:LOW	MAXimum
CURR:PROT:STAT	ON
CURR:PROT:TRIP:DEL	10
FREQ	50
FREQ:LIM:LOW	1
FREQ:LIM:UPP	5000 (500 on the 500 Hz LMT model)
REQ:SYNC	OFF
FREQ:SYNC:MODE	LINE
FREQ:SYNC:PHAS:DEL	0
FREQ:TRIG	50
FUNC:BANK	0
ROSC	INTernal
VOLT	0
VOLT:COMP:MODE	DISabled

Command	Value when *RST is transmitted
VOLT:COMP:RADJ	0
VOLT:COMP:SOFT:CONT	AC
VOLT:COMP:SOFT:TERM	SENS
VOLT:EXT:INP:EXTDC:ADJ:GAIN	100 (all channels)
VOLT:EXT:INP:EXTDC:ADJ:OFFS	0 (all channels)
VOLT:EXT:INP:EXTDC:APER	0.1
VOLT:EXT:INP:EXTDC:SIGN:POL	NORMal
VOLT:EXT:INP:EXTDC:SIGN:SOUR	EXTErnal
VOLT:EXT:INP:FUNC:MODE	OFF
VOLT:EXT:INP:VPR:ADJ:GAIN	10 (all channels)
VOLT:EXT:INP:VPR:ADJ:OFFS	0 (all channels)
VOLT:EXT:INP:VPR:MAP	ALL
VOLT:EXT:INP:VPR:STAT	OFF
VOLT:LIM:LOW	0
VOLT:LIM:UPP	322
VOLT:LTL	0
VOLT:OFFS	0
VOLT:OFFS:LIM:LOW	-455
VOLT:OFFS:LIM:UPP	455
VOLT:OFFS:LTL	0
VOLT:OFFS:TRG	0
VOLT:PROT:LOW	0
VOLT:PROT:PEAK:LOW	-500.5
VOLT:PROT:PEAK:UPP	500.5
VOLT:PROT:LOW:STAT	OFF
VOLT:PROT:UPP	500.5
VOLT:RANG	161
VOLT:RESP	MEDium
VOLT:TRIG	0
SYST:CONF:ACC	OFF
SYST:CONF:FORM:PSAV:MAX	Rated power
SYST:CONF:PHAS:UOFF	0
SYST:CONF:PHAS:UV	120 (180 at two-phase output)
SYST:CONF:PHAS:UW	240
SYST:EXT:MON:OUTP:ADJ:FMON:GAIN	10 (all channels)
SYST:EXT:MON:OUTP:ADJ:FMON:OFFS	0 (all channels)
SYST:EXT:MON:OUTP:ADJ:IMON:GAIN	PCR1000WEA: 1, PCR2000WEA: 2 PCR3000WEA2: 3, PCR6000WEA2: 10 PCR12000WEA2: 20, PCR18000WEA2: 30 PCR24000WEA2: 40, PCR30000WEA2: 50 PCR36000WEA2: 60 (all channels)
SYST:EXT:MON:OUTP:ADJ:IMON:OFFS	0 (all channels)

Command	Value when *RST is transmitted
SYST:EXT:MON:OUTP:ADJ:PMON:GAIN	PCR1000WEA: 100, PCR2000WEA: 200 PCR3000WEA2: 300, PCR6000WEA2: 1000 PCR12000WEA2: 2000, PCR18000WEA2: 3000 PCR24000WEA2: 4000, PCR30000WEA2: 5000 PCR36000WEA2: 6000 (all channels)
SYST:EXT:MON:OUTP:ADJ:PMON:OFF	0 (all channels)
SYST:EXT:MON:OUTP:ADJ:VMON:GAIN	100 (all channels)
SYST:EXT:MON:OUTP:ADJ:VMON:OFFS	0 (all channels)
SYST:EXT:MON:OUTP:MAP	Ch.A: VOLT1_WAVE Ch.B: CURR1_WAVE Ch.C: POW1_WAVE
SYST:EXT:MON:OUTP:STAT	DISable (all channels)
SYST:SLE	OFF
SYST:SLE:TIME	3600
TRIG:ACQ:SOUR	IMMediate
TRIG:PROG:SOUR	IMMediate
TRIG:SIM:SOUR	IMMediate
TRIG:TRAN:SOUR	IMMediate

Command

*RST

***SAV**

Saves the panel settings to memory.

Command

```
*SAV <NRf>
```

Parameter

Value: 0 to 9 memory number

Example

```
*SAV 1
```

*SRE

Sets the service request enable register.

The service request enable register can be used to select which summary messages in the status byte register will perform service requests.

To clear the service request enable register, send *SRE 0. If the register is cleared, service requests cannot be generated using status information.

Command

*SRE <NRf>

*SRE?

Parameter

Value: 0 to 255

Example: Sending *SRE8 sets bit 3 of the service request enable register. Each time the summary bit (bit 3) of the QUEStionable status register in the status byte is set, a service request message is generated.

Response: NR1

***STB**

Queries the contents of the status byte register and the MSS (master summary status) message.

The response is the same as serial polling only with the exception that the MSS message appears in place of the RQS message in bit 6.

Command

*STB?

Response: NR1

*TRG

Trigger command.

Executes triggers on the TRANSient trigger group and ACQUIRE trigger group.

This is a substitute command for IEEE 488.1 get (Group Execute Trigger).

If the device is in a state in which it does not accept triggers, an SCPI error (-211, "Trigger ignored") occurs.

See IEEE 488.2-1992 section 10.37.

Command

*TRG

***TST**

Executes a self-test.

You can check which error occurred with SYST:ERR? command. See IEEE 488.2-1992 section 10.38.

Command

*TST?

Response

Returns +0 if there are no errors. Returns an error code if there is a problem.

*WAI

Prevents the device from executing subsequent commands until all operations that are in standby have completed.

Command

*WAI

ABORt Command

This product has four different trigger subsystems (TRANsient, ACQuire, SIMulation, PROGram).

TRANsient is a subsystem for changing settings.

ACQuire is a measurement trigger subsystem. This subsystem is used to measure voltage, current, and power.

SIMulation executes power line abnormality simulations.

PROGram runs sequences.

ABOR

Aborts configuration, changes, measurements, and other operations in all trigger subsystems (TRANsient, ACQuire, SIMulation, PROGram).

The product's trigger state immediately after it turns on is the same as its trigger state after it receives an ABOR command.

If you send an ABOR command while the PCR is executing measurements, the measured data is discarded.

You cannot specify a trigger subsystem with the ABOR command. It is always interpreted as ALL.

Command

```
ABORt [:ALL]
```

ABOR:ACQ

Aborts measurement operations.

If you send an ABOR command without initiating, the measured data is not discarded.

Command

ABORt:ACQuire

ABOR:PROG

Stops the trigger function of the sequence operation.

Command

ABORt:PROGAm

ABOR:SIM

Aborts the trigger function of the power line abnormality simulation.

Command

ABORt:SIMulation

ABOR:TRAN

Aborts the trigger function for configuration changes.

Command

```
ABORt:TRANsient
```

DISPlay Command

DISP:CONT

Adjusts the screen brightness.

Command

```
DISPlay:CONTRast <NRf>
```

```
DISPlay:CONTRast?
```

Parameter

Value: 1 to 3 (The default value is 3)

Example

```
DISP:CONT 2
```

Response: NR1

DISP:PHAS

Selects the phase to display on the panel.

This is invalid for single-phase operation.

Command

```
DISPlay:PHASe <NR1>
```

```
DISPlay:PHASe?
```

Parameter

Value:	0	All phases (default)
	1	U phase
	2	V phase
	3	W phase

Settings are reset to default values when an *RST command is sent.

Example

```
DISP:PHAS 1
```

Response: NR1

DISP:MMOD:CURR

Sets the current, power, or power factor to display on the screen.

Command

```
DISPlay:MMODe:CURRent <character>
```

```
DISPlay:MMODe:CURRent?
```

Parameter

Value:	RMS	Rms current (default)
	PEAK	Peak current
	DC	Average current
	WATTage	Power
	VA	Apparent power
	PF	Power factor
	TWATtage	Total power (single-phase three-wire output and three-phase output only)
	TVA	Total apparent power (single-phase three-wire output and three-phase output only)
	TPF	Total power factor (single-phase three-wire output and three-phase output only)

Settings are reset to default values when an *RST command is sent.

Example

```
DISP:MMOD:CURR RMS
```

Response: Characters

DISP:MMOD:VOLT

Sets the voltage (rms value, peak value, average value) to display on the screen.

Command

```
DISPlay:MMODE:VOLTage <character>
```

```
DISPlay:MMODE:VOLTage?
```

Parameter

Value:	RMS	Rms voltage (default)
	PEAK	Peak voltage
	DC	Average voltage

Settings are reset to default values when an *RST command is sent.

Example

```
DISP:MMOD:VOLT PEAK
```

Response: Characters

DISP:MMOD:VOLT:LTL

Sets the voltage (phase voltage, line voltage) to display on the screen.

This is invalid for single-phase operation.

Command

```
DISPlay:MMODe:VOLTage:LTLLine[:STATE] <boolean>
```

```
DISPlay:MMODe:VOLTage:LTLLine[:STATE]?
```

Parameter

Value:	ON(1)	Line voltage
	OFF(0)	Phase voltage (default)

Settings are reset to default values when an *RST command is sent.

Example

```
DISP:MMOD:VOLT:LTL ON
```

Response: NR1

HCOPy Command

HCOP:SDUM:DATA?

Retrieves the screen capture of the present screen.

Command

HCOPy:SDUMp:DATA?

Response: Block (length: 3 KBytes to 3.5 KBytes)

INITiate Command

This command cannot be executed simultaneously with the TRANsient, SIMulation, or PROGram subsystem.

INIT:ACQ

These commands invalidate the present measured data and start a new measurement.

When the trigger source is set to IMM, measurement is started immediately. When the trigger source is set to BUS, the device waits for a software trigger and then starts a measurement.

Command

```
INITiate[:IMMEDIATE]:ACquire
```

Related command

```
TRIG:ACQ
```

```
TRIG:ACQ:SOUR
```

INIT:PROG

Executes a sequence.

When the trigger source is set to IMM, the sequence is executed immediately. When the trigger source is set to BUS, the device waits for a software trigger and then executes the sequence.

Command

```
INITiate[:IMMediate]:PROGram
```

Related command

```
TRIG:PROG
```

```
TRIG:PROG:SOUR
```

INIT:SIM

Executes a power line abnormality simulation.

When the trigger source is set to IMM, the sequence is executed immediately. When the trigger source is set to BUS, the device waits for a software trigger and then executes the sequence.

This is invalid when the output is off.

This is invalid if the DC voltage is not zero.

This is invalid when the T3 voltage is set in the H range area or when the present voltage range is L.

Command

```
INITiate[:IMMEDIATE]:SIMulation
```

Related command

```
TRIG:SIM
```

```
TRIG:SIM:SOUR
```

INIT:TRAN

Starts the trigger function.

If the trigger source is set to IMM, change is immediately started. When the trigger source is set to BUS, the device waits for a software trigger and then starts the change.

Command

```
INITiate[:IMMediate]:TRANsient
```

Related command

```
TRIG:TRAN
```

```
TRIG:TRAN:SOUR
```

INSTrument Command

This command selects the phase that SOURce and MEASure/FETCh commands apply to for single-phase three-wire output or three-phase output. The INSTrument command designation does not apply to phase-designated commands.

In the factory default condition, at power-on, and after a *RST or *RCL is sent, all phases are selected (INST:COUP ALL).

INST/ INST:NSEL

Selects the phase that SOURce and MEASure/FETCh commands apply to.

This does not apply to phase-designated commands.

This is invalid when INST:COUP is set to ALL.

Command

```
INSTrument[:SElect] <character>
```

```
INSTrument[:SElect]?
```

```
INSTrument:NSElect <NRf>
```

```
INSTrument:NSElect?
```

Parameter INST command

Value:	OUTPut1	U phase (default)
	OUTPut2	V phase
	OUTPut3	W phase

Parameter INST:NSEL command

Value:	1	U phase (default)
	2	V phase
	3	W phase

Settings are reset to default values when an *RST command is sent.

Example

```
INST OUTP1
```

Response

Returns the designated phase in character format in response to INST?.

Returns the designated phase in NR1 format in response to INST:NSEL?.

INST:COUP

Sets whether to select all phases.

This is invalid for single-phase output.

Command

```
INSTRument:COUPle <character>
```

```
INSTRument:COUPle?
```

Parameter

Value:	NONE	None of the phases are selected.
	ALL	All phases are selected (default).

Settings are reset to default values when an *RST command is sent.

Example

```
INST:COUP ALL
```

Response: Characters

LXI Command

LXI:IDEN

Turns the identification display on or off.

When turned on, the LAN indicator blinks in the upper right of the front panel display of the PCR-WEA that is being controlled through the LAN interface.

Command

```
LXI:IDENtify[:STATe] <boolean>
```

```
LXI:IDENtify[:STATe]?
```

Parameter

Value:	ON(1)	LAN blinking
	OFF(0)	LAN lit (Default)

Example

```
LXI:IDEN ON
```

Response: NR1

MEASure/FETCH Command

The measurement function is mapped to the ACQUIRE trigger subsystem.

If you use the root node MEASure, the measurement is performed, and then the measured value is queried. If you use FETC, the measured value is queried without a measurement being performed.

<meas-item>/<harm-item> is the last node of the command header.

->[Tutorial "Measurement \(ACQUIRE\)"](#)(p. 337)

FETC:<meas-item>/ MEAS:<meas-item>

Queries the scalar measurement data specified with <meas-item>.

Command

```
FETCh[:SCALar]:<meas-item>? [(@chanlist)]
```

```
MEASure[:SCALar]:<meas-item>? [(@chanlist)]
```

Measurement <meas-item> list of each phase

Phase designation (@chanlist) possible

<meas-item>	Description	Unit
ALL	All (the 25 items below)	
CURRent:AC	Rms current without a DC component	Arms
CURRent:ACDC	Rms current	Arms
CURRent:AMPLitude:MAXimum	Current peak value	A
CURRent:AMPLitude:MAXimum:HOLD	Hold value of peak current	A
CURRent:CREStfactor	Current crest factor	—
CURRent[:DC]	Average current	A
CURRent:HARMonic:THD	Total current harmonic distortion	PCT
FREQ	Frequency	HZ
POWer[:DC]	Average power	W
POWer:AC[:REAL]	Power without a DC component	W
POWer:AC:APParent	Apparent power without a DC component	VA
POWer:AC:REACTive	Reactive power without a DC component	VAR
POWer:AC:PFACTOR	Power factor without a DC component	—
POWer:ACDC[:REAL]	Power	W
POWer:ACDC:APParent	Apparent power	VA
POWer:ACDC:REACTive	Reactive power	VAR
POWer:ACDC:PFACTOR	Power factor	—
VOLTage[:DC]	Average voltage	V
VOLTage:AC	Rms voltage without a DC component	Vrms
VOLTage:ACDC	Rms voltage	Vrms
VOLTage:AMPLitude:MAXimum	Voltage peak value	V
VOLTage:AMPLitude:MAXimum:HOLD	Hold value of peak voltage	V
VOLTage:HARMonic:THD	Total voltage harmonic distortion	PCT
LTLVoltage:DC	Average line voltage	V
LTLVoltage:AC	Rms line voltage without a DC component	Vrms
LTLVoltage:ACDC	Rms line voltage	Vrms
LTLVoltage:AMPLitude:MAXimum	Line voltage peak value	V

Measurement <meas-item> list of the total values of all phases

Phase designation (@chanlist) not possible

<meas-item>	Description	Unit
POWER[:DC]:TOTal	Total average power	W
POWER:AC[:REAL]:TOTal	Total power without a DC component	W
POWER:AC:APParent:TOTal	Total apparent power without a DC component	VA
POWER:AC:REACTIVE:TOTal	Total reactive power without a DC component	VAR
POWER:AC:PFACTOR:TOTal	Total power factor without a DC component	—
POWER:ACDC[:REAL]:TOTal	Total power	W
POWER:ACDC:APParent:TOTal	Total apparent power	VA
POWER:ACDC:REACTIVE:TOTal	Total reactive power	VAR
POWER:ACDC:PFACTOR:TOTal	Total power factor	—

Response

Returns the measurement of the designated phase in NR3[,<NR3>...] format in response to FETC:<meas-item>? [(@chanlist)]/ MEAS:<meas-item>? [(@chanlist)].

Returns the measurement of the phase designated by the INST command in NR3[,<NR3>...] format in response to FETC:<meas-item>?/ MEAS:<meas-item>?.

Returns 0 in response to a line voltage query during single-phase output.

Returns the measured values in the <meas-item> list order in comma-separated NR3 format in response to FETC:ALL?/MEAS:ALL?. If you specify several phases, the measured values of the first specified phase are returned in the <meas-item> list order. Then, the measured values of the next specified phase are returned in the <meas-item> list order.

Example

```
INST:NSEL 1;COUP NONE
```

```
FETC:CURREN?           Returns the average current of the U phase.
```

```
INST:COUP ALL
```

```
FETC:CURREN?           Returns the average currents of all phases.
```

```
FETC:CURREN? (@2)      Returns the average current of the V phase.
```

```
FETC:CURREN? (@1:3)    Returns the average currents of all phases.
```

```
FETC:ALL? (@1)         Returns all scalar measurements (25 items, excluding the total value) of the U phase.
```

```
FETC:ALL?              Returns all scalar measurements (25 items × 3, excluding the total value) of all phases.
```

FETC:ARR:<harm-item>?/ MEAS:ARR:<harm-item>?

Queries the harmonic data specified with <harm-item>.

Command

FETCh:ARRay:<harm-item>? [(@chanlist)]

MEASure:ARRay:<harm-item>? [(@chanlist)]

Measurement <harm-item> list of each phase

Phase designation (@chanlist) possible

0th to 50th

<harm-item>	Description	Unit
CURRent:HARMonic:AMPLitude]	Harmonic current	Arms
CURRent:HARMonic:PHASe	Harmonic current phase	Deg
VOLTage:HARMonic:AMPLitude]	Harmonic voltage	Vrms
VOLTage:HARMonic:PHASe	Harmonic voltage phase	Deg

Response

Returns the measurements (0th to 50th) of the designated phase in a comma-separated NR3 format in response to FETC:ARR:<harm-item>? [(@chanlist)] / MEAS:ARR:<harm-item>? [(@chanlist)].

Returns the measurements (0th to 50th) of the phase designated by the INST command in a comma-separated NR3 format in response to FETC:<meas-item>? / MEAS:<meas-item>?.

Returns the measurements (0th to 50th) of the U phase in a comma-separated NR3 format when multiple phases are designated. Then, the V-phase measurements and W-phase measurements are returned in the same manner.

Example

INST:NSEL 1;COUP NONE

FETC:ARR:CURR:HARM? Returns the harmonic current of the U phase.

FETC:ARR:CURR:HARM? (@2) Returns the harmonic current of the V phase.

FETC:ARR:CURR:HARM? (@1:3) Returns the harmonic currents of all phases.

MEMory Command

MEM:REC

Recalls contents saved in the ABC memory.

You can view the contents that are stored in memory by using the MEM:REC:PREV command.

Command

```
MEMory:RECall[:IMMediate] <NRf>
```

Parameter

Value:	1	Memory A
	2	Memory B
	3	Memory C

MEM:REC:CONF

Sets whether the memory content is to be confirmed before recalling the ABC memory from the panel.

Command

```
MEMory:RECall:CONFirmation[:STATE] <boolean>
```

```
MEMory:RECall:CONFirmation[:STATE]?
```

Parameter

Value:	ON(1)	The memory content is to be confirmed (default).
	OFF(0)	The memory content is not to be confirmed.

Example

```
MEM:REC:CONF ON
```

Response: NR1

MEM:REC:PREV

Displays the contents that are stored in the ABC memory.

Command

```
MEMory:RECall:PREView? <NRf>
```

Parameter

Value:	1	Memory A
	2	Memory B
	3	Memory C

Response

Returns the following items that are stored in the specified ABC memory. The items are returned in order in a comma-separated format.

For single-phase output, AC voltage <NR3>, DC voltage <NR3>, frequency <NR3>, waveform bank number <NR1>

For single-phase three-wire output, U phase AC voltage<NR3>, V phase AC voltage<NR3>, U phase DC voltage<NR3>, V phase DC voltage<NR3>, frequency<NR3>, U phase waveform bank number<NR1>, V phase waveform bank number<NR1>

For three-phase output, U phase AC voltage<NR3>, V phase AC voltage<NR3>, W phase AC voltage<NR3>, U phase DC voltage<NR3>, V phase DC voltage<NR3>, W phase DC voltage<NR3>, frequency<NR3>, U phase waveform bank number<NR1>, V phase waveform bank number<NR1>, W phase waveform bank number<NR1>

MEM:SAVE

Saves the frequency, AC voltage, DC voltage, and waveform bank number to memory.

Command

```
MEMory:SAVE[:IMMediate] <NRf>
```

Parameter

Value:	1	Memory A
	2	Memory B
	3	Memory C

OUTPut Command

OUTP

Set the output to on or off.

This command is invalid when a protection is activated, a simulation is running, or a sequence is running.

Command

```
OUTPut[:STATe] <boolean>
```

```
OUTPut[:STATe]?
```

Parameter

Value:	ON(1)	Output on
	OFF(0)	Output off (default)

Settings are reset to default values when an *RST command is sent.

Example

```
OUTP 1
```

Response: NR1

OUTP:IMP

Enables or disables the output impedance.

Use OUTP:IMP:REAL or OUTP:IMP:REAC to set the output impedance.

Command

```
OUTPut:IMPedance[:STATe] <boolean>
```

```
OUTPut:IMPedance[:STATe]?
```

Parameter

Value: ON(1) Enables the output impedance
OFF(0) Disables the output impedance (default)

Settings are reset to default values when an *RST command is sent.

Example

```
OUTP:IMP ON
```

Response: NR1

OUTP:IMP:REAC

Sets the reactance component of the output impedances.

This command is valid when the output impedance is on (OUTP:IMP ON).

Command

```
OUTPut:IMPedance:REACtive <numeric>[, (@chanlist)]
```

```
OUTPut:IMPedance:REACtive? [ (@chanlist)]
```

Parameter

Value: Reactance component (The default value is 0.)

Response: FAST

	L range		H range	
	Single-phase	Single-phase three-wire, Three phase	Single-phase	Single-phase three-wire, Three phase
PCR1000WEA	40 μ H to 2000 μ H	--	160 μ H to 8000 μ H	--
PCR2000WEA	20 μ H to 1000 μ H	--	80 μ H to 4000 μ H	--
PCR3000WEA2	13 μ H to 667 μ H	40 μ H to 2000 μ H	53 μ H to 2667 μ H	160 μ H to 8000 μ H
PCR6000WEA2	7 μ H to 333 μ H	20 μ H to 1000 μ H	27 μ H to 1333 μ H	80 μ H to 4000 μ H
PCR12000WEA2	3 μ H to 167 μ arigaH	10 μ H to 500 μ H	13 μ H to 667 μ H	40 μ H to 2000 μ H
PCR18000WEA2	2 μ H to 111 μ H	7 μ H to 333 μ H	9 μ H to 444 μ H	27 μ H to 1333 μ H
PCR24000WEA2	2 μ H to 83 μ H	5 μ H to 250 μ H	7 μ H to 333 μ H	20 μ H to 1000 μ H
PCR30000WEA2	1 μ H to 67 μ H	4 μ H to 200 μ H	5 μ H to 267 μ H	16 μ H to 800 μ H
PCR36000WEA2	1 μ H to 56 μ H	3 μ H to 167 μ H	4 μ H to 222 μ H	13 μ H to 667 μ H

Response: MED

	L range		H range	
	Single-phase	Single-phase three-wire, Three phase	Single-phase	Single-phase three-wire, Three phase
PCR1000WEA	80 μ H to 2000 μ H	--	320 μ H to 8000 μ H	--
PCR2000WEA	40 μ H to 1000 μ H	--	160 μ H to 4000 μ H	--
PCR3000WEA2	27 μ H to 667 μ H	80 μ H to 2000 μ H	107 μ H to 2667 μ H	320 μ H to 8000 μ H
PCR6000WEA2	13 μ H to 333 μ H	40 μ H to 1000 μ H	53 μ H to 1333 μ H	160 μ H to 4000 μ H
PCR12000WEA2	7 μ H to 167 μ H	20 μ H to 500 μ H	27 μ H to 667 μ H	80 μ H to 2000 μ H
PCR18000WEA2	4 μ H to 111 μ H	13 μ H to 333 μ H	18 μ H to 444 μ H	53 μ H to 1333 μ H
PCR24000WEA2	3 μ H to 83 μ H	10 μ H to 250 μ H	13 μ H to 333 μ H	40 μ H to 1000 μ H
PCR30000WEA2	3 μ H to 67 μ H	8 μ H to 200 μ H	11 μ H to 267 μ H	32 μ H to 800 μ H
PCR36000WEA2	2 μ H to 56 μ H	7 μ H to 167 μ H	9 μ H to 222 μ H	27 μ H to 667 μ H

Response: SLOW

	L range		H range	
	Single-phase	Single-phase three-wire, Three phase	Single-phase	Single-phase three-wire, Three phase
PCR1000WEA	240 μ H to 2000 μ H	--	960 μ H to 8000 μ H	--
PCR2000WEA	120 μ H to 1000 μ H	--	480 μ H to 4000 μ H	--
PCR3000WEA2	80 μ H to 667 μ H	240 μ H to 2000 μ H	320 μ H to 2667 μ H	960 μ H to 8000 μ H
PCR6000WEA2	40 μ H to 333 μ H	120 μ H to 1000 μ H	160 μ H to 1333 μ H	480 μ H to 4000 μ H
PCR12000WEA2	20 μ H to 167 μ H	60 μ H to 500 μ H	80 μ H to 667 μ H	240 μ H to 2000 μ H
PCR18000WEA2	13 μ H to 111 μ H	40 μ H to 333 μ H	53 μ H to 444 μ H	160 μ H to 1333 μ H
PCR24000WEA2	10 μ H to 83 μ H	30 μ H to 250 μ H	40 μ H to 333 μ H	120 μ H to 1000 μ H
PCR30000WEA2	8 μ H to 67 μ H	24 μ H to 200 μ H	32 μ H to 267 μ H	96 μ H to 800 μ H
PCR36000WEA2	7 μ H to 56 μ H	20 μ H to 167 μ H	27 μ H to 222 μ H	80 μ H to 667 μ H

Unit: H

Settings are reset to default values when an *RST command is sent.

Example

```
OUTP:IMP:REAC 5UH
```

Response: NR3

OUTP:IMP:REAL

Sets the resistance component of the output impedances.

This command is valid when the output impedance is on (OUTP:IMP ON).

Command

```
OUTPut:IMPedance:REAL <numeric>[, (@chanlist)]
```

```
OUTPut:IMPedance:REAL? [ (@chanlist)]
```

Parameter

Value: Resistance component (The default value is 0.)

	L range		H range	
	Single-phase	Single-phase three-wire, Three phase	Single-phase	Single-phase three-wire, Three phase
PCR1000WEA	0 Ω to 2000 m Ω	--	0 Ω to 8000 m Ω	--
PCR2000WEA	0 Ω to 1000 m Ω	--	0 Ω to 4000 m Ω	--
PCR3000WEA2	0 Ω to 667 m Ω	0 Ω to 2000 m Ω	0 Ω to 2 667 m Ω	0 Ω to 8000 m Ω
PCR6000WEA2	0 Ω to 333 m Ω	0 Ω to 1000 m Ω	0 Ω to 1333 m Ω	0 Ω to 4000 m Ω
PCR12000WEA2	0 Ω to 167 m Ω	0 Ω to 500 m Ω	0 Ω to 667 m Ω	0 Ω to 2000 m Ω
PCR18000WEA2	0 Ω to 111 m Ω	0 Ω to 333 m Ω	0 Ω to 444 m Ω	0 Ω to 1333 m Ω
PCR24000WEA2	0 Ω to 83 m Ω	0 Ω to 250 m Ω	0 Ω to 333 m Ω	0 Ω to 1000 m Ω
PCR30000WEA2	0 Ω to 67 m Ω	0 Ω to 200 m Ω	0 Ω to 267 m Ω	0 Ω to 800 m Ω
PCR36000WEA2	0 Ω to 56 m Ω	0 Ω to 167 m Ω	0 Ω to 222 m Ω	0 Ω to 667 m Ω

Unit: OHM

Settings are reset to default values when an *RST command is sent.

Example

```
OUTP:IMP:REAL 50MOHM, (@1)
```

Response: NR3

OUTP:PHAS:OFF

Enables or disables output-off phase control.

If the signal source is set to external signal source VOLT:EXT:INP:EXTDC:SIGN:-SOUR EXT), this command is invalid.

Use OUTP:PHAS:OFF:LEV to set the output off phase angle.

Command

```
OUTPut:PHASe:OFF[:STATe] <boolean>
```

```
OUTPut:PHASe:OFF[:STATe]?
```

Parameter

Value: ON(1) Enables output-off phase control
OFF(0) Disables output-off phase control (default)

Settings are reset to default values when an *RST command is sent.

Example

```
OUTP:PHAS:OFF ON
```

Response: NR1

OUTP:PHAS:OFF:LEV

Sets the output off phase angle.

This command is valid for AC output when the output-off phase control is on (OUTP:PHAS:OFF ON).

If the signal source is set to external signal source VOLT:EXT:INP:EXTDC:SIGN:-SOUR EXT), this command is invalid.

Command

```
OUTPut:PHASe:OFF:LEVel <numeric>
```

```
OUTPut:PHASe:OFF:LEVel?
```

Parameter

Value: 0.0 to 360.0 (The default value is 0)

Unit: DEG

Settings are reset to default values when an *RST command is sent.

Example

```
OUTP:PHAS:OFF:LEV 90
```

Response: NR3

OUTP:PHAS:ON

Enables or disables output-on phase control.

If the signal source is set to external signal source VOLT:EXT:INP:EXTDC:SIGN:-SOUR EXT), this command is invalid.

Use OUTP:PHAS:ON:LEV to set the output-on phase angle.

Command

```
OUTPut:PHASe:ON[:STATe] <boolean>
```

```
OUTPut:PHASe:ON[:STATe]?
```

Parameter

Value: ON(1) Enables output-on phase control
OFF(0) Disables output-on phase control (default)

Settings are reset to default values when an *RST command is sent.

Example

```
OUTP:PHAS:ON ON
```

Response: NR1

OUTP:PHAS:ON:LEV

Sets the output-on phase angle.

This command is valid for AC output when the output-on phase control is on (OUTP:PHAS:ON ON).

If the signal source is set to external signal source VOLT:EXT:INP:EXTDC:SIGN:-SOUR EXT), this command is invalid.

Command

```
OUTPut:PHASe:ON:LEVel <numeric>
```

```
OUTPut:PHASe:ON:LEVel?
```

Parameter

Value: 0.0 to 360.0 (The default value is 0)

Unit: DEG

Settings are reset to default values when an *RST command is sent.

Example

```
OUTP:PHAS:ON:LEV 90
```

Response: NR3

OUTP:PON

Sets the output state that the PCR-WEA will be in when the power is turned on.

This command is valid when the power-on state setting is set to AUTO (SYST:CONF:OUTP:PON:STAT AUTO).

Command

```
OUTPut:PON[:STATe] <character>
```

```
OUTPut:PON[:STATe]?
```

Parameter

Value: SAFE Starts with the output turned off (default)
 FORC Starts with the output turned on.

Settings are reset to default values when an *RST command is sent.

Example

```
OUTP:PON FORC
```

Response: Characters

OUTP:PROT:CLE

Clears alarms.

Command

```
OUTPut:PROTection:CLEar
```

OUTP:PROT:WDOG

Enables or disables the communication monitoring (WATCHDOG) timer.

Use OUTP:PROT:WDOG:DEL to set the delay time of the communication monitoring (WATCHDOG) timer.

Command

```
OUTPut:PROTection:WDOG[:STATe] <boolean>
```

```
OUTPut:PROTection:WDOG[:STATe]?
```

Parameter

Value: ON(1) Enables the communication monitoring timer
 OFF(0) Disables the communication monitoring timer (default)

Example

```
OUTP:PROT:WDOG ON
```

Response: NR1

OUTP:PROT:WDOG:DEL

Sets the delay time of the communication monitoring (WATCHDOG) timer.

When an alarm occurs, disable the communication monitoring timer (OUTP:PROT:WDOG OFF) first and then clear the alarms (OUTP:PROT:CLE).

This command is valid when the communication monitoring timer is enabled (OUTP:PROT:WDOG ON).

Command

```
OUTPut:PROTection:WDOG:DELaY <numeric>
```

```
OUTPut:PROTection:WDOG:DELaY?
```

Parameter

Value: 1 to 3600 (The default value is 60)

Unit: S

Example

```
OUTP:PROT:WDOG:DEL 60
```

Response: NR3

OUTP:SST

Enables or disables soft start.

Use OUTP:SST:TIME to set the rise time.

You cannot enable soft start if the compensation is set to soft sensing function or regulation adjustment function (VOLT:COMP:MODE SOFT|RADJ).

Command

```
OUTPut:SSTart[:STATe][:RISE] <boolean>
```

```
OUTPut:SSTart[:STATe][:RISE]?
```

Parameter

Value: ON(1) Enables soft start
OFF(0) Disables soft start (default)

Settings are reset to default values when an *RST command is sent.

Example

```
OUTP:SST ON
```

Response: NR1

OUTP:SST:FALL

Enables or disables soft stop.

Use OUTP:SST:TIME:FALL to set the fall time.

You cannot enable soft stop if the compensation is set to soft sensing function or regulation adjustment function (VOLT:COMP:MODE SOFT|RADJ).

Command

```
OUTPut:SStart[:StAtE]:FALL <boolean>
```

```
OUTPut:SStart[:StAtE]:FALL?
```

Parameter

Value: ON(1) Enables soft stop
 OFF(0) Disables soft stop (default)

Settings are reset to default values when an *RST command is sent.

Example

```
OUTP:SST:FALL ON
```

Response: NR1

OUTP:SST:TIME

Sets the soft start rise time.

This command is valid when soft start is on (OUTP:SST ON).

Command

```
OUTPut:SStart:TIME[:RISE] <numeric>
```

```
OUTPut:SStart:TIME[:RISE]?
```

Parameter

Value: 0.1 to 30.0 (The default value is 0.1)

Unit: S

Settings are reset to default values when an *RST command is sent.

Example

```
OUTP:SST:TIME 1.2
```

Response: NR3

OUTP:SST:TIME:FALL

Sets the soft stop fall time.

This command is valid when soft stops are on (OUTP:SST:FALL ON).

Command

```
OUTPut:SStart:TIME:FALL <numeric>
```

```
OUTPut:SStart:TIME:FALL?
```

Parameter

Value: 0.1 to 3.0 (The default value is 0.1)

Unit: S

Settings are reset to default values when an *RST command is sent.

Example

```
OUTP:SST:TIME:FALL 1.2
```

Response: NR3

PROGrama Command

The sequence function is mapped to the PROGrama trigger subsystem.

->Tutorial "Sequence Operation (PROGrama)"(p. 345)

PROG:CLEAR

Sets all the steps in the sequence to their default values.

It takes about 3 seconds for the steps to return to their default values.

Command

PROGrama:CLEAr

PROG:EDIT

Collectively sets a sequence step (frequency, voltage, signal change, step time, waveform bank, status output, trigger I/O, output).

Command

```
PROG:EDIT <step_NRf>,<freq-ramp_boolean>,<freq_numeric>,<acv-ramp_boolean>,<acv_numeric>,<dcv-ramp_boolean>,<dcv_numeric>,<time_numeric>,<bank_NRf>,<status-out_boolean>,<trig-out_boolean>,<trig-in_boolean>,<output_boolean>
```

```
PROG:EDIT? <step_NRf>
```

Parameter <step_NRf>

Value: 0 to 599 Number of the step that you want to configure

Parameter <freq-ramp_boolean>

Value: ON(1) Enables the ramped frequency signal change
OFF(0) Disables the ramped frequency signal change (default)

Parameter <freq_numeric>

Value: 1 to 5000 Frequency (The default value is 50)

Unit: HZ

Parameter <acv-ramp_boolean>

Value: ON(1) Enables the ramped AC voltage signal change
OFF(0) Disables the ramped AC voltage signal change (default)

Parameter <acv_numeric>

Value: 0 to 322.0 AC voltage (The default value is 0)

Unit: V

Parameter <dcv-ramp_boolean>

Value: ON(1) Enables the ramped DC voltage signal change
OFF(0) Disables the ramped DC voltage signal change (default)

Parameter <dcv_numeric>

Value: 0 to ± 455.0 DC voltage (The default value is 0)

Unit: V

Parameter <time_numeric>

Value: 0.0001 s to 1000h Step time (The default value is 0.01 s)

Unit: S

Parameter <bank_NrF>

Value: 0 to 256 Number of the waveform bank to use (The default value is 0)

Parameter <status-out_boolean>

Value: ON(1) Enables status output
OFF(0) Disables status output (default)

Parameter <trig-out_boolean>

Value: ON(1) Enables trigger output
OFF(0) Disables trigger output (default)

Parameter <trig-in_boolean>

Value: ON(1) Enables trigger input
OFF(0) Disables trigger input (default)

Parameter <output_boolean>

Value: ON(1) Output on (default)
OFF(0) Output off

Example

```
PROG:EDIT 1,OFF,60HZ,OFF,100V,OFF,0V,10S,0,OFF,OFF,OFF,ON
```

Response

Returns the settings of the specified step in the following order in response to PROG:EDIT? <step_NrF>.

Frequency signal change <NR1>,frequency <NR3>,AC voltage signal change <NR1>,AC voltage^{*2} <NR3>, DC voltage signal change <NR1>, DC voltage^{*3} <NR3>, step execution time <NR3>, waveform bank number <NR1>, status output <NR1>, trigger output <NR1>, trigger input <NR1>, output on/off <NR1>

*2. For single-phase three-wire output and three-phase output, the U phase AC voltage is returned when the unbalanced voltage is set.

*3. For single-phase three-wire output and three-phase output, the U phase DC voltage is returned when the unbalanced voltage is set.

PROG:EDIT:FUNC:BANK

Sets the waveform bank number of the sequence step.

Command

```
PROG:EDIT:FUNCtion[:SHAPE]:BANK[:INDEX] <step_Nrf>,<bank_Nrf>[,@
chanlist]
```

```
PROG:EDIT:FUNCtion[:SHAPE]:BANK[:INDEX]? <step_Nrf>[,@chanlist]
```

Parameter <step_Nrf>

Value: 0 to 599 Number of the step that you want to configure

Parameter <bank_Nrf>

Value: 0 to 256 Number of the waveform bank to use (The default value is 0)

Example

```
PROG:EDIT:FUNC:BANK 1,256
```

Response

Returns the waveform bank number of the designated step in NR1 format in response to PROG:EDIT:FUNC:BANK? <step_Nrf>.

PROG:EDIT:JUMP

Configures the jump settings of a sequence step.

Command

```
PROG:EDIT:JUMP <step_NRf>,<jump-enable_boolean>,<jump-step_
  NRf>,<jump-count_NRf>
```

```
PROG:EDIT:JUMP? <step_NRf>
```

Parameter <step_NRf>

Value: 0 to 599 Number of the step that you want to configure

Parameter <jump-enable_boolean>

Value: ON(1) Execution will jump to the specified step.

OFF(0) Execution will proceed to the subsequent step. (default)

Parameter <jump-step_NRf>

Value: 0 to 599 Jump destination step number (The default value is 0)

Parameter <jump-count_NRf>

Value: 1 to 99998 Jump repetition count (The default value is 1.)

99999 Repeated indefinitely

Example

```
PROG:EDIT:JUMP 5,ON,1,10
```

Response

Returns the jump settings of the specified step in the following order.

Whether a jump will be performed <NR1>,jump destination step number

<NR1>,number of jump repetitions <NR1>

PROG:EDIT:IMP

Sets whether to set the output impedance in the sequence step.

Use PROG:EDIT:IMP:REAC/PROG:EDIT:IMP:REAL to set the output impedance.

Command

```
PROG:EDIT:IMPedance[:STATe] <step_NRf>,<imp_boolean>
```

```
PROG:EDIT:IMPedance[:STATe]? <step_NRf>
```

Parameter <step_NRf>

Value: 0 to 599 Number of the step that you want to configure

Parameter <imp_boolean>

Value: ON(1) The output impedance will be set.

OFF(0) The output impedance will not be set (default).

Example

```
PROG:EDIT:IMP 1,ON
```

Response: NR1

PROG:EDIT:IMP:REAC

Sets the reactance component of the output impedance used in the sequence step.

This command is valid when the output impedance (PROG:EDIT:IMP) of the sequence is to be set.

Command

```
PROG:EDIT:IMP:REACTIVE <step_NrF>,<reac_NrF>[,@chanlist]
```

```
PROG:EDIT:IMP:REACTIVE? <step_NrF>[,(@chanlist)]
```

Parameter <step_NrF>

Value: 0 to 599 Number of the step that you want to configure

Parameter <reac_NrF>

Value: Reactance component (The default value is 0.)

Response: FAST

	L range		H range	
	Single-phase	Single-phase three-wire, Three phase	Single-phase	Single-phase three-wire, Three phase
PCR1000WEA	40 μ H to 2000 μ H	--	160 μ H to 8000 μ H	--
PCR2000WEA	20 μ H to 1000 μ H	--	80 μ H to 4000 μ H	--
PCR3000WEA2	13 μ H to 667 μ H	40 μ H to 2000 μ H	53 μ H to 2667 μ H	160 μ H to 8000 μ H
PCR6000WEA2	7 μ H to 333 μ H	20 μ H to 1000 μ H	27 μ H to 1333 μ H	80 μ H to 4000 μ H
PCR12000WEA2	3 μ H to 167 μ H	10 μ H to 500 μ H	13 μ H to 667 μ H	40 μ H to 2000 μ H
PCR18000WEA2	2 μ H to 111 μ H	7 μ H to 333 μ H	9 μ H to 444 μ H	27 μ H to 1333 μ H
PCR24000WEA2	2 μ H to 83 μ H	5 μ H to 250 μ H	7 μ H to 333 μ H	20 μ H to 1000 μ H
PCR30000WEA2	1 μ H to 67 μ H	4 μ H to 200 μ H	5 μ H to 267 μ H	16 μ H to 800 μ H
PCR36000WEA2	1 μ H to 56 μ H	3 μ H to 167 μ H	4 μ H to 222 μ H	13 μ H to 667 μ H

Response: MED

	L range		H range	
	Single-phase	Single-phase three-wire, Three phase	Single-phase	Single-phase three-wire, Three phase
PCR1000WEA	80 μ H to 2000 μ H	--	320 μ H to 8000 μ H	--
PCR2000WEA	40 μ H to 1000 μ H	--	160 μ H to 4000 μ H	--
PCR3000WEA2	27 μ H to 667 μ H	80 μ H to 2000 μ H	107 μ H to 2667 μ H	320 μ H to 8000 μ H
PCR6000WEA2	13 μ H to 333 μ H	40 μ H to 1000 μ H	53 μ H to 1333 μ H	160 μ H to 4000 μ H
PCR12000WEA2	7 μ H to 167 μ H	20 μ H to 500 μ H	27 μ H to 667 μ H	80 μ H to 2000 μ H
PCR18000WEA2	4 μ H to 111 μ H	13 μ H to 333 μ H	18 μ H to 444 μ H	53 μ H to 1333 μ H
PCR24000WEA2	3 μ H to 83 μ H	10 μ H to 250 μ H	13 μ H to 333 μ H	40 μ H to 1000 μ H
PCR30000WEA2	3 μ H to 67 μ H	8 μ H to 200 μ H	11 μ H to 267 μ H	32 μ H to 800 μ H
PCR36000WEA2	2 μ H to 56 μ H	7 μ H to 167 μ H	9 μ H to 222 μ H	27 μ H to 667 μ H

Response: SLOW

	L range		H range	
	Single-phase	Single-phase three-wire, Three phase	Single-phase	Single-phase three-wire, Three phase
PCR1000WEA	240 μ H to 2000 μ H	--	960 μ H to 8000 μ H	--
PCR2000WEA	120 μ H to 1000 μ H	--	480 μ H to 4000 μ H	--
PCR3000WEA2	80 μ H to 667 μ H	240 μ H to 2000 μ H	320 μ H to 2667 μ H	960 μ H to 8000 μ H
PCR6000WEA2	40 μ H to 333 μ H	120 μ H to 1000 μ H	160 μ H to 1333 μ H	480 μ H to 4000 μ H
PCR12000WEA2	20 μ H to 167 μ H	60 μ H to 500 μ H	80 μ H to 667 μ H	240 μ H to 2000 μ H
PCR18000WEA2	13 μ H to 111 μ H	40 μ H to 333 μ H	53 μ H to 444 μ H	160 μ H to 1333 μ H
PCR24000WEA2	10 μ H to 83 μ H	30 μ H to 250 μ H	40 μ H to 333 μ H	120 μ H to 1000 μ H
PCR30000WEA2	8 μ H to 67 μ H	24 μ H to 200 μ H	32 μ H to 267 μ H	96 μ H to 800 μ H
PCR36000WEA2	7 μ H to 56 μ H	20 μ H to 167 μ H	27 μ H to 222 μ H	80 μ H to 667 μ H

Unit: H

Example

```
PROG:EDIT:IMP:REAC 1,1UH
```

Response: NR3

PROG:EDIT:IMP:REAL

Sets the resistance component of the output impedance used in the sequence step.

This command is valid when the output impedance (PROG:EDIT:IMP) of the sequence is to be set.

Command

```
PROG:EDIT:IMP:REAL <step_NRf>,<real_NRf>[,@chanlist]
```

```
PROG:EDIT:IMP:REAL? <step_NRf>[,@chanlist]
```

Parameter <step_NRf>

Value: 0 to 599 Number of the step that you want to configure

Parameter <real_NRf>

Value: Resistance component (The default value is 0.)

	L range		H range	
	Single-phase	Single-phase three-wire, Three phase	Single-phase	Single-phase three-wire, Three phase
PCR1000WEA	0 Ω to 2000 m Ω	--	0 Ω to 8000 m Ω	--
PCR2000WEA	0 Ω to 1000 m Ω	--	0 Ω to 4000 m Ω	--
PCR3000WEA2	0 Ω to 667 m Ω	0 Ω to 2000 m Ω	0 Ω to 2 667 m Ω	0 Ω to 8000 m Ω
PCR6000WEA2	0 Ω to 333 m Ω	0 Ω to 1000 m Ω	0 Ω to 1333 m Ω	0 Ω to 4000 m Ω
PCR12000WEA2	0 Ω to 167 m Ω	0 Ω to 500 m Ω	0 Ω to 667 m Ω	0 Ω to 2000 m Ω
PCR18000WEA2	0 Ω to 111 m Ω	0 Ω to 333 m Ω	0 Ω to 444 m Ω	0 Ω to 1333 m Ω
PCR24000WEA2	0 Ω to 83 m Ω	0 Ω to 250 m Ω	0 Ω to 333 m Ω	0 Ω to 1000 m Ω
PCR30000WEA2	0 Ω to 67 m Ω	0 Ω to 200 m Ω	0 Ω to 267 m Ω	0 Ω to 800 m Ω
PCR36000WEA2	0 Ω to 56 m Ω	0 Ω to 167 m Ω	0 Ω to 222 m Ω	0 Ω to 667 m Ω

Unit: OHM

Example

```
PROG:EDIT:IMP:REAL 1,50MOHM
```

Response: NR3

PROG:EDIT:PHAS:RAMP

Sets the phase signal change of a sequence step.

Set the U phase angle with the U phase offset (PROG:EDIT:PHAS:UOFF).

Set the V phase angle with the U-V phase difference (PROG:EDIT:PHAS:UV).

Set the W phase angle with the U-W phase difference (PROG:EDIT:PHAS:UW).

This command is valid for three-phase output or two-phase output.

Command

```
PROG:EDIT:PHAS:RAMP <step_NRf>,<u-phase_character>[,<v-phase_
  character>[,<w-phase_character>]]
```

```
PROG:EDIT:PHAS:RAMP? <step_NRf>
```

Parameter <step_NRf>

Value: 0 to 599 Number of the step that you want to configure

Parameter <u-phase_character> U phase signal change, <v-phase_character> V phase signal change, <w-phase_character> W phase signal change

Value:	OFF	Ramp off (default)
	LEAD	Ramp on, leading
	LAG	Ramp on, lagging

Example

```
PROG:EDIT:PHAS:RAMP 1,LAG,OFF,OFF
```

```
PROG:EDIT:PHAS:RAMP? 1
```

Response

Returns the phase signal change settings of the specified step in the following order.

U phase signal change<characters>, V phase signal change<characters>, W phase signal change<characters>

PROG:EDIT:PHAS:STAR

Sets the starting phase angle and whether to suddenly change the phase of the sequence step.

Command

```
PROG:EDIT:PHAS:STAR <step_NRf>,<enable_boolean>[,<phase_
NR3>[,<phase_change_boolean>]]
```

```
PROG:EDIT:PHAS:STAR? <step_NRf>
```

Parameter <step_NRf>

Value: 0 to 599 Number of the step that you want to configure

Parameter <enable_boolean>

Value: ON(1) Enables phase control
OFF(0) Disables phase control (default)

Parameter <phase_NR3>

Value: 0.0 to 360.0 Starting phase angle (The default value is 0)
0 and 360 are the same.

Unit: DEG

Parameter <phase_change_boolean>

Value: ON(1) Enables sudden phase change
OFF(0) Disables sudden phase change (default)

Example

```
PROG:EDIT:PHAS:STAR 1,ON,90,OFF
```

```
PROG:EDIT:PHAS:STAR? 1
```

Response

Returns the starting phase angle and the sudden phase change setting of the specified step in the following order.

Phase control enabled/disabled<NR1>, starting phase angle<NR3>, sudden phase change setting<NR1>

PROG:EDIT:PHAS:STOP

Sets the ending phase angle of the sequence step.

Command

```
PROG:EDIT:PHAS:STOP <step_Nrf>,<enable_boolean>,[<phase_NR3>]
```

```
PROG:EDIT:PHAS:STOP? <step_Nrf>
```

Parameter <step_Nrf>

Value: 0 to 599 Number of the step that you want to configure

Parameter <enable_boolean>

Value: ON(1) Enables phase control
OFF(0) Disables phase control (default)

Parameter <phase_NR3>

Value: 0.0 to 360.0 Ending phase angle (The default value is 0)
0 and 360 are the same.

Unit: DEG

Example

```
PROG:EDIT:PHAS:STOP 1,ON,90
```

```
PROG:EDIT:PHAS:STOP? 1
```

Response

Returns the ending phase angle of the specified step in the following order.

Phase control enabled/disabled<NR1>, ending phase angle<NR3>

PROG:EDIT:PHAS:UOFF

Sets the U phase offset phase angle of a sequence step.

Use PROG:EDIT:PHAS:RAMP to set the phase signal change.

This command is valid for three-phase output.

Command

```
PROG:EDIT:PHAS:UOFFset <step_NRf>,<enable_boolean>,<phase_NR3>
```

```
PROG:EDIT:PHAS:UOFFset? <step_NRf>
```

Parameter <step_NRf>

Value: 1 to 599 Number of the step that you want to configure

Parameter <enable_boolean>

Value: ON(1) Enables U phase offset

OFF(0) Disables the U phase offset (default)

Parameter <phase_NR3>

Value: -360.00 to 360.00 U phase offset value (The default value is 0)

Unit: DEG

Example

```
PROG:EDIT:PHAS:UOFF 1,ON,90
```

Response

Returns the U phase offset value of the specified step in the following order.

U phase offset enabled/disabled<NR1>, U phase offset value<NR3>

PROG:EDIT:PHAS:UV

Sets the U-V phase difference of the sequence step.

Use PROG:EDIT:PHAS:RAMP to set the phase signal change.

This command is valid for three-phase output or two-phase output.

Command

```
PROG:EDIT:PHAS:UV <step_Nr>,<enable_boolean>,<phase_NR3>
```

```
PROG:EDIT:PHAS:UV? <step_Nr>
```

Parameter <step_Nr>

Value: 0 to 599 Number of the step that you want to configure

Parameter <enable_boolean>

Value: ON(1) Enables U-V phase difference control

OFF(0) Disables U-V phase difference control (default)

Parameter <phase_NR3>

Value: 0.00 to 360.00 U-V phase difference (The default value is 0)
0 and 360 are the same.

Unit: DEG

Example

```
PROG:EDIT:PHAS:UV 1,ON,90
```

```
PROG:EDIT:PHAS:UV? 1
```

Response

Returns the U-V phase difference of the specified step in the following order.

U-V phase difference control enabled/disabled<NR1>, U-V phase difference<NR3>

PROG:EDIT:PHAS:UW

Sets the U-W phase difference of the sequence step.

Use PROG:EDIT:PHAS:RAMP to set the phase signal change.

This command is valid for three-phase output.

Command

```
PROG:EDIT:PHAS:UW <step_NRf>,<enable_boolean>,<phase_NR3>
```

```
PROG:EDIT:PHAS:UW? <step_NRf>
```

Parameter <step_NRf>

Value: 0 to 599 Number of the step that you want to configure

Parameter <enable_boolean>

Value: ON(1) Enables U-W phase difference control
OFF(0) Disables U-W phase difference control (default)

Parameter <phase_NR3>

Value: 0.00 to 360.00 U-W phase difference (The default value is 0)

Unit: DEG

Example

```
PROG:EDIT:PHAS:UW 1,ON,90
```

```
PROG:EDIT:PHAS:UW? 1
```

Response

Returns the U-W phase difference of the specified step in the following order.

U-W phase difference control enabled/disabled<NR1>, U-W phase difference<NR3>

PROG:EDIT:VOLT

Sets the unbalanced AC voltage of the sequence step

Command

```
PROGrama:EDIT:VOLTage <step_NRf>,<volt_NRf>[,@chanlist]
```

```
PROGrama:EDIT:VOLTage? <step_NRf>
```

Parameter <step_NRf>

Value: 0 to 599 Number of the step that you want to configure

Parameter

Value: 0.0 to 322.0 Unbalanced AC voltage (The default value is 0)

Unit: V

Example

```
PROG:EDIT:VOLT 2,50,(@2)
```

```
PROG:EDIT:VOLT? 2
```

Response: NR3

PROG:EDIT:VOLT:OFFS

Sets the unbalanced DC voltage of the sequence step

Command

```
PROG:EDIT:VOLTage:OFFSet <step_NrF>,<volt_NrF>[,@chanlist]
```

```
PROG:EDIT:VOLTage:OFFSet? <step_NrF>
```

Parameter <step_NrF>

Value: 0 to 599 Number of the step that you want to configure

Parameter

Value: -455.0 to 455.0 Unbalanced DC voltage (The default value is 0)

Unit: V

Example

```
PROG:EDIT:VOLT:OFFS 1,-50
```

```
PROG:EDIT:VOLT:OFFS? 1
```

Response: NR3

PROG:EXEC

Queries the sequence execution state.

Command

```
PROGrama:EXECuting?
```

Response

Returns the execution state (STOP, RUN, or PAUSE) <characters>, elapsed step time (the unit is seconds) <NR3>, present repetition number <NR1>, and step number ("-1" if the sequence is not being executed) <NR1> as a comma-separated list.

PROG:LOOP

Sets the sequence repetition count.

This command is invalid while a sequence is running.

Command

```
PROG:LOOP <NR1>
```

```
PROG:LOOP?
```

Parameter

Value:	1 to 99998	Repeat count (The default value is 1.)
	99999	Repeated indefinitely

Example

```
PROG:LOOP 100
```

Response: NR1

PROG:STAT

Changes the execution state of the sequence.

If the signal source is set to external signal source VOLT:EXT:INP:EXTDC:SIGN:-SOUR EXT), this command is invalid.

Command

```
PROG:STATe <character>
```

Parameter

Value:	STOP	Stops the sequence
	RUN	Executing Sequences
	PAUSE	Pausing a sequence
	CONTINUE	Continues the sequence that has been paused

Example

```
PROG:STAT PAUS
```

PROG:STEP:END

Sets the sequence ending step number

Command

```
PROG:STEP:END <NR1>
```

```
PROG:STEP:END?
```

Parameter

Value: 0 to 599

Example

```
PROG:STEP:END 20
```

Response: NR1

PROG:STEP:STAR

Sets the sequence starting step number

Command

```
PROG:STEP:START <NR1>
```

```
PROG:STEP:START?
```

Parameter

Value: 0 to 599

Example

```
PROG:STEP:STAR 10
```

Response: NR1

SENSe Command

SENS:AVER:COUN

Sets the moving average count for current measurement.

Averaging is not performed when this is set to 1.

Command

```
SENSe:AVERage:COUNT <NR1>
```

```
SENSe:AVERage:COUNT?
```

Parameter

Value: 1 to 32 (The default value is 1)

Settings are reset to default values when an *RST command is sent.

Example

```
SENS:AVER:COUN 16
```

Response: NR1

SENS:CURR:HOLD:CLE

Clears the hold of the peak current value.

Command

```
SENSe:CURRent [ :PEAK ] :HOLD:CLEar
```

SENS:VOLT:AVER:COUN

Sets the moving average count for voltage measurement.

Averaging is not performed when this is set to 1.

Command

```
SENSe:VOLTage:AVERage:COUNT <NRf>
```

```
SENSe:VOLTage:AVERage:COUNT?
```

Parameter

Value: 1 to 32 (The default value is 1)

Settings are reset to default values when an *RST command is sent.

Example

```
SENS:VOLTage:AVER:COUN 16
```

Response: NR1

SENS:VOLT:HOLD:CLE

Clears the hold of the peak voltage value.

Command

```
SENSe:VOLTage [:PEAK]:HOLD:CLEar
```

SIMulation Command

Power line abnormality simulation is mapped to the SIMulation trigger subsystem.

Power line abnormality simulation is valid for AC output.

->Tutorial "Power line abnormality simulations (SIMulation)"(p. 342)

SIM:EXEC

Queries the execution status of power line abnormality simulations.

Command

```
SIMulation:EXECuting?
```

Response

Returns the execution state (STOP or RUN) <characters> and the number of repetitions <NR1> as a comma-separated list.

SIM:POL

Sets the voltage regulation polarity of power line abnormality simulations.

Command

```
SIMulation:POLarity <character>
```

```
SIMulation:POLarity?
```

Parameter

Value: **NORMal** Positive polarity is used (default).
 INVerted Negative polarity is used.

Example

```
SIM:POL INV
```

Response: Characters

SIM:REP:COUN

Sets the number of repetitions of power line abnormality simulations.

Command

```
SIMulation:REPeat:COUNT <NRf>
```

```
SIMulation:REPeat:COUNT?
```

Parameter

Value: 1 to 9998 Repeat count (The default value is 9999.)
9999 Repeated indefinitely

Example

```
SIM:REP:COUN 100
```

Response: NR1

SIM:STAT

Executes or stops a power line abnormality simulation.

This command is valid for AC output.

This command is invalid when the output is off (OUTP OFF).

If the signal source is set to external signal source (FUNC:SOUR EXT), this command is invalid.

Command

```
SIMulation:STATe <character>
```

Parameter

Value:	STOP	Stops the power line abnormality simulation
	RUN	Executes the power line abnormality simulation

Example

```
SIM:STAT STOP
```

SIM:T1:PHAS

Sets the voltage regulation starting phase of power line abnormality simulations.

This command is valid when voltage regulations are configured to be set by phase (SIM:T1:PHAS:STAT ON).

Command

```
SIMulation:T1:PHASe[:LEVel] <numeric>
```

```
SIMulation:T1:PHASe[:LEVel]?
```

Parameter

Value: 0.0 to 359.9 Voltage regulation starting phase (The default value is 0)

Unit: DEG

Example

```
SIM:T1:PHAS 89.5
```

Response: NR3

SIM:T1:PHAS:STAT

Selects whether the voltage regulation start of power line abnormality simulations will be set in terms of time or in terms of phase.

When you have selected time, use SIM:T1:TIME to set the voltage regulation start time.

When you have selected phase, use SIM:T1:PHAS to set the voltage regulation starting phase.

Command

```
SIMulation:T1:PHASe:STATe <boolean>
```

```
SIMulation:T1:PHASe:STATe?
```

Parameter

Value: ON(1) The value is set in terms of phase.
OFF(0) The value is set in terms of time (default).

Example

```
SIM:T1:PHAS:STAT 0
```

Response: NR1

SIM:T1:TIME

Sets the voltage regulation starting time of power line abnormality simulations.

This command is valid when voltage regulations are configured to be set by time (SIM:T1:PHAS:STAT OFF).

Command

```
SIMulation:T1:TIME[:LEVel] <numeric>
```

```
SIMulation:T1:TIME[:LEVel]?
```

Parameter

Value: 0.0000 to 0.9999 Voltage regulation starting time (The default value is 0.1)

Unit: S

Example

```
SIM:T1:TIME 4.5MS
```

Response: NR3

SIM:T2:TIME

Sets slope time 1 of power line abnormality simulations.

Command

```
SIMulation:T2:TIME[:LEVel] <numeric>
```

```
SIMulation:T2:TIME[:LEVel]?
```

Parameter

Value: 0.000 to 99.990 Slope time 1 (The default value is 0)

Unit: S

Example

```
SIM:T2:TIME 45MS
```

Response: NR3

SIM:T3:TIME

Sets the voltage regulation time of power line abnormality simulations.

Command

```
SIMulation:T3:TIME[:LEVel] <numeric>
```

```
SIMulation:T3:TIME[:LEVel]?
```

Parameter

Value: 0.0000 to 9.9990 Voltage regulation time (The default value is 0.1)

Unit: S

Example

```
SIM:T3:TIME 4.5MS
```

Response: NR3

SIM:T3:VOLT

Sets the regulated voltage of power line abnormality simulations.

Command

```
SIMulation:T3:VOLTage[:LEVel] <numeric>
```

```
SIMulation:T3:VOLTage[:LEVel]?
```

Parameter

Value: 0.0 to 322.0 Regulated voltage (The default value is 0)

Unit: V

Example

```
SIM:T3:VOLT 120V
```

Response: NR3

SIM:T4:TIME

Sets slope time 2 of power line abnormality simulations.

Command

```
SIMulation:T4:TIME[:LEVel] <numeric>
```

```
SIMulation:T4:TIME[:LEVel]?
```

Parameter

Value: 0.000 to 99.990 Slope time 2 (The default value is 0)

Unit: S

Example

```
SIM:T4:TIME 45MS
```

Response: NR3

SIM:T5:CYCL

Sets the number of return cycles of power line abnormality simulations.

This command is valid when the period that the PCR-WEA remains in the returned state is configured to be set in terms of cycles (SIM:T5:CYCL:STAT ON).

Command

```
SIMulation:T5:CYCLe[:LEVel] <numeric>
```

```
SIMulation:T5:CYCLe[:LEVel]?
```

Parameter

Value: 0 to 999900 (The default value is 0)

Example

```
SIM:T5:CYCL 100
```

Response: NR1

SIM:T5:CYCL:STAT

Selects whether the period that the PCR-WEA remains in the returned state is configured in terms of time or in terms of cycles for power line abnormality simulations.

When you have selected time, use SIM:T5:TIME to set the return time.

When you have selected cycles, use SIM:T5:CYCL to set the number of return cycles.

Command

```
SIMulation:T5:CYCLe:STATe <boolean>
```

```
SIMulation:T5:CYCLe:STATe?
```

Parameter

Value: ON(1) The value is set in terms of cycles.
OFF(0) The value is set in terms of time (default).

Example

```
SIM:T5:CYCL:STAT 1
```

Response: NR1

SIM:T5:TIME

Sets the return time of power line abnormality simulations.

This command is valid when the period that the PCR-WEA remains in the returned state is configured to be set in terms of time (SIM:T5:CYCL:STAT OFF).

Command

```
SIMulation:T5:TIME[:LEVel] <numeric>
```

```
SIMulation:T5:TIME[:LEVel]?
```

Parameter

Value: 0.000 to 99.990 Return time (The default value is 0.1)

Unit: S

Example

```
SIM:T5:TIME 45MS
```

Response: NR3

[SOURCE:]CURRENT Command

CURR

Sets the upper limit of the output current.

Command

```
[SOURCE:]CURRENT[:LEVEL][:IMMEDIATE][:AMPLITUDE] <numeric>[, (@chan-  
list)]
```

```
[SOURCE:]CURRENT[:LEVEL][:IMMEDIATE][:AMPLITUDE]? [(@chanlist)]
```

Parameter

Value: 10 % of the maximum current [A] to 110 % of the maximum current [A]
(The default value is MAXimum)

Unit: A

Settings are reset to default values when an *RST command is sent.

Example

```
CURR 25
```

Response: NR3

CURR:PEAK

Sets the output current peak limit of the positive electric potential

Command

```
[SOURce:]CURRent:PEAK[:UPPer][:IMMediate] <numeric>[, (@chanlist)]
```

```
[SOURce:]CURRent:PEAK[:UPPer][:IMMediate]? [(@chanlist)]
```

Parameter

Value: 10 % of the maximum current [A] to 420 % of the maximum current [A]
(The default value is MAXimum)

Unit: A

Settings are reset to default values when an *RST command is sent.

Example

```
CURR:PEAK 120
```

Response: NR3

CURR:PEAK:LOW

Sets the output current peak limit of the negative electric potential

Command

```
[SOURce:]CURRent:PEAK:LOWer[:IMMediate] <numeric>[, (@chanlist)]
```

```
[SOURce:]CURRent:PEAK:LOWer[:IMMediate]? [ (@chanlist)]
```

Parameter

Value: 10 % of the maximum current [A] to 420 % of the maximum current [A]
(The default value is MAXimum)

Unit: A

Settings are reset to default values when an *RST command is sent.

Example

```
CURR:PEAK:LOW -120
```

Response: NR3

CURR:PROT:STAT

Sets how the PCR-WEA acts when the current limit is exceeded.

When you have specified the ON parameter (to select TRIP), use the CURR:PROT:TRIP:DEL command to set the time that must elapse after a limit has been exceeded before the protection functions are tripped.

Command

```
[SOURCE:]CURRENT:PROTECTION:STATE <boolean>
```

```
[SOURCE:]CURRENT:PROTECTION:STATE?
```

Parameter

Value:	ON(1)	TRIP (when an overload occurs for longer than the specified time, the output is turned off, and an alarm is generated) (default)
	OFF(0)	OFF(0) CC (decreases the output so that the current limit is not exceeded when an overloading occurs)

Settings are reset to default values when an *RST command is sent.

Example

```
CURR:PROT:STAT 1
```

Response: NR1

CURR:PROT:TRIP:DEL

Sets the time that must elapse before the output is turned off when the current limit is exceeded

The action that is performed when the limit is exceeded is valid when TRIP (CURR:PROT:STAT ON) has been selected.

Command

```
[SOURce:]CURRent:PROTection:TRIP:DELaY <numeric>
```

```
[SOURce:]CURRent:PROTection:TRIP:DELaY?
```

Parameter

Value: 0.0 to 10.0 Time until the output is turned off (The default value is 10)

Unit: S

Settings are reset to default values when an *RST command is sent.

Example

```
CURR:PROT:TRIP:DEL 3.5
```

Response: NR3

FREQ:LIM:LOW

Sets the lower frequency limit.

If the signal source is set to external signal source (VOLT:EXT:EXTDC:SIGN:SOUR EXT), this command is invalid.

The following relationship must be met: $FREQ:LIM:LOW \leq FREQ|FREQ:TRIG \leq FREQ:LIM:UPP$

Command

```
[SOURce:]FREQuency:LIMit:LOWer <numeric>
```

```
[SOURce:]FREQuency:LIMit:LOWer?
```

Parameter

Value: 1.00 to 5000 Frequency (The default value is 1.00)
1.00 to 500.0 on the 500 Hz limit model

Unit: HZ

Settings are reset to default values when an *RST command is sent.

Example

```
FREQ:LIM:LOW 40
```

Response: NR3

FREQ:SYNC

Sets the sync function.

If the signal source is set to external signal source (VOLT:EXT:EXTDC:SIGN:SOUR EXT), this command is invalid.

Use FREQ:SYNC:PHASE:DEL to set the synchronization delay phase angle.

Command

```
[SOURce:]FREQuency:SYNChronize[:STATe] <boolean>
```

```
[SOURce:]FREQuency:SYNChronous[:STATe]?
```

Parameter

Value: ON(1) Using the Synchronization Function
OFF(0) The synchronization function is disabled (default).

Settings are reset to default values when an *RST command is sent.

Example

```
FREQ:SYNC ON
```

Response: NR1

FREQ:SYNC:MODE

Sets the input sync signal of the sync function.

Command

```
[SOURce:]FREQuency:SYNChronous:MODE <character>
```

```
[SOURce:]FREQuency:SYNChronous:MODE?
```

Parameter

Value: **LINE** Synchronizes to the input power supply (default)
 EXternal Synchronizes to an external sync input signal

Settings are reset to default values when an *RST command is sent.

Example

```
FREQ:SYNC:MODE LINE
```

Response: Characters

FREQ:SYNC:PHAS:DEL

Sets the synchronization delay phase angle of the synchronization function.

This command is valid when the sync function is on (FREQ:SYNC ON).

Command

```
[SOURce:]FREQuency:SYNChronous:PHASe:DELay <numeric>
```

```
[SOURce:]FREQuency:SYNChronous:PHASe:DELay?
```

Parameter

Value: 0 to 360.0 Synchronization delay phase angle (The default value is 0)
0 and 360 are the same.

Unit: DEG

Settings are reset to default values when an *RST command is sent.

Example

```
FREQ:SYNC:PHAS:DEL 70.5
```

Response: NR3

[SOURce:]FUNcTION Command

FUNC:BANK

Specifies the number of the waveform bank that you want to execute.

This command is invalid when the sync function is enabled (FREQ:SYNC ON).

This command is invalid if the compensation function is set to the soft sensing function or the regulation adjustment function (VOLT:COMP:MODE SOFT|RADJ).

If the signal source is set to external signal source (VOLT:EXT:EXTDC:SIGN:SOUR EXT), this command is invalid.

Command

```
[SOURce:]FUNcTION[:SHAPE]:BANK[:INDEx] <NR1>[, (@chanlist)]
```

```
[SOURce:]FUNcTION[:SHAPE]:BANK[:INDEx]? [(@chanlist)]
```

Parameter

Value 0 to 256 (The default value is 0)

Settings are reset to default values when an *RST command is sent.

Example

```
FUNC:BANK 5
```

Response: NR1

[SOURce:]VOLTage Command

VOLT

Set the AC voltage.

This command is invalid when the combined value with the DC voltage is outside the allowable range (L range: -227.7 V to 227.7 V, H range: -455.0 V to 455.0 V).

If the signal source is set to external signal source (VOLT:EXT:EXTDC:SIGN:SOUR EXT), this command is invalid.

This command is invalid when an external analog signal is used to control the voltage or frequency (VOLT:EXT:FUNC:MODE VPR).

Command

```
[SOURce:]VOLTage[:LEVel][:IMMediate][:AMPLitude] <numeric>[, (@chan-  
list)]
```

```
[SOURce:]VOLTage[:LEVel][:IMMediate][:AMPLitude]? [(@chanlist)]
```

Parameter

Value: 0 to 161.0 AC voltage in the L range
0 to 322.0 AC voltage in the H range
(The default value is 0.)

Unit: V

Settings are reset to default values when an *RST command is sent.

Example

```
VOLT 120
```

Response: NR3

VOLT:COMP:MODE

Sets the compensation (voltage compensation).

Command

```
[SOURce:]VOLTage:COMPensate:MODE <character>
```

```
[SOURce:]VOLTage:COMPensate:MODE?
```

Parameter

Value:	DISabled	Disables the compensation (default)
	HARD	Enables hard sensing
	SOFT	Enables soft sensing
	RADJust	Enables regulation adjustment

Settings are reset to default values when an *RST command is sent.

Example

```
VOLT:COMP:MODE HARD
```

Response: Characters

VOLT:COMP:RADJ

Sets the voltage to correct with regulation adjustment.

This is valid when compensation is set to regulation adjustment (VOLT:COMP:MODE RADJ) and the output is on (OUTP ON).

Command

```
[SOURCE:]VOLTage:COMPensate:RADJust[:RATio] <numeric>
```

```
[SOURCE:]VOLTage:COMPensate:RADJust[:RATio]?
```

Parameter

Value: 0 to 10 Regulation adjustment ratio (The default value is 0)

Unit: PCT

Settings are reset to default values when an *RST command is sent.

Example

```
VOLT:COMP:RADJ 4.0
```

Response: NR3

VOLT:COMP:SOFT:CONT

Set the soft sensing control target.

This command is invalid when the output is on (OUTP ON).

Command

```
[SOURce:]VOLTage:COMPensate:SOFT:CONTrol[:STATus] <character>
```

```
[SOURce:]VOLTage:COMPensate:SOFT:CONTrol[:STATus]?
```

Parameter

Value:	AC	Corrects the AC voltage (default) This is invalid if the DC voltage is not set to 0 V.
	DC	Corrects the DC voltage This is invalid if the AC voltage is not set to 0 V.

Settings are reset to default values when an *RST command is sent.

Example

```
VOLT:COMP:SOFT:CONT AC
```

Response: Characters

VOLT:COMP:SOFT:TERM

Set the sensing point.

This command is invalid when the output is on (OUTP ON).

Command

```
[SOURCE:]VOLTage:COMPensate:SOFT:TERMinal <character>
```

```
[SOURCE:]VOLTage:COMPensate:SOFT:TERMinal?
```

Parameter

Value:	OUTPut	Output terminal (output voltage correction function)
	SENSing	Sensing terminal (load wire voltage drop correction function) (default)

Settings are reset to default values when an *RST command is sent.

Example

```
VOLT:COMP:SOFT:TERM OUTP
```

Response: Characters

VOLT:EXT:INP:EXTDC:ADJ:GAIN

Sets the gain for when the input waveform is amplified using an external analog signal.

This command is valid when the signal source is set to external signal source (VOLT:EXT:EXTDC:SIGN:SOUR EXT).

Command

```
[SOURce:]VOLTage:EXTernal:INPut:EXTDC:ADJust:GAIN <NRf_ch>,<NRf_gain>
```

```
[SOURce:]VOLTage:EXTernal:INPut:EXTDC:ADJust:GAIN? <NRf_ch>
```

Parameter <NRf_ch> Channel to be configured

Value:	0	Ch.A
	1	Ch.B
	2	Ch.C

Parameter <NRf_gain> Gain

Value: 5 to 220 (The default value is 100)

Settings are reset to default values when an *RST command is sent.

Example

```
VOLT:EXT:INP:EXTDC:ADJ:GAIN 0,10
```

Response: NR3

VOLT:EXT:INP:EXTDC:ADJ:OFFS

Sets the offset for when the input waveform is amplified using an external analog signal.

This command is valid when the signal source is set to external signal source (VOLT:EXT:EXTDC:SIGN:SOUR EXT).

Command

```
[SOURce:]VOLTage:EXTernal:INPut:EXTDC:ADJust:OFFSet <NRf_ch>,<NRf_offset>
```

```
[SOURce:]VOLTage:EXTernal:INPut:EXTDC:ADJust:OFFSet? <NRf_ch>
```

Parameter <NRf_ch> Channel to be configured

設定値 :	0	Ch.A
	1	Ch.B
	2	Ch.C

Parameter <NRf_offset> Offset

Value: -200 to 200(The default value is 0)

Settings are reset to default values when an *RST command is sent.

Example

```
VOLT:EXT:INP:EXTDC:ADJ:OFFS 0,10
```

Response: NR3

VOLT:EXT:INP:EXTDC:APER

Sets the measurement time for when the input waveform is amplified using an external analog signal.

This command is valid when the signal source is set to external signal source (VOLT:EXT:EXTDC:SIGN:SOUR EXT).

Command

```
[SOURce:]VOLTage:EXTernal:INPut:EXTDC:APERture <numeric>
```

```
[SOURce:]VOLTage:EXTernal:INPut:EXTDC:APERture?
```

Parameter

Value: 0.1 to 1.0 Measurement time (The default value is 0.1)

Unit: S

Settings are reset to default values when an *RST command is sent.

Example

```
VOLT:EXT:INP:EXTDC:APER 0.5
```

Response: NR3

VOLT:EXT:INP:EXTDC:SIGN:POL

Sets the signal polarity of each channel for when the input waveform is amplified using an external analog signal.

Command

```
[SOURce:]VOLTage:EXTernal:INPut:EXTDC:SIGNal:POLarity <NR1>,<character>
```

```
[SOURce:]VOLTage:EXTernal:INPut:EXTDC:SIGNal:POLarity? <NR1>
```

Parameter <NR1>

Value:	0	Channel A
	1	Channel B
	2	Channel C

Parameter <character>

Value:	NORMAL	Outputs a signal whose polarity is the same as the input signal (default)
	INVERTed	Outputs a signal whose polarity is opposite to that of the input signal.

Settings are reset to default values when an *RST command is sent.

Example

```
VOLT:EXT:INP:EXTDC:SIGN:POL 0,INV
```

```
VOLT:EXT:INP:EXTDC:SIGN:POL? 0
```

Response: Characters

VOLT:EXT:INP:EXTDC:SIGN:SOUR

Sets the signal source for when the input waveform is amplified using an external analog signal.

Command

```
[SOURce:]VOLTage:EXTernal:INPut:EXTDC:SIGNal:SOURce <character>
```

```
[SOURce:]VOLTage:EXTernal:INPut:EXTDC:SIGNal:SOURce?
```

Parameter

Value: EXTernal External signal (default)
 INT_EXT Internal signal and external signal

Settings are reset to default values when an *RST command is sent.

Example

```
VOLT:EXT:INP:EXTDC:SIGN:SOUR INT_EXT
```

Response: Characters

VOLT:EXT:INP:FUNC:MODE

Selects the parameter to control with the external analog signal.

This command is invalid when the output is on (OUTP ON).

Command

```
[SOURce:]VOLTage:EXTernal:INPut:FUNction:MODE <character>
```

```
[SOURce:]VOLTage:EXTernal:INPut:FUNction:MODE?
```

Parameter

Value:	OFF	Disables the use of the external analog signal (default)
	EXTDC	Amplifies the input waveform
	VPRogram	Varies the output voltage or frequency

Settings are reset to default values when an *RST command is sent.

Example

```
VOLT:EXT:INP:FUNC:MODE EXTDC
```

Response: Characters

VOLT:EXT:INP:VPR:ADJ:GAIN

Sets the gain for when varying the voltage or frequency with the external analog signal.

Command

```
[SOURce:]VOLTage:EXTernal:INPut:VPRogram:ADJust:GAIN <NRf_ch>,<NRf_gain>
```

```
[SOURce:]VOLTage:EXTernal:INPut:VPRogram:ADJust:GAIN? <NRf_ch>
```

Parameter <NRf_ch> Channel to be configured

設定値 :	0	Ch.A
	1	Ch.B
	2	Ch.C

Parameter <NRf_gain> Gain

Value: 5 to 50 (The default value is 10)

Settings are reset to default values when an *RST command is sent.

Example

```
VOLT:EXT:INP:VPR:ADJ:GAIN 0,10
```

Response: NR3

VOLT:EXT:INP:VPR:ADJ:OFFS

Sets the offset for when varying the voltage or frequency with the external analog signal.

Command

```
[SOURce:]VOLTage:EXTernal:INPut:VPRogram:ADJust:OFFSet <NRf_
ch>,<NRf_offset>
```

```
[SOURce:]VOLTage:EXTernal:INPut:VPRogram:ADJust:OFFSet? <NRf_ch>
```

Parameter <NRf_ch> Channel to be configured

設定値 :	0	Ch.A
	1	Ch.B
	2	Ch.C

Parameter <NRf_offset> Offset

Value: -200 to 200 (The default value is 0)

Settings are reset to default values when an *RST command is sent.

Example

```
VOLT:EXT:INP:VPR:ADJ:OFFS 0,10
```

Response: NR3

VOLT:EXT:INP:VPR:MAP

Sets the channel configuration for when varying the voltage or frequency with the external analog signal.

This command is invalid for single-phase output and single-phase three-wire output.

Command

```
[SOURce:]VOLTage:EXTernal:INPut:VPRogram:MAP <character>
```

```
[SOURce:]VOLTage:EXTernal:INPut:VPRogram:MAP?
```

Parameter

Value: ALL ChA: AC voltage, ChB: DC voltage, ChC: Frequency (default)
ACVoltage ChA: U phase AC voltage, ChB: V phase AC voltage,
ChC: W phase AC voltage
DCVoltage ChA: U phase DC voltage, ChB: V phase DC voltage,
ChC: W phase DC voltage

Settings are reset to default values when an *RST command is sent.

Example

```
VOLT:EXT:INP:VPR:MAP DCV
```

Response: Characters

VOLT:EXT:INP:VPR:STAT

Turns on or off the output of each channel for when varying the voltage or frequency with the external analog signal.

Command

```
[SOURce:]VOLTage:EXTernal:INPut:VPRogram:STATe <NRf>,<boolean>
```

```
[SOURce:]VOLTage:EXTernal:INPut:VPRogram:STATe? <NRf>
```

Parameter <NRf>

Value: 0 Channel A
 1 Channel B
 2 Channel C

Parameter <boolean>

Value: ON(1) Output on
 OFF(0) Output off (default)

Settings are reset to default values when an *RST command is sent.

Example

```
VOLT:EXT:INP:VPR:STAT 0,ON
```

Response: NR1

VOLT:LIM:LOW

Sets the lower AC voltage limit.

If the signal source is set to external signal source (VOLT:EXT:EXTDC:SIGN:SOUR EXT), this command is invalid.

The following relationship must be met: $VOLT:LIM:LOW \leq VOLT|VOLT:TRIG \leq VOLT:LIM:UPP$

Command

```
[SOURce:]VOLTage[:LEVel]LIMit:LOWer <numeric>
```

```
[SOURce:]VOLTage[:LEVel]LIMit:LOWer?
```

Parameter

Value: 0 to 322.0 Lower AC voltage limit (The default value is 0)

Unit: V

Settings are reset to default values when an *RST command is sent.

Example

```
VOLT:LIM:LOW 119
```

Response: NR3

VOLT:LIM:UPP

Sets the upper AC voltage limit.

This command is valid for AC output.

If the signal source is set to external signal source (VOLT:EXT:EXTDC:SIGN:SOUR EXT), this command is invalid.

The following relationship must be met: VOLT:LIM:LOW \leq VOLT|VOLT:TRIG \leq VOLT:LIM:UPP

Command

```
[SOURCE:]VOLTage[:LEVel]:LIMit:UPPer <numeric>
```

```
[SOURCE:]VOLTage[:LEVel]:LIMit:UPPer?
```

Parameter

Value: 0 to 322.0 Upper AC voltage limit (The default value is 322.0)

Unit: V

Settings are reset to default values when an *RST command is sent.

Example

```
VOLT:LIM:UPP 121
```

Response: NR3

VOLT:LTL

Sets the line AC voltage.

This command is valid for single-phase three-wire output.

This command is valid during three-phase output when the U-V phase difference is 120 (SYST:CONF:PHAS:UV 120) and the U-W phase difference is 240 (SYST:CONF:PHAS:UW 240).

This command is valid during two-phase output when the U-V phase difference is 180 (SYST:CONF:PHAS:UV 180).

If the signal source is set to external signal source (VOLT:EXT:EXTDC:SIGN:SOUR EXT), this command is invalid.

This command is invalid when an external analog signal is used to control the voltage or frequency (VOLT:EXT:FUNC:MODE VPR).

Command

```
[SOURce:]VOLTage:LTLLine <numeric>
```

```
[SOURce:]VOLTage:LTLLine?
```

Parameter

Value: 0 to 322.0 Line AC voltage in the single-phase three-wire output/ two-phase output L range
0 to 644.0 Line AC voltage in the single-phase three-wire output/ two-phase output H range
0 to 278.8 Line AC voltage in the three-phase output L range
0 to 557.7 Line AC voltage in the three-phase output H range
(The default value is 0.)

Unit: V

Settings are reset to default values when an *RST command is sent.

Example

```
VOLT:LTL 173.0
```

Response: NR3

Returns +9.91E+37 in the case of unbalanced phase or unbalanced voltage.

VOLT:OFFS

Sets the DC voltage.

This command is invalid when the combined value with the AC voltage is outside the allowable range (L range: -227.5 V to 227.5 V, H range: -455.0 V to 455.0 V).

If the signal source is set to external signal source (VOLT:EXT:EXTDC:SIGN:SOUR EXT), this command is invalid.

For single-phase three-wire output, set the U phase voltage. The V phase is automatically outputs to the same value as the U phase but with reverse polarity.

Command

```
[SOURce:]VOLTage:OFFSet[:IMMediate] <numeric>[, (@chanlist)]
[SOURce:]VOLTage:OFFSet[:IMMediate]? [(@chanlist)]
```

Parameter

Value: -227.5 to +227.5 DC voltage in the L range
 -455.0 to +455.0 DC voltage in the H range
 (The default value is 0.)

Unit: V

Settings are reset to default values when an *RST command is sent.

Example

```
VOLT:OFFS -10.5
```

Response: NR3

Response

VOLT:OFFS:LIM:LOW

Sets the lower DC voltage limit.

If the signal source is set to external signal source (VOLT:EXT:EXTDC:SIGN:SOUR EXT), this command is invalid.

For single-phase three-wire, set this value with the phase voltage of phase U.

The following relationship must be met: $VOLT:OFFS:LIM:LOW \leq VOLT:OFFS|-VOLT:OFFS:TRIG \leq VOLT:OFFS:LIM:UPP$

Command

```
[SOURce:]VOLTage:OFFSet:LIMit:LOWer <numeric>
```

```
[SOURce:]VOLTage:OFFSet:LIMit:LOWer?
```

Parameter

Value: -455.0 to +455.0 Lower DC voltage limit (The default value is -455.0)

Unit: V

Settings are reset to default values when an *RST command is sent.

Example

```
VOLT:OFFS:LIM:LOW -12
```

Response: NR3

VOLT:OFFS:LIM:UPP

Sets the upper DC voltage limit.

If the signal source is set to external signal source (VOLT:EXT:EXTDC:SIGN:SOUR EXT), this command is invalid.

For single-phase three-wire, set this value with the phase voltage of phase U.

The following relationship must be met: VOLT:OFFS:LIM:LOW \leq VOLT:OFFS|VOLT:OFFS:TRIG \leq VOLT:OFFS:LIM:UPP

Command

```
[SOURCE:]VOLTage:OFFSet:LIMit:UPPer <numeric>
```

```
[SOURCE:]VOLTage:OFFSet:LIMit:UPPer?
```

Parameter

Value: -455.0 to +455.0 Upper DC voltage limit (The default value is 455.0)

Unit: V

Settings are reset to default values when an *RST command is sent.

Example

```
VOLT:OFFS:LIM:UPP -9
```

Response: NR3

VOLT:OFFS:LTL

Sets the line DC voltage.

This command is valid for single-phase three-wire output.

If the signal source is set to external signal source (VOLT:EXT:EXTDC:SIGN:SOUR EXT), this command is invalid.

Command

```
[SOURce:]VOLTage:OFFSet:LTLIne <numeric>
```

```
[SOURce:]VOLTage:OFFSet:LTLIne?
```

Parameter

Value: -455.0 to +455.0 Line DC voltage in the L range
 -910.0 to +910.0 Line DC voltage in the H range
 (The default value is 0.)

Unit: V

Settings are reset to default values when an *RST command is sent.

Example

```
VOLT:OFFS:LTL +50
```

Response: NR3

Returns +9.91E+37 in the case of unbalanced phase or unbalanced voltage.

VOLT:OFFS:TRIG

Sets the DC voltage to change to when INIT:TRAN or a software trigger is sent.

This command is invalid when the combined value with the AC voltage is outside the allowable range (L range: -227.5 V to 227.5 V, H range: -455.0 V to 455.0 V).

If the signal source is set to external signal source (VOLT:EXT:EXTDC:SIGN:SOUR EXT), this command is invalid.

Command

```
[SOURce:]VOLTage:OFFSet:TRIGgered <numeric>[, (@chanlist)]
```

```
[SOURce:]VOLTage:OFFSet:TRIGgered?
```

Parameter

Value: -227.5 to +227.5 DC voltage in the L range
 -455.0 to +455.0 DC voltage in the H range
 (The default value is 0.)

Unit: V

Settings are reset to default values when an *RST command is sent.

Example

```
VOLT:OFFS:TRIG -10.5
```

Response: NR3

VOLT:PROT:LOW

Sets the UVP value.

For single-phase three-wire output and three-phase output, set the limits using phase voltages.

This command is valid when using the UVP function (VOLT:PROT:LOW:STAT ON).

Command

```
[SOURce:]VOLTage:PROTection:LOWer <numeric>
```

```
[SOURce:]VOLTage:PROTection:LOWer?
```

Parameter

Value: 0 to +500.5 UVP value (The default value is 0)

Unit: V

Settings are reset to default values when an *RST command is sent.

Example

```
VOLT:PROT:LOW 120.0
```

Response: NR3

VOLT:PROT:PEAK:LOW

Sets the negative peak OVP value.

Command

```
[SOURce:]VOLTage:PROTection:PEAK:LOWer <numeric>
```

```
[SOURce:]VOLTage:PROTection:PEAK:LOWer?
```

Parameter

Value: -500.5 to -14.0 (The default value is -500.5.)

Unit: V

Settings are reset to default values when an *RST command is sent.

Example

```
VOLT:PROT:PEAK:LOW -120.0
```

Response: NR3

VOLT:PROT:PEAK:UPP

Sets the positive peak OVP value.

Command

```
[SOURce:]VOLTage:PROTection:PEAK:UPPer <numeric>
```

```
[SOURce:]VOLTage:PROTection:PEAK:UPPer?
```

Parameter

Value: 14.0 to 500.5 (The default value is 500.5.)

Unit: V

Settings are reset to default values when an *RST command is sent.

Example

```
VOLT:PROT:PEAK:UPP 120.0
```

Response: NR3

VOLT:PROT:LOW:STAT

Enables/disables UVP.

Use VOLT:PROT:LOW to set the UVP value.

Command

```
[SOURCE:]VOLTage:PROTection:LOWer:STATe <boolean>
```

```
[SOURCE:]VOLTage:PROTection:LOWer:STATe?
```

Parameter

Value: ON(1) Enables the UVP
 OFF(0) Disables the UVP (default)

Settings are reset to default values when an *RST command is sent.

Example

```
VOLT:PROT:LOW:STAT ON
```

Response: NR1

VOLT:PROT:UPP

Sets the OVP (rms) value.

For single-phase three-wire output and three-phase output, set the limits using phase voltages.

Command

```
[SOURce:]VOLTage:PROTection:UPPer <numeric>
```

```
[SOURce:]VOLTage:PROTection:UPPer?
```

Parameter

Value: 14.0 to 500.5 OVP value (The default value is 500.5)

Unit: V

Settings are reset to default values when an *RST command is sent.

Example

```
VOLT:PROT:UPP 120.0
```

Response: NR3

VOLT:RANG

Sets the voltage range.

If the AC voltage and DC voltage (including the value changed by a trigger) are set within the H range, the voltage range cannot be set to L range.

This command is invalid when the output is on (OUTP ON).

Command

```
[SOURce:]VOLTage:RANGe[:UPPer] <numeric>
```

```
[SOURce:]VOLTage:RANGe[:UPPer]?
```

Parameter

Value:	161	L range (default)
	322	H range

Settings are reset to default values when an *RST command is sent.

Example

```
VOLT:RANG 322
```

Response: NR3

VOLT:RESP

Sets the response speed.

This command is invalid when the output is on (OUTP ON).

This command is invalid when a voltage abnormality simulation or a sequence is running.

Command

```
[SOURce:]VOLTage:RESPonse <character>
```

```
[SOURce:]VOLTage:RESPonse?
```

Parameter

Value:	SLOW	High stability
	MEDium	Normal speed (default)
	FAST	High-speed response. This is invalid for parallel connection.

Settings are reset to default values when an *RST command is sent.

Example

```
VOLT:RESP MED
```

Response: Characters

VOLT:TRIG

Sets the AC voltage to change to when INIT:TRAN or a software trigger is sent.

This command is valid for AC output.

This command is invalid when the combined value with the DC voltage is outside the allowable range (L range: -227.5 V to 227.5 V, H range: -455.0 V to 455.0 V).

Command

```
[SOURce:]VOLTage[:LEVel]:TRIGgered[:AMPLitude] <numeric>[, (@chan-  
list)]
```

```
[SOURce:]VOLTage[:LEVel]:TRIGgered[:AMPLitude]?
```

Parameter

Value: 0 to 162.0 AC voltage in the L range
0 to 322.0 AC voltage in the H range
(The default value is 0.)

Unit: V

Settings are reset to default values when an *RST command is sent.

Example

```
VOLT:TRIG 120
```

Response: NR3

STATUS Command

Status Report Structure

A "+" represents the logical OR of the register bits.

Single-phase output

1999 SCPI Syntax & Style

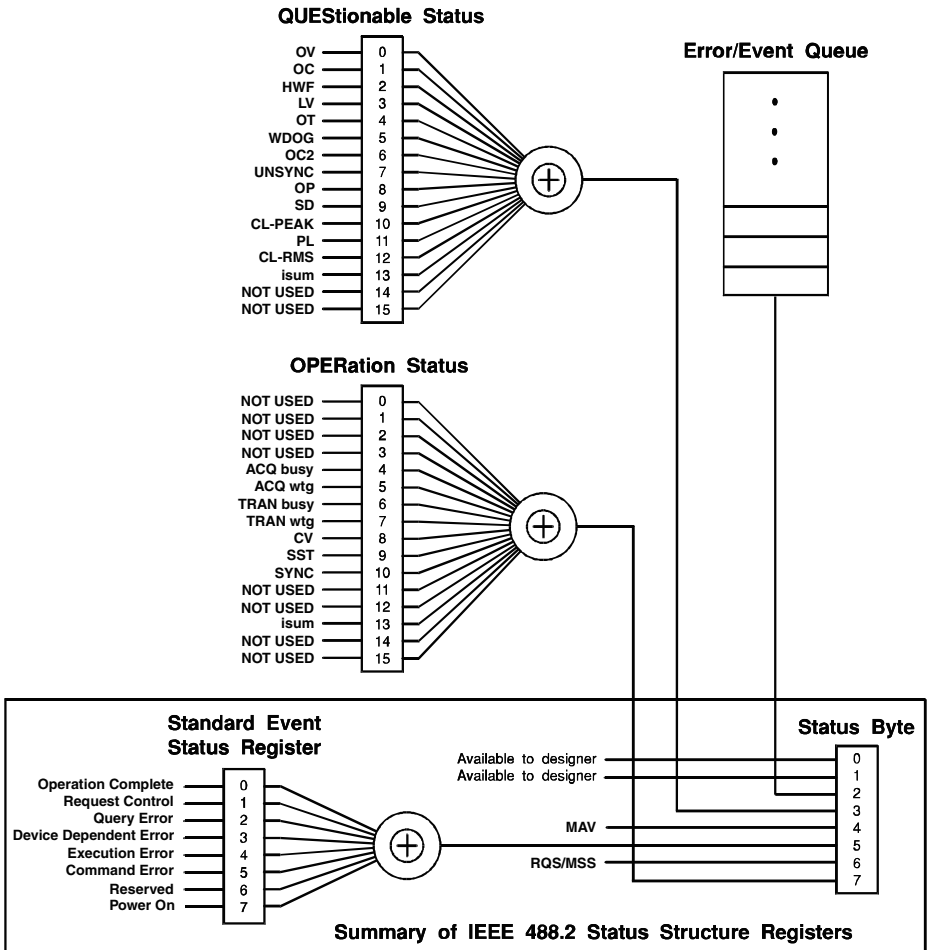

Single-phase three-wire output and three-phase output

The OPERation Status, OPERation:INSTRument Status, and OPERation:INSTRument:ISUMmary Status registers all operate the same way.

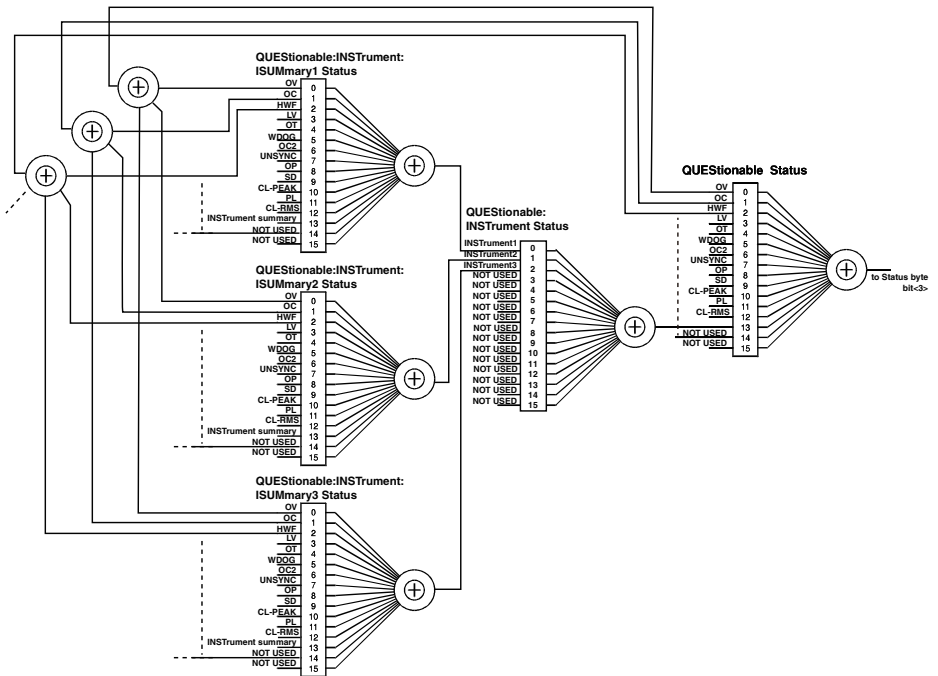

Architecture

IEEE 488.2 and SCPI registers are used for status reports.

In each SCPI status register, there are the following sub registers: the CONDition register, the EVENT register, the ENABLE register, the PTRansition filter, and the NTRansition filter.

CONDition register

Transitions of the CONDition register are automatic and reflect the condition of the product in real time. Reading this register does not affect its contents.

EVENT register

The EVENT register bits are automatically set according to the changes in the CONDition register. The rule for setting the bits varies depending on the positive and negative transition registers (PTRansition and NTRansition). The EVENT register is reset when it is read.

ENABLE register

The ENABLE register enables reports to the summary bit or status bit of the event bits.

Transition filters

Use the PTRansition (positive transition) filter to report events when the condition changes from false to true.

Use the NTRansition (negative transition) filter to report events when the condition changes from true to false.

If both the positive filter and negative filter are set to true, events can be reported each time the status changes.

If both filters are cleared, event reporting is disabled.

Status byte register

The status byte register stores STB and RQS (MSS) messages as defined by the IEEE 488.1 standard. The status byte register can be read by using IEEE 488.1 serial polling or the IEEE 488.2 common command *STB?.

When the controller executes serial polling, bit 6 responds with request service (RQS). The status byte value is not changed by serial polling.

*STB? makes the device transmit the contents of the status byte register and the master status summary (MSS) message.

*STB? does not change the status byte, MSS, and RQS.

Bit	Bit weight	Bit name	Description
0	1	Reserved	Reserved for future use by IEEE 488. The bit value is notified as zero.
1	2	Reserved	
2	4	Error/Event Queue	If data exists in the error or event queue, this bit is set to true.
3	8	Questionable Status Register (QUES)	This bit is set to true when a bit is set in the QUESTIONable event status register and the corresponding bit in the QUESTIONable status enable register is true.
4	16	Message Available (MAV)	This bit is set to true when a request is received from the digital programming interface and the product is ready to generate the data byte.
5	32	Standard Event Status Bit Summary (ESB)	This bit is set to true when a bit is set in the event status register.
6	64	Request Service (RQS)	This bit is set to true when a bit is set in the service request enable register and the corresponding bit exists in the status byte. The SRQ line of the GPIB is set.
		Master Status Summary (MSS)	This bit is set to true when any bit in the status byte register is set to 1 and the corresponding bit in the service request enable register is set to 1.
7	128	Operation Status Register (OPER)	This bit is set to true when a bit is set in the OPERATION event status register and the corresponding bit in the OPERATION status enable register is set.
8-15		Not Used	Not used

Event status register

The event status register bits are set when certain events occur during product operation. All the event status register bits are set by the error event queue.

This register is defined by the IEEE 488.2 standard and is controlled using the IEEE 488.2 common commands *ESE, *ESE?, and *ESR?.

You can check the error content with SYST:ERR?.

Bit	Bit weight	Bit name	Description	Error number
0	1	Operation Complete(OPC)	Set when an *OPC command is received and all operations in standby have been completed.	-800 to -899
1	2	Request Control (RQC)	Not used	--
2	4	Query Error(QYE)	Set when an attempt is made to read data from the output queue when there is no data or when the output queue is not in the wait state. This indicates that there is no data in the output queue.	-400 to -499
3	8	Device Dependent Error(DDE)	Set when there is a device-specific error.	-300 to -399 100 to 999
4	16	Execution Error(EXE)	Set when the product evaluates that the program data after the header is outside the formal input range or does not match the specifications of the product. This indicates that a valid SCPI command may not be executed correctly depending on the state of the product.	-200 to -299
5	32	Command Error(C-ME)	Set when an IEEE 488.2 syntax error is detected by the parser, when an unidentifiable header is received, or when a group execution trigger enters the internal IEEE 488.2 SCPI command input buffer.	-100 to -199
6	64	Reserved	Not used	--
7	128	PON	Set when the power is turned on.	--
8-15		Reserved	Not used	--

OPERation status register

The OPERation status register is a 16-bit register that contains information about the normal operating conditions of the product.

Bit	Bit weight	Bit name	Description
0	1	NOT USED	Not used
1	2	NOT USED	Not used
2	4	NOT USED	Not used
3	8	NOT USED	Not used
4	16	ACQ busy	Indicates whether measurement is in progress on the PCR.
5	32	ACQ wtg	Indicates whether the product is waiting for a measurement trigger (TRIG).
6	64	TRAN busy	Indicates whether the product is running a sequence or a power line abnormality simulation or changing the settings.
7	128	TRAN wtg	Indicates whether the product is waiting for a trigger (TRIG) for running a sequence or a power line abnormality simulation or changing the settings.
8	256	CV	CV output
9	512	SST	Indicates whether a soft start is being performed.
10	1024	SYNC	Indicates whether the synchronization function is in operation.
11	2048	NOT USED	Not used
12	4096	NOT USED	Not used
13	8192	INSTrument Summary	Summary bit of the OPERation:INSTrument subregister
14	16384	NOT USED	Not used
15	32768	NOT USED	Always 0.

STAT:OPER

Queries the event of the OPERATION status register.

A query clears the contents of the register.

Command

```
STATus:OPERation[:EVENT]?
```

Response: NR1

STAT:OPER:COND

Queries the condition of the OPERation status register.

A query does not clear the contents of the register.

Command

```
STATus:OPERation:CONDition?
```

Response: NR1

STAT:OPER:ENAB

Sets the enable register of the OPERation status register.

Command

```
STATus:OPERation:ENABle <NR1>
```

```
STATus:OPERation:ENABle?
```

Parameter

Value: 0 to 65535 (The default value is 0)

Response: NR1

STAT:OPER:NTR

Sets the negative transition filter of the OPERation status register.

Command

```
STATus:OPERation:NTRansition <NR1>
```

```
STATus:OPERation:NTRansition?
```

Parameter

Value: 0 to 65535 (The default value is 0)

Response: NR1

STAT:OPER:PTR

Sets the positive transition filter of the OPERation status register.

Command

```
STATus:OPERation:PTRansition <NR1>
```

```
STATus:OPERation:PTRansition?
```

Parameter

Value: 0 to 65535 (The default value is 32767)

Response: NR1

OPERation:INSTrument subregister

This is the subregister (16 bits) of bit 13 of the OPERation status register.

Bit	Bit weight	Bit name	Description
0	1	INSTrument1	U phase (OPER:INST:ISUM1) summary bit
1	2	INSTrument2	V phase (OPER:INST:ISUM2) summary bit
2	4	INSTrument3	W phase (OPER:INST:ISUM3) summary bit
3	8	NOT USED	Not used
4	16	NOT USED	Not used
5	32	NOT USED	Not used
6	64	NOT USED	Not used
7	128	NOT USED	Not used
8	256	NOT USED	Not used
9	512	NOT USED	Not used
10	1024	NOT USED	Not used
11	2048	NOT USED	Not used
12	4096	NOT USED	Not used
13	8192	NOT USED	Not used
14	16384	NOT USED	Not used
15	32768	NOT USED	Always 0

STAT:OPER:INST

Queries the event of the OPERation:INSTrument subregister.

A query clears the contents of the register.

Command

```
STATus:OPERation:INSTrument[:EVENT]?
```

Response: NR1

STAT:OPER:INST:COND

Queries the condition of the OPERation:INSTRument subregister.

A query does not clear the contents of the register.

Command

```
STATus:OPERation:INSTRument:CONDition?
```

Response: NR1

STAT:OPER:INST:ENAB

Sets the enable register of the OPERation:INSTrument subregister.

Command

```
STATus:OPERation:INSTrument:ENABle <NR1>
```

```
STATus:OPERation:INSTrument:ENABle?
```

Parameter

Value: 0 to 65535 (The default value is 0)

Response: NR1

STAT:OPER:INST:NTR

Sets the negative transition filter of the OPERation:INSTRument subregister.

Command

```
STATus:OPERation:INSTRument:NTRansition <NR1>
```

```
STATus:OPERation:INSTRument:NTRansition?
```

Parameter

Value: 0 to 65535 (The default value is 0)

Response: NR1

STAT:OPER:INST:PTR

Sets the positive transition filter of the OPERation:INSTrument subregister.

Command

```
STATus:OPERation:INSTrument:PTRansition <NR1>
```

```
STATus:OPERation:INSTrument:PTRansition?
```

Parameter

Value: 0 to 65535 (The default value is 32767)

Response: NR1

OPERation:INSTRument:ISUMmary{1|2|3} subregister

This is the subregister of bits 1 to 3 of the OPERation:INSTRument subregister. This is a 16-bit register that contains information about the normal operating conditions of the product for each phase.

Of the parameters {1|2|3}, 1 represents U phase, 2 represents V phase, and 3 represents W phase.

Bit	Bit weight	Bit name	Description
0	1	NOT USED	Not used
1	2	NOT USED	Not used
2	4	NOT USED	Not used
3	8	NOT USED	Not used
4	16	ACQ busy	Indicates whether measurement is in progress on the PCR.
5	32	ACQ wtg	Indicates whether the product is waiting for a measurement trigger (TRIG).
6	64	TRAN busy	Indicates whether the product is running a sequence or a power line abnormality simulation or changing the settings.
7	128	TRAN wtg	Indicates whether the product is waiting for a trigger (TRIG) for running a sequence or a power line abnormality simulation or changing the settings.
8	256	CV	CV output
9	512	SST	Indicates whether a soft start is being performed.
10	1024	SYNC	Indicates whether the synchronization function is in operation.
11	2048	NOT USED	Not used
12	4096	NOT USED	Not used
13	8192	INSTRument Summary	Not used
14	16384	NOT USED	Not used
15	32768	NOT USED	Always 0.

STAT:OPER:INST:ISUM{1|2|3}

Queries the event of the OPERATION:INSTRUMENT:ISUMmary{1|2|3} subregister.

This command is valid for single-phase three-wire output and three-phase output.

A query clears the contents of the register.

Of the parameters {1|2|3}, 1 represents U phase, 2 represents V phase, and 3 represents W phase.

Command

U phase

```
STATus:OPERation:INSTRument:ISUMmary1 [:EVENT]?
```

V phase

```
STATus:OPERation:INSTRument:ISUMmary2 [:EVENT]?
```

W phase (three-phase output only)

```
STATus:OPERation:INSTRument:ISUMmary3 [:EVENT]?
```

Response: NR1

STAT:OPER:INST:ISUM{1|2|3}:COND

Queries the condition of the OPERation:INSTrument:ISUMmary{1|2|3} subregister.

This command is valid for single-phase three-wire output and three-phase output.

A query does not clear the contents of the register.

Of the parameters {1|2|3}, 1 represents U phase, 2 represents V phase, and 3 represents W phase.

Command

U phase

```
STATus:OPERation:INSTrument:ISUMmary1:CONDition?
```

V phase

```
STATus:OPERation:INSTrument:ISUMmary2:CONDition?
```

W phase (three-phase output only)

```
STATus:OPERation:INSTrument:ISUMmary3:CONDition?
```

Response: NR1

STAT:OPER:INST:ISUM{1|2|3}:ENAB

Sets the enable register of the OPERation:INSTrument:ISUMmary{1|2|3} subregister.

This command is valid for single-phase three-wire output and three-phase output.

Command

U phase

```
STATus:OPERation:INSTrument:ISUMmary1:ENABle <NRf>
```

```
STATus:OPERation:INSTrument:ISUMmary1:ENABle?
```

V phase

```
STATus:OPERation:INSTrument:ISUMmary2:ENABle <NRf>
```

```
STATus:OPERation:INSTrument:ISUMmary2:ENABle?
```

W phase (three-phase output only)

```
STATus:OPERation:INSTrument:ISUMmary3:ENABle <NRff>
```

```
STATus:OPERation:INSTrument:ISUMmary3:ENABle?
```

Parameter

Value: 0 to 65535 (The default value is 0)

Response: NR1

STAT:OPER:INST:ISUM{1|2|3}:NTR

Sets the negative transition filter of the OPERation:INSTrument:ISUMmary{1|2|3} subregister.

This command is valid for single-phase three-wire output and three-phase output.

Command**U phase**

```
STATus:OPERation:INSTrument:ISUMmary1:NTRansition <NRf>
STATus:OPERation:INSTrument:ISUMmary1:NTRansition?
```

V phase

```
STATus:OPERation:INSTrument:ISUMmary2:NTRansition <NRf>
STATus:OPERation:INSTrument:ISUMmary2:NTRansition?
```

W phase (three-phase output only)

```
STATus:OPERation:INSTrument:ISUMmary3:NTRansition <NRf>
STATus:OPERation:INSTrument:ISUMmary3:NTRansition?
```

Parameter

Value: 0 to 65535 (The default value is 0)

Response: NR1

STAT:OPER:INST:ISUM{1|2|3}:PTR

Sets the positive transition filter of the OPERATION:INSTRUMENT:ISUMmary{1|2|3} sub-register.

This command is valid for single-phase three-wire output and three-phase output.

Command

U phase

```
STATus:OPERation:INSTRument:ISUMmary1:PTRansition <Nrf>
```

```
STATus:OPERation:INSTRument:ISUMmary1:PTRansition?
```

V phase

```
STATus:OPERation:INSTRument:ISUMmary2:PTRansition <Nrf>
```

```
STATus:OPERation:INSTRument:ISUMmary2:PTRansition?
```

W phase (three-phase output only)

```
STATus:OPERation:INSTRument:ISUMmary3:PTRansition <Nrf>
```

```
STATus:OPERation:INSTRument:ISUMmary3:PTRansition?
```

Parameter

Value: 0 to 65535 (The default value is 32767)

Response: NR1

QUESTIONable status register

The QUESTIONable status register is a 16-bit register that stores information related to the product’s status and the questionable events that occur during product operation.

The QUESTIONable status register bits may indicate that there are problems with the product’s measured data.

Bit	Bit weight	Bit name	Description
0	1	OV (Over Voltage Protection)	Overvoltage protection activated
1	2	OC (Over Current Protection)	Overcurrent protection activated
2	4	HWF (Hardware Failure)	Device error occurred
3	8	LV (Low Voltage Protection)	Undervoltage protection activated
4	16	OT (Over Temperature Protection)	Overheat protection activated
5	32	WDOG (Watchdog protection)	Communication monitoring activated
6	64	OC2 (Over Current Protection)	Overcurrent internal semiconductor protection activated
7	128	UNSYNC (FREQUENCY synchronisation fault)	Sync function error occurred
8	256	OP (Over Power protection)	Overpower protection activated
9	512	SD (SHUTDOWN)	Forced output shutdown
10	1024	CL-PEAK (Current Limit on PEAK)	Current limit control activated
11	2048	PL(Power Limit)	Power limit activated
12	4096	CL-RMS(Current Limit on RMS)	TRIP ENABLE: Overload judgment in progress TRIP DISABL: Output voltage control in progress
13	8192	INSTRument Summary	Summary bit of the QUESTIONable:INSTRument subregister
14	16384	Not Used	Not used
15	32768	Not Used	Always 0.

STAT:QUES

Queries the event of the QUEStionable status register.

A query clears the contents of the register.

Command

```
STATus:QUEStionable[:EVENT]?
```

Response: NR1

STAT:QUES:COND

Queries the condition of the QUEStionable status register.

A query does not clear the contents of the register.

Command

```
STATus:QUEStionable:CONDition?
```

Response: NR1

STAT:QUES:ENAB

Sets the enable register of the QUEStionable status register.

Command

```
STATus:QUEStionable:ENABle <NR1>
```

```
STATus:QUEStionable:ENABle?
```

Parameter

Value: 0 to 65535 (The default value is 0)

Response: NR1

STAT:QUES:NTR

Sets the negative transition filter of the QUEStionable status register.

Command

```
STATus:QUEStionable:NTRansition <NR1>
```

```
STATus:QUEStionable:NTRansition?
```

Parameter

Value: 0 to 65535 (The default value is 0)

Response: NR1

STAT:QUES:PTR

Sets the positive transition filter of the QUESTIONable status register.

Command

```
STATus:QUEStionable:PTRansition <NR1>
```

```
STATus:QUEStionable:PTRansition?
```

Parameter

Value: 0 to 65535 (The default value is 32767)

Response: NR1

QUESTionable:INSTrument subregister

This is the subregister (16 bits) of bit 13 of the QUESTionable status register.

Bit	Bit weight	Bit name	Description
0	1	INSTrument1	U phase (QUES:INST:ISUM1) summary bit
1	2	INSTrument2	V phase (QUES:INST:ISUM2) summary bit
2	4	INSTrument3	W phase (QUES:INST:ISUM3) summary bit
3	8	NOT USED	Not used
4	16	NOT USED	Not used
5	32	NOT USED	Not used
6	64	NOT USED	Not used
7	128	NOT USED	Not used
8	256	NOT USED	Not used
9	512	NOT USED	Not used
10	1024	NOT USED	Not used
11	2048	NOT USED	Not used
12	4096	NOT USED	Not used
13	8192	NOT USED	Not used
14	16384	NOT USED	Not used
15	32768	NOT USED	Always 0

STAT:QUES:INST

Queries the event of the QUEStionable:INSTrument subregister.

A query clears the contents of the register.

Command

```
STATus:QUEStionable:INSTrument[:EVENT]?
```

Response: NR1

STAT:QUES:INST:COND

Queries the condition of the QUESTIONable:INSTRument subregister.

A query does not clear the contents of the register.

Command

```
STATus:QUEStionable:INSTrument:CONDition?
```

Response: NR1

STAT:QUES:INST:ENAB

Sets the enable register of the QUEStionable:INSTrument subregister.

Command

```
STATus:QUEStionable:INSTrument:ENABle <NR1>
```

```
STATus:QUEStionable:INSTrument:ENABle?
```

Parameter

Value: 0 to 65535 (The default value is 0)

Response: NR1

STAT:QUES:INST:NTR

Sets the negative transition filter of the QUESTIONable:INSTrument subregister.

Command

```
STATus:QUEStionable:INSTrument:NTRansition <NR1>
```

```
STATus:QUEStionable:INSTrument:NTRansition?
```

Parameter

Value: 0 to 65535 (The default value is 0)

Response: NR1

STAT:QUES:INST:PTR

Sets the positive transition filter of the QUESTIONable:INSTrument subregister.

Command

```
STATus:QUEStionable:INSTrument:PTRansition <NR1>
```

```
STATus:QUEStionable:INSTrument:PTRansition?
```

Parameter

Value: 0 to 65535 (The default value is 32767)

Response: NR1

QUESTIONable:INSTrument:ISUMmary{1|2|3} subregister

This is the subregister of bits 1 to 3 of the QUESTIONable:INSTrument subregister. This is a 16-bit register that contains information about the product’s questionable events and status that occur during operation for each phase.

Of the parameters {1|2|3}, 1 represents U phase, 2 represents V phase, and 3 represents W phase.

The QUESTIONable status register bits may indicate that there are problems with the product’s measured data.

Bit	Bit weight	Bit name	Description
0	1	OV (Over Voltage Protection)	Overvoltage protection activated
1	2	OC (Over Current Protection)	Overcurrent protection activated
2	4	HWF (Hardware Failure)	Device error occurred
3	8	LV (Low Voltage Protection)	Undervoltage protection activated
4	16	OT (Over Temperature Protection)	Overheat protection activated
5	32	WDOG (Watchdog protection)	Communication monitoring activated
6	64	OC2 (Over Current Protection#2)	Overcurrent internal semiconductor protection activated
7	128	UNSYNC (FREQUENCY synchronisation fault)	Sync function error occurred
8	256	OP (Over Power protection)	Overpower protection activated
9	512	SD (SHUTDOWN)	Forced output shutdown
10	1024	CL-PEAK (Current Limit on PEAK)	Current limit control activated
11	2048	PL(Power Limit)	Power limit activated
12	4096	CL-RMS(Current Limit on RMS)	TRIP ENABLE: Overload judgment in progress TRIP DISABL: Output voltage control in progress
13	8192	INSTrument Summary	Not used
14	16384	Not Used	Not used
15	32768	Not Used	Always 0.

STAT:QUES:INST:ISUM{1|2|3}

Queries the event of the QUESTIONable:INSTrument:ISUMmary{1|2|3} subregister.

This command is valid for single-phase three-wire output and three-phase output.

A query clears the contents of the register.

Of the parameters {1|2|3}, 1 represents U phase, 2 represents V phase, and 3 represents W phase.

Command

U phase

```
STATus:QUEStionable:INSTrument:ISUMmary1[:EVENT]?
```

V phase

```
STATus:QUEStionable:INSTrument:ISUMmary2[:EVENT]?
```

W phase (three-phase output only)

```
STATus:QUEStionable:INSTrument:ISUMmary3[:EVENT]?
```

Response: NR1

STAT:QUES:INST:ISUM{1|2|3}:COND

Queries the condition of the QUESTIONable:INSTrument:ISUMmary{1|2|3} subregister.

This command is valid for single-phase three-wire output and three-phase output.

A query does not clear the contents of the register.

Of the parameters {1|2|3}, 1 represents U phase, 2 represents V phase, and 3 represents W phase.

Command

U phase

```
STATus:QUEStionable:INSTrument:ISUMmary1:CONDition?
```

V phase

```
STATus:QUEStionable:INSTrument:ISUMmary2:CONDition?
```

W phase (three-phase output only)

```
STATus:QUEStionable:INSTrument:ISUMmary3:CONDition?
```

Response: NR1

STAT:QUES:INST:ISUM{1|2|3}:ENAB

Sets the enable register of the QUESTIONable:INSTrument:ISUMmary{1|2|3} subregister.

This command is valid for single-phase three-wire output and three-phase output.

Command

U phase

```
STATus:QUESTionable:INSTrument:ISUMmary1:ENABle <Nrf>
```

```
STATus:QUESTionable:INSTrument:ISUMmary1:ENABle?
```

V phase

```
STATus:QUESTionable:INSTrument:ISUMmary2:ENABle <Nrf>
```

```
STATus:QUESTionable:INSTrument:ISUMmary2:ENABle?
```

W phase (three-phase output only)

```
STATus:QUESTionable:INSTrument:ISUMmary3:ENABle <Nrf>
```

```
STATus:QUESTionable:INSTrument:ISUMmary3:ENABle?
```

Parameter

Value: 0 to 65535 (The default value is 0)

Response: NR1

STAT:QUES:INST:ISUM{1|2|3}:NTR

Sets the negative transition filter of the QUESTIONable:INSTRument:ISUMmary{1|2|3} subregister.

This command is valid for single-phase three-wire output and three-phase output.

Command**U phase**

```
STATus:QUESTIONable:INSTRument:ISUMmary1:NTRansition <NRf>
```

```
STATus:QUESTIONable:INSTRument:ISUMmary1:NTRansition?
```

V phase

```
STATus:QUESTIONable:INSTRument:ISUMmary2:NTRansition <NRf>
```

```
STATus:QUESTIONable:INSTRument:ISUMmary2:NTRansition?
```

W phase (three-phase output only)

```
STATus:QUESTIONable:INSTRument:ISUMmary3:NTRansition <NRf>
```

```
STATus:QUESTIONable:INSTRument:ISUMmary3:NTRansition?
```

Parameter

Value: 0 to 65535 (The default value is 0)

Response: NR1

STAT:QUES:INST:ISUM{1|2|3}:PTR

Sets the positive transition filter of the QUESTIONable:INSTRument:ISUMmary{1|2|3} subregister.

This command is valid for single-phase three-wire output and three-phase output.

Command

U phase

```
STATus:QUESTionable:INSTRument:ISUMmary1:PTRansition <NR1>
```

```
STATus:QUESTionable:INSTRument:ISUMmary1:PTRansition?
```

V phase

```
STATus:QUESTionable:INSTRument:ISUMmary2:PTRansition <NR1>
```

```
STATus:QUESTionable:INSTRument:ISUMmary2:PTRansition?
```

W phase (three-phase output only)

```
STATus:QUESTionable:INSTRument:ISUMmary3:PTRansition <NR1>
```

```
STATus:QUESTionable:INSTRument:ISUMmary3:PTRansition?
```

Parameter

Value: 0 to 65535 (The default value is 32767)

Response: NR1

Preset status

STAT:PRES

Resets the ENABle, PTRansition, and NTRansition filter registers of all status registers (including sub registers) to their default values.

Default values:

STATus:ENABle = 0x0000

STATus:PTRansition = 0x7FFF

STATus:NTRansition = 0x0000

Command

STATus:PRESet

SYSTEM Command

SYST:COMM:RLST

Sets the product to remote or local mode.

Command

```
SYSTem:COMMunicate:RLState <character>
```

```
SYSTem:COMMunicate:RLState?
```

Parameter

Value: LOCAL	Sets the product to local mode (Remote Disable; the RMT turns off). This enables both panel operations and commands. This is a substitute command for IEEE488.1 ren FALSE (Remote Disable).
REMOte	Sets the product to remote mode All panel keys, except the LOCAL key, are locked. This is a substitute command for IEEE 488.1 ren (Remote Enable). This is also the substitute command for address specification.
RWLock	Sets the product to remote mode All panel keys (including the LOCAL key) are locked. This is a substitute command for IEEE 488.1 llo (Local Lock Out).

Example

```
SYST:COMM:RLST REM
```

Response: Characters

SYST:CONF:ACC

Enables/disables AC coupling.

Command

```
SYSTem:CONFigure:ACCoupling[:STATe] <boolean>
```

```
SYSTem:CONFigure:ACCoupling[:STATe]?
```

Parameter

Value: ON(1) Enables AC coupling
 OFF(0) Disables AC coupling (default)

Settings are reset to default values when an *RST command is sent.

Example

```
SYST:CONF:ACC ON
```

Response: NR1

SYST:CONF:ADJ:VOLT:FINE

Sets the output voltage offset.

Use SYST:CONF:ADJ:VOLT:TERM:MODE to set whether the sensing function is enabled or disabled.

Command

```
SYSTem:CONFigure:ADJust:VOLTage:FINE <numeric>[, (@chanlist)]
```

```
SYSTem:CONFigure:ADJust:VOLTage:FINE? [ (@chanlist)]
```

Parameter

Value: -200 to +200 Voltage offset (The default value is 0)
Resolution: 10 The ones digit is rounded.

Example

```
SYST:CONF:ADJ:VOLT:FINE 10
```

Response: NR3

SYST:CONF:ADJ:VOLT:TERM:MODE

Set whether the sensing function is enabled or disabled for the voltage offset setting.
Use SYST:CONF:ADJ:VOLT:FINE to set the offset value.

Command

```
SYSTem:CONFigure:ADJst:VOLTage:TERMinal:MODE <character>  
SYSTem:CONFigure:ADJst:VOLTage:TERMinal:MODE?
```

Parameter

Value: OTERM When the sensing function is disabled (default)
 STERM When the sensing function is enabled

Example

```
SYST:CONF:ADJ:VOLT:TERM:MODE OTERM
```

Response: Characters

SYST:CONF:FORM:FRAM

Queries the number of units operating in parallel.

Command

```
SYSTem:CONFigure:FORMation:FRAMe[:COUNT]?
```

Response: NR1

Returns 1 if parallel operation is not being performed.

SYST:CONF:FORM:FRAM:INFO

Queries the information about the specified PCR-WE/ PCR-WEA.

Command

```
SYSTem:CONFIgure:FORMation:FRAMe:INFO? <NRf>
```

Parameter

Value:	0	Master unit or during standalone operation
	1	Slave 1
	2	Slave 2
	3	Slave 3

Example

```
SYST:CONF:FORM:FRAM:INFO? 0
```

Response example for model PCR3000WEA2, serial number WE3RD008, firmware version 1.00 IFC0.03.0035 IOC0.05.0079

```
KIKUSUI,PCR3000WEA2,WE3RD008,1.00 IFC0.03.0035 IOC0.05.0079
```

is returned.

SYST:CONF:FORM:PMOD

Queries the number of power modules.

One power module is 6 kW.

Command

```
SYSTem:CONFigure:FORMation:PMODule[:COUNT]?
```

Response: NR1

The PCR1000WEA/PCR2000WEA/PCR3000WEA2 returns 1.

Example: If the specified model is the PCR12000WEA, 2 is returned.

SYST:CONF:FORM:PMOD:INFO

Queries the information about the specified power module.

Command

```
SYSTem:CONFIgure:FORMation:PMODule:INFO? <Nrf_index>,<Nrf_moduleIndex>
```

Parameter <Nrf_index> The PCR-WE/PCR-WEA to be queried

Value:	0	Master unit or during standalone operation
	1	Slave 1
	2	Slave 2
	3	Slave 3

Parameter <Nrf_moduleIndex>

Value: Number of modules The module to be queried

Example

```
SYST:CONF:FORM:PMOD:INFO? 0,1
```

Response example for PCR-WEA/WEA2

```
PUC1.07.0096[1314],PFC
```

Response example for PCR-WEA2R

```
PUC1.07.0096[1314],INV INV1:V0.27 INV2:V0.27
```

SYST:CONF:FORM:PSAV:MAX

Sets the maximum expected power of the power-saving function.

Which power module is to run is automatically set.

This command is invalid for the PCR1000WEA/PCR2000WEA/PCR3000WEA2.

Command

```
SYSTem:CONFigure:FORMation:PSAVer:MAXimum <NRf>
```

```
SYSTem:CONFigure:FORMation:PSAVer:MAXimum?
```

Parameter

Value: 0 to total wattage of normally running power modules

Unit: VA

Settings are reset to default values when an *RST command is sent.

Settings are changed when the SYST:CONF:FORM:PSAV:MOD or SYST:CONF:FORM:PSAV:RES command is sent.

Example: To place a limit at 6 kW

```
SYST:CONF:FORM:PSAV:MAX 6000
```

Response: NR1

SYST:CONF:FORM:PSAV:MOD

Sets all power modules to run using the power-saving function.

This command is invalid for the PCR1000WEA/PCR2000WEA/PCR3000WEA2.

Command

```
SYSTem:CONFigure:FORMation:PSAVer:MODules <character_>[,<character>]...
```

```
SYSTem:CONFigure:FORMation:PSAVer:MODules?
```

Parameter <character>

The first parameter is the power module operating condition of the master unit.

The subsequent parameters are the power module operating conditions for slave unit 1 and later (for parallel operation only).

The number of parameters must be equal to the number of PCR-WEA units, which includes the master unit and slave units.

Parameter details: {E|D}{E|D}{E|D}{E|D}{E|D}{E|D}...

(E|D) represents power module 0, power module 1, power module 2, and so on from the left. This must be set the same as the number of slots that the PCR-WEA has.

Value:	E	Power module operated
	D	Power module not operated

The default value is EEEEEEE (standalone, all modules operated).

Example

To operate the master unit's power modules 0 and 1 and the slave unit 1's power modules 2 and 3 and set the maximum expected power to 24000 VA (6000VA×4 modules).

```
SYST:CONF:FORM:PSAV:MOD EEDDDD,DDEEDD
```

Response: Characters, [,Characters]...

SYST:CONF:FORM:PSAV:RES

Resets the maximum expected power setting of the power-saving function.

This command is invalid when the output is on (OUTP ON).

This command is invalid for the PCR1000WEA/PCR2000WEA/PCR3000WEA2.

Command

```
SYSTem:CONFigure:FORMation:PSAVer:RESet
```

Response

SYST:CONF:PHAS:UOFF

Sets the absolute phase angle of the U phase relative to the reference phase.

This command is valid for three-phase output.

If the signal source is set to external signal source (VOLT:EXT:EXTDC:SIGN:SOUR EXT), this command is invalid.

Command

```
SYSTem:CONFigure:PHASe:UOFFset <numeric>
```

```
SYSTem:CONFigure:PHASe:UOFFset?
```

Parameter

Value: -360.00 to 360.00 Absolute phase angle (The default value is 0)

Unit: DEG

Settings are reset to default values when an *RST command is sent.

Example

```
SYST:CONF:PHAS:UOFF 35.51
```

Response: NR3

SYST:CONF:PHAS:UV

Sets the U-V phase difference.

This command is valid for three-phase output or two-phase output.

If the signal source is set to external signal source (VOLT:EXT:EXTDC:SIGN:SOUR EXT), this command is invalid.

Command

```
SYSTem:CONFIgure:PHASe:UV <numeric>
```

```
SYSTem:CONFIgure:PHASe:UV?
```

Parameter

Value: -360.00 to 360.00 U-V phase difference

The default value for three-phase output is 120.

The default value for two-phase output is 180.

Unit: DEG

Settings are reset to default values when an *RST command is sent.

Example

```
SYST:CONF:PHAS:UV 121.0
```

Response: NR3

SYST:CONF:PHAS:UW

Sets the U-W phase difference.

This command is valid for three-phase output.

If the signal source is set to external signal source (VOLT:EXT:EXTDC:SIGN:SOUR EXT), this command is invalid.

Command

```
SYSTem:CONFigure:PHASe:UW <numeric>
```

```
SYSTem:CONFigure:PHASe:UW?
```

Parameter

Value: -360.00 to 360.00 U-W phase difference (The default value is 240)

Unit: DEG

Settings are reset to default values when an *RST command is sent.

Example

```
SYST:CONF:PHAS:UW 241.0
```

Response: NR3

SYST:CONF:PON:STAT

Sets the condition panel setting state when the POWER switch is turned on.

Command

```
SYSTem:CONFIgure:PON:STATe <character>
```

```
SYSTem:CONFIgure:PON:STATe?
```

Parameter

Value:	RST	Reset the panel settings
	RCL0	Settings stored in memory 0
	AUTO	The previous state before the POWER switch was turned off (this is the default value) Use OUTP:PON:STAT to set the output.

Example

```
SYST:CONF:PON:STAT RCL0
```

Response: Characters

SYST:CONF:SSUP

Enables or disables the voltage surge suppression function.

Command

```
SYSTem:CONFIgure:SSUPpression[:STATe] <boolean>
```

```
SYSTem:CONFIgure:SSUPpression[:STATe]?
```

Parameter

Value: ON(1) Enables the voltage surge function (default)
 OFF(0) Disables the voltage surge function

Example

```
SYST:CONF:SSUP ON
```

Response: NR1

SYST:CONF:TPH:MODE

Set whether to use single-phase three-wire output or two-phase output.

This command is not valid when the output is on (OUTP ON).

This command is valid in single-phase three-wire output (SYST:CONF:WIR 2).

Command

```
SYSTem:CONFigure:TPHase:MODE <boolean>
```

```
SYSTem:CONFigure:TPHase:MODE?
```

Parameter

Value: ON(1) Two-phase output
OFF(0) Single-phase three-wire output

Example

```
SYST:CONF:TPH:MODE ON
```

Response: NR1

SYST:CONF:WIR/ SYST:CONF:NOUT

Sets the output method.

This command is invalid when the output is on (OUTP ON).

This command is invalid when a sequence or a power line abnormality simulation is running.

This command is invalid on the PCR1000WEA and PCR2000WEA.

Switching between single-phase three-wire output and two-phase output is set with SYST:CONF:TPH:MODE.

Command

```
SYSTem:CONFigure:WIRing <NR1>
```

```
SYSTem:CONFigure:WIRing?
```

```
SYSTem:CONFigure:NOUtputs <NR1>
```

```
SYSTem:CONFigure:NOUtputs?
```

Parameter

Value:	1	Single-phase output
	2	Single-phase three-wire output/ Two-phase output
	3	Three-phase output

Example

```
SYST:CONF:NOUT 3
```

Response: NR1

SYST:DATE

Sets the date (UTC).

Also set the time (SYST:TIME).

The time and date are used in the timestamps of files saved to USB memory devices.

If you specify a day that does not exist (for example, February 30), the settings are changed to the first day of the following month.

Command

```
SYSTem:DATE <year_NR1>,<month_NR1>,<day_NR1>
```

```
SYSTem:DATE?
```

Parameter <year_NR1>

Value 2016 to 2037 Year

Parameter <month_NR1>

Value 1 to 12 Month

Parameter <day_NR1>

Value 1 to 31 Day

Example

```
SYST:DATE 2015,4,14
```

Response

Returns the year, month, and day in a comma-separated NR1 format.

SYST:ERR

Reads the oldest error information or event information from the error queue.

The error/event queue can hold up to 16 errors. -> [Tutorial "Error Checking"](#)(p. 352)

The error queue is cleared if a *CLS command is sent.

-> ["List of Errors"](#)(p. 322)

Command

```
SYSTem:ERRor[:NEXT]?
```

Response

Returns the oldest error or event from the error/event queue in the following format, in response to SYST:ERR?.

Example: If there is no error or event

This command returns +0 "No error."

Example: If a command that cannot be executed in the present operating state is received

This command returns -221, "Settings conflict."

SYST:ERR:COUN

Queries the number of errors occurring currently.

Command

SYSTem:ERRor:COUNT?

Response: NR1

Returns +0 if there are no errors.

SYST:EXT:DIG:READ

Queries all the signal input states of SIGNAL IN channels (CTRL.1 to CTRL.4) and SIGNAL IO channels (DIO.1, DIO.2).

Command

```
SYSTem:EXTernal:DIGital:READ?
```

Response

Returns the sum of the bit weights with high set to 1 for the signal states of the SIGNAL IN channels (CTRL.1 to CTRL.4) and SIGNAL IO channels (DIO.1, DIO.2) in NR1 format.

Ports that USERPROGIN is not mapped to is assumed to be 0 (low).

Bit	Bit weight	channel
0	1	CTRL.1
1	2	CTRL.2
2	4	CTRL.3
3	8	CTRL.4
4	16	DIO.1
5	32	DIO.2
6	64	NOT USED
7	128	NOT USED

Example: When the DIO.1 and DIO.2 signal inputs are high, 48 is returned.

SYST:EXT:DIG:WRIT

Outputs the SIGNAL OUT channels (STAT.1 to STAT.4) and SIGNAL IO channels (DIO.1, DIO.2) collectively.

Channels that USERPROGOUT is not mapped to are not output.

Command

```
SYSTem:EXTernal:DIGital:WRITe <NR1>
```

Value: 0 to 63 Sum of the bit weights with output set to 1

Bit	Bit weight	channel
0	1	STAT.1
1	2	STAT.2
2	4	STAT.3
3	8	STAT.4
4	16	DIO.1
5	32	DIO.2
6	64	NOT USED
7	128	NOT USED

Example: To output high to STAT.1 and STAT.2 and low to other channels

```
SYST:EXT:DIG:WRIT 3
```

SYST:EXT:MON:OUTP:ADJ:FMON:GAIN

Set the frequency gain of the analog monitor output.

Command

```
SYSTem:EXTernal:MONitor:OUTPut:ADJust:FMONitor:GAIN <NRf_ch>,<NRf_
gain>[, (@chanlist)]
```

```
SYSTem:EXTernal:MONitor:OUTPut:ADJust:FMONitor:GAIN? <NRf_ch>[, (@
chanlist)]
```

Parameter <NRf_ch> Channel to be configured

Value:	0	Ch.A
	1	Ch.B
	2	Ch.C

Parameter <NRf_gain>

Value: 5 to 1000

Set the denominator to range the value from 1 V/5 Hz to 1 V/1000 Hz. (The default value is 10)

Unit: HZ

Settings are reset to default values when an *RST command is sent.

Example: When setting the frequency gain of Ch.A to 1 V/10 Hz

```
SYST:EXT:MON:OUTP:ADJ:FMON:GAIN 0,10
```

Response: NR3

SYST:EXT:MON:OUTP:ADJ:FMON:OFFS

Set the frequency offset of the analog monitor output.

Command

```
SYSTem:EXTernal:MONitor:OUTPut:ADJust:FMONitor:OFFSet <NRf_ch>,<NRf_offset>[, (@chanlist)]
```

```
SYSTem:EXTernal:MONitor:OUTPut:ADJust:FMONitor:OFFSet? <NRf_ch>[, (@chanlist)]
```

Parameter <NRf_ch> Channel to be configured

Value:	0	Ch.A
	1	Ch.B
	2	Ch.C

Parameter <NRf_offset> Offset

Value: -200 to 200 (The default value is 0)

Settings are reset to default values when an *RST command is sent.

Example

```
SYST:EXT:MON:OUTP:ADJ:FMON:OFFS 0,10
```

Response: NR3

SYST:EXT:MON:OUTP:ADJ:IMON:GAIN

Set the current gain of the analog monitor output.

Command

```
SYSTem:EXTErnal:MONitor:OUTPut:ADJust:IMONitor:GAIN <NRf_ch>,<NRf_
gain>[, (@chanlist)]
```

```
SYSTem:EXTErnal:MONitor:OUTPut:ADJust:IMONitor:GAIN? <NRf_ch>[, (@
chanlist)]
```

Parameter <NRf_ch> Channel to be configured

Value: 0 Ch.A
 1 Ch.B
 2 Ch.C

Parameter <NRf_gain>

Value: 0.5 to 240

Set the denominator to range the value from 1 V/0.5 A to 1 V/240 A.

Unit: A

	Default
PCR6000WEA2	10
PCR12000WEA2	20
PCR18000WEA2	30
PCR24000WEA2	40
PCR30000WEA2	50
PCR36000WEA2	60

Settings are reset to default values when an *RST command is sent.

Example: When setting the current gain of Ch.A to 1 V/10 A

```
SYST:EXT:MON:OUTP:ADJ:IMON:GAIN 0,10
```

Response: NR3

SYST:EXT:MON:OUTP:ADJ:IMON:OFFS

Set the current offset of the analog monitor output.

Command

```
SYSTem:EXTernal:MONitor:OUTPut:ADJust:IMONitor:OFFSet <NRf_ch>,<NRf_offset>[, (@chanlist)]
```

```
SYSTem:EXTernal:MONitor:OUTPut:ADJust:IMONitor:OFFSet? <NRf_ch>[, (@chanlist)]
```

Parameter <NRf_ch> Channel to be configured

Value:	0	Ch.A
	1	Ch.B
	2	Ch.C

Parameter <NRf_offset> Offset

Value: -200 to 200 (The default value is 0)

Settings are reset to default values when an *RST command is sent.

Example

```
SYST:EXT:MON:OUTP:ADJ:IMON:OFFS 0,10
```

Response: NR3

SYST:EXT:MON:OUTP:ADJ:PMON:GAIN

Set the power gain of the analog monitor output.

Command

```
SYSTem:EXTernal:MONitor:OUTPut:ADJust:PMONitor:GAIN <NRf_ch>,<NRf_
gain>[, (@chanlist)]
```

```
SYSTem:EXTernal:MONitor:OUTPut:ADJust:PMONitor:GAIN? <NRf_ch>[, (@
chanlist)]
```

Parameter <NRf_ch> Channel to be configured

Value: 0 Ch.A
 1 Ch.B
 2 Ch.C

Parameter <NRf_gain>

Value: 33.33 to 18000

Set the denominator to range the value from 1 V/33.33 W to 1 V/18000 W.

Unit: W

	Default
PCR6000WEA2	1000
PCR12000WEA2	2000
PCR18000WEA2	3000
PCR24000WEA2	4000
PCR30000WEA2	5000
PCR36000WEA2	6000

*Settings are reset to default values when an *RST command is sent.

Example: When setting the power gain of Ch.A to 1 V/100 W

```
SYST:EXT:MON:OUTP:ADJ:PMON:GAIN 0,100
```

Response: NR3

SYST:EXT:MON:OUTP:ADJ:PMON:OFF

Set the power offset of the analog monitor output.

Command

```
SYSTem:EXTernal:MONitor:OUTPut:ADJust:PMONitor:OFFSet <NRf_ch>,<NRf_offset>[, (@chanlist)]
```

```
SYSTem:EXTernal:MONitor:OUTPut:ADJust:PMONitor:OFFSet? <NRf_ch>[, (@chanlist)]
```

Parameter <NRf_ch> Channel to be configured

Value:	0	Ch.A
	1	Ch.B
	2	Ch.C

Parameter <NRf_offset> Offset

Value: -200 to 200 (The default value is 0)

Settings are reset to default values when an *RST command is sent.

Example

```
SYST:EXT:MON:OUTP:ADJ:PMON:OFF 0,10
```

Response: NR3

SYST:EXT:MON:OUTP:ADJ:VMON:GAIN

Set the voltage gain of the analog monitor output.

Command

```
SYSTem:EXTernal:MONitor:OUTPut:ADJust:VMONitor:GAIN <NRf_ch>,<NRf_
gain>[, (@chanlist)]
```

```
SYSTem:EXTernal:MONitor:OUTPut:ADJust:VMONitor:GAIN? <NRf_ch>[, (@
chanlist)]
```

Parameter <NRf_ch> Channel to be configured

Value:	0	Ch.A
	1	Ch.B
	2	Ch.C

Parameter <NRf_gain>

Value: 1 to 100

Set the denominator to range the value from 1 V/1 V to 1 V/100 V. (The default value is 100)

Unit: V

Settings are reset to default values when an *RST command is sent.

Example: When setting the voltage gain of Ch.A to 1 V/10 V

```
SYST:EXT:MON:OUTP:ADJ:VMON:GAIN 0,10
```

Response: NR3

SYST:EXT:MON:OUTP:ADJ:VMON:OFFS

Set the voltage offset of the analog monitor output.

Command

```
SYSTem:EXTernal:MONitor:OUTPut:ADJust:VMONitor:OFFSet <NRf_ch>,<NRf_offset>[, (@chanlist)]
```

```
SYSTem:EXTernal:MONitor:OUTPut:ADJust:VMONitor:OFFSet? <NRf_ch>[, (@chanlist)]
```

Parameter <NRf_ch> Channel to be configured

Value:	0	Ch.A
	1	Ch.B
	2	Ch.C

Parameter <NRf_offset> Offset

Value: -200 to 200 (The default value is 0)

Settings are reset to default values when an *RST command is sent.

Example

```
SYST:EXT:MON:OUTP:ADJ:VMON:OFFS 0,10
```

Response: NR3

SYST:EXT:MON:OUTP:MAP

Maps Analog monitor output channels (Ch.A/ Ch.B/ Ch.C).

Command

```
SYSTem:EXTernal:MONitor:OUTPut:MAP <NRf_ch>,<character_map>[,(@chanlist)]
```

```
SYSTem:EXTernal:MONitor:OUTPut:MAP? <NRf_ch>[,(@chanlist)]
```

Parameter <NRf_ch>

```
Value:  0      Ch.A
        1      Ch.B
        2      Ch.C
```

Parameter <character_map>

<character_map>	Description
VOLT1_WAVE	Single-phase/U-phase output voltage waveform (waveform output) (Default as Ch.A)
VOLT1_RMS	Single-phase measured rms voltage/U-phase measured rms phase voltage (AC+DC) (level output)
VOLT1_DC	Single-phase average measured voltage/U-phase average measured phase voltage (DC) (level output)
LTLVOLT1_RMS	U-V phase measured rms line voltage (AC+DC) (level output)
CURR1_WAVE	Single-phase/U-phase output current waveform (waveform output) (Default as Ch.B)
CURR1_RMS	Single-phase/U-phase measured rms current (AC+DC) (level output)
CURR1_DC	Single-phase/U-phase average measured current (DC) (level output)
POW1_WAVE	Single-phase/U-phase output power waveform (waveform output) (Default as Ch.C)
POW1	Single-phase/U-phase measured active power (AC+DC) (level output)
VOLT2_WAVE	V-phase output voltage waveform (waveform output)
VOLT2_RMS	V-phase measured rms phase voltage (AC+DC) (level output)
VOLT2_DC	V-phase average measured phase voltage (DC) (level output)
LTLVOLT2_RMS	V-W phase measured rms line voltage (AC+DC) (level output)
CURR2_WAVE	V-phase output current waveform (waveform output)
CURR2_RMS	V-phase measured rms current (AC+DC) (level output)
CURR2_DC	V-phase average measured phase voltage (DC) (level output)
POW2_WAVE	V-phase output power waveform (waveform output)
POW2	V-phase measured active power (AC+DC) (level output)
VOLT3_WAVE	W-phase output voltage waveform (waveform output)
VOLT3_RMS	W-phase measured rms phase voltage (AC+DC) (level output)
VOLT3_DC	W-phase average measured phase voltage (DC) (level output)
LTLVOLT3_RMS	W-U phase measured rms line voltage (AC+DC) (level output)
CURR3_WAVE	W-phase output current waveform (waveform output)

<character_map>	Description
CURR3_RMS	W-phase measured rms current (AC+DC) (level output)
CURR3_DC	W-phase average measured current (DC) (level output)
POW3_WAVE	W-phase output power waveform (waveform output)
POW3	W-phase measured active power (AC+DC) (level output)
CURRNEUT_RMS	N-phase measured rms current (AC+DC) (level output)
CURRNEUT_DC	N-phase average measured current (DC) (level output)
TOTALPOW	Total measured active power (AC+DC) (level output)
FREQ	Internal signal source frequency (level output)

Settings are reset to default values when an *RST command is sent.

Example

```
SYST:EXT:MON:OUTP:MAP 0,VOLT_WAVE
```

Response: Characters

SYST:EXT:MON:OUTP:STAT

Enables or disables each channel of analog monitor output.

Command

```
SYSTem:EXTernal:MONitor:OUTPut:STATe <NRf_ch>,<character_state>
```

```
SYSTem:EXTernal:MONitor:OUTPut:STATe? <NRf_ch>
```

Parameter <NRf_ch> Channel to be configured

Value:	0	Ch.A
	1	Ch.B
	2	Ch.C

Parameter <character_state>

Value:	DISable	(Default)
	ENABle	

Settings are reset to default values when an *RST command is sent.

Example

```
SYST:EXT:MON:OUTP:STAT 0,ENAB
```

Response: Characters

SYST:EXT:SIGIN:MAP

Maps SIGNAL IN channels (CTRL.1 to CTRL.3).

Command

```
SYSTem:EXTernal:SIGIN:MAP <Nrf_port>,<character_map>
```

```
SYSTem:EXTernal:SIGIN:MAP? <Nrf_port>
```

Parameter <Nrf_port>

Value 1 to 3 Channel number to be mapped (CTRL.1 to CTRL.3)

Parameter <character_map>

Value:	DISabled	Disabled (default)
	OUTCTL	Output on/off
	SEQEXEC	Sequence run/stop
	ALMCLR	Alarm clear
	EXTALM	External alarm input
	WIRCTL_1P	Output method change (single-phase)
	WIRCTL_1P3W	Output method change (single-phase three-wire)
	WIRCTL_3P	Output method change (three-phase)
	VRANGE	Output range change
	RCL_A	Recall A memory
	RCL_B	Recall B memory
	RCL_C	Recall C memory
	OUTINH	Output on inhibit
	USERPROGIN	Programmable signal in

Example

```
SYST:EXT:SIGIN:MAP 1,EXTALM
```

```
SYST:EXT:SIGIN:MAP? 1
```

Response: Characters

SYST:EXT:SIGIN:POL

Sets the polarity of the parameter to map to SIGNAL IN.

This command is invalid when the output is on (OUTP ON).

Command

```
SYSTem:EXTernal:SIGIN:POLarity <Nrf_port>,<character_pol>
```

```
SYSTem:EXTernal:SIGIN:POLarity? <Nrf_port>
```

Parameter <Nrf_port>

Value 1 to 4 Channel number to be mapped (CTRL.1 to CTRL.4)

Parameter <character_pol>

Value: POSitive Positive edge (default)

NEGative Negative edge

Example

```
SYST:EXT:SIGIN:POL 1,NEG
```

Response: Characters

SYST:EXT:SIGIN:STAT

Queries the signal level of the SIGNAL IN channel.

Command

```
SYSTem:EXTernal:SIGIN:STATe? <NRf>
```

Response

Value 1 to 4 Channel number to be queried (CTRL.1 to CTRL.4)

Example

```
SYST:EXT:SIGIN:STAT? 1
```

Response

Returns 1 when the signal level is high and 0 when it is low.

Returns 0 if USERPROGIN is not mapped to the SIGNAL IN channel.

SYST:EXT:SIGOUT:MAP

Maps SIGNAL OUT channels (STAT.1 to STAT.3).

Command

```
SYSTem:EXTernal:SIGOUT:MAP <Nrf_port>,<character_map>
```

```
SYSTem:EXTernal:SIGOUT:MAP? <Nrf_port>
```

Parameter <Nrf_port>

Value 1 to 3 Channel number to be mapped (STAT.1 to STAT.3)

Parameter <character_map>

Value:	DISabled	Disabled (default)
	OUTON	Output on status
	IPKLIM	Current peak limit status
	OVERLOAD	Overload status
	BUSY	Busy status
	WIRING_1P	Output method status (single-phase)
	WIRING_1P3W	Output method status (single-phase three-wire)
	WIRING_3P	Output method status (three-phase)
	VRANGE-H	Output voltage H range status
	POWON	POWER switch on status
	SEQSTAT	Sequence/power line abnormality simulation status
	USERPROGOUT	Programmable signal status

Example

```
SYST:EXT:SIGOUT:MAP 1,BUSY
```

Response: Characters

SYST:EXT:SIGOUT:POL

Sets the polarity of the parameter to map to SIGNAL OUT.

This command is invalid when the output is on (OUTP ON).

Command

```
SYSTem:EXTernal:SIGOUT:POLarity <Nrf_port>,<character_pol>
```

```
SYSTem:EXTernal:SIGOUT:POLarity? <Nrf_port>
```

Parameter <Nrf_port>

Value 1 to 4 Channel number to be mapped (STAT.1 to STAT.4)

Parameter <character_pol>

Value: HIGH (Default)
LOW

Example

```
SYST:EXT:SIGOUT:POL 1,LOW
```

Response: Characters

SYST:EXT:SIGOUT:STAT

Sets the signal level of the SIGNAL OUT channel.

This command is valid only when USERPROGOUT is mapped to the SIGNAL OUT channel.

Command

```
SYSTem:EXTeRnal:SIGOUT:STATe <Nrf_port>,<boolean_pol>
```

Parameter <Nrf_port>

Value 1 to 3 Channel number to be mapped (STAT.1 to STAT.3)

Parameter <boolean_pol>

Value: ON(1) HIGH (Default)
OFF(0) LOW

An error occurs if USERPROGOUT is not mapped to the SIGNAL OUT channel.

Example

```
SYST:EXT:SIGOUT:STAT 1,ON
```

SYST:EXT:SSIGIO:MAP

Maps SIGNAL IO channels (DIO.1, DIO.2).

Command

```
SYSTem:EXTernal:SSIGIO:MAP <NRf_port>,<character_inout>,<character_map>
```

```
SYSTem:EXTernal:SSIGIO:MAP? <NRf_port>
```

Parameter <NRf_port>

Value 1 to 2 Channel number to be mapped (DIO.1, DIO.2)

Parameter <character_inout>

Value: IN Control using external contacts
OUT Monitors the operation status
DISable Disabled (default)

Parameter <character_map> (<character_inout> is set to IN)

Value: SYNCCLK Output reference phase signal
SEQTRIGIN Sequence trigger input
OUTCTL Output on/off
SEQEXEC Sequence run/stop
ALMCLR Alarm clear
EXTALM External alarm input
WIRCTL_1P Output method change (single-phase)
WIRCTL_1P3W Output method change (single-phase three-wire)
WIRCTL_3P Output method change (three-phase)
VRANGE Output range change
RCL_A Recall A memory
RCL_B Recall B memory
RCL_C Recall C memory
OUTINH Output on inhibit
USERPROGIN Programmable signal in

Parameter <character_map> (When <character_inout> is set to OUT)

Value: STDCLK Output reference phase output
SEQTRIGOUT Sequence trigger output
OUTON Output on status
IPKLIM Current peak limit status
OVERLOAD Overload status
BUSY Busy status

WIRING_1P	Output method status (single-phase)
WIRING_1P3W	Output method status (single-phase three-wire)
WIRING_3P	Output method status (three-phase)
VRANGEH	Output voltage H range status
POWON	POWER switch on status
SEQSTAT	Sequence/power line abnormality simulation status
USERPROGOUT	Programmable signal status

Example

```
SYST:EXT:SSIGIO:MAP 1,IN,VRANGE
```

Response

Returns the I/O of the specified channel and the mapped parameters in order in comma-separated character format.

SYST:EXT:SSIGIO:POL

Sets the polarity of the parameter to map to SIGNAL IO.

This command is invalid when the output is on (OUTP ON).

Command

```
SYSTem:EXTernal:SSIGIO:POLarity <NRf_port>,<character_pol>
```

```
SYSTem:EXTernal:SSIGIO:POLarity? <NRf_port>
```

Parameter <NRf_port>

Value 1 to 2 Channel number to be mapped (DIO.1, DIO.2)

Parameter <character_pol> (When <character_map> is set to input parameters)

Value: POSitive Positive edge (default)
NEGative Negative edge

Parameter <character_pol>

Value: HIGH (Default)
LOW

Example

```
SYST:EXT:SSIGIO:POL 1,LOW
```

Response: Characters

SYST:EXT:SSIGIO:STAT

Sets the signal level of the SIGNAL IO channel.

The set command is valid only when USERPROGOUT is mapped to the SIGNAL IO channel.

The query command is valid only when USERPROGIN is mapped to the SIGNAL IO channel.

Command

```
SYSTem:EXTernal:SSIGIO:STATe <Nrf_port>,<boolean_pol>
```

```
SYSTem:EXTernal:SSIGIO:STATe? <Nrf_port>
```

Parameter <Nrf_port>

Value 1 to 2 Channel number to be mapped (DIO.1, DIO.2)

Parameter <boolean_pol>

Value: ON(1) HIGH (Default)
OFF(0) LOW

An error occurs if USERPROGOUT is not mapped to the SIGNAL IO channel.

Example

```
SYST:EXT:SSIGIO:STAT 1,ON
```

```
SYST:EXT:SSIGIO:STAT? 1
```

Response

Returns 1 when the signal level is high and 0 when it is low.

Returns 0 if USERPROGIN is not mapped to the SIGNAL IO channel.

SYST:KLOC

Sets or releases panel control lock.

Command

```
SYSTem:KLOCK <boolean>
```

```
SYSTem:KLOCK?
```

Parameter

Value: ON(1) Locks the panel control
OFF(0) Unlocks the panel control

Response: NR1

SYST:LOC/ SYST:REM/ SYST:RWL

This is an old style command.

Use SYST:COMM:RLST(p. 248) when creating new programs.

Command

SYSTem:LOCal

SYSTem:REMOte

SYSTem:RWLock

SYST:OPT

Queries the optional interface boards that are installed in the product.

This is an alias for *OPT.

Command

```
SYSTem:OPTion?
```

Response

Returns the installed options in comma-separated string format. Returns "0" if no options are installed.

SYST:PASS

Enables a password-protected command.

Command

```
SYSTem:PASSword[:CENable] "<string>"
```

```
SYSTem:PASSword[:CENable]?
```

Parameter

Value: Enter password set by SYSTem:PASSword:NEW

Response: "string"

Example

```
SYST:PASS "password"
```

SYST:PASS:CDIS

Disable the password-protected command.

Command

```
SYSTem:PASSword:CDISable "<string>"
```

Parameter

Value: Enter password set by SYSTem:PASSword:NEW

Example

```
SYST:PASS:CDIS "password"
```

SYST:PASS:NEW

Set the password.

Command

```
SYSTem:PASSword:NEW "<string_exist>","<string_new>"
```

Parameter "<string_exist>": existing password, "<string_new>" new password

Characters that can be used: alphanumeric characters (A-Z, a-z, 0-9), underscore,
hyphen

Number of characters: 4 to 15

The default value is "".

Example

```
SYST:PASS:NEW "existing password", "new password"
```

SYST:PASS:STAT

Queries whether a password-protected command is valid or invalid.

Command

```
SYSTem:PASSword[:CENable]:STATe?
```

Response: NR1

Example

```
SYST:PASS:STAT?
```

SYST:SEC:IMM

Sanitizes the product to its factory default settings.

Communication settings are also returned to their factory default conditions.

This is valid when the password protection command is valid (SYST:PASS).

When parallel operation in use, set the rotary switches for the address and the number of slave units on the master unit and all slave units to zero, and then use this command.

— Note —

Sanitization clears all user-defined state information and user-defined I/O settings such as the IP address. Because unexpected data loss may occur, sanitization is recommended only after firmware updates.

Command

```
SYSTem:SECurity:IMMediate
```

SYST:SLE

Turns the sleep function on and off.

Even if the sleep function is turned off, you can activate the sleep function by sending the SYST:SLE:EXEC command.

Use SYST:SLE:TIME to set the time that must elapse before the PCR-WEA enters sleep mode.

Command

```
SYSTem:SLEep[:STATe] <boolean>
```

```
SYSTem:SLEep[:STATe]?
```

Parameters

Parameter

Value: ON(1) The sleep function turns on.
OFF(0) The sleep function is turned off (default).

Settings are reset to default values when an *RST command is sent.

Response: NR1

SYST:SLE:EXEC

Activates sleep mode immediately.

This command is valid even when the sleep function has been turned off (SYST:SLE OFF).

This command is not valid when the output is on (OUTP ON), when an alarm has occurred, when a sequence is being executed, and when the PCR-WEA is in the WTG state.

Command

```
SYSTem:SLEep:EXECute
```

SYST:SLE:TIME

Sets the time that must elapse before the product enters sleep mode.

Use SYST:SLE to turn the sleep function on and off.

Command

```
SYSTem:SLEep:TIME <numeric>
```

```
SYSTem:SLEep:TIME?
```

Parameter

Value: 60 to 3600 (The default value is 3600)

Unit: S

Settings are reset to default values when an *RST command is sent.

Response: NR3

SYST:TIME

Sets the time.

Also set the date (using SYST:CONF:DATE).

The time and date are used in the timestamps of files saved to USB memory devices.

Command

```
SYSTem:TIME <hour_NR1>,<min_NR1>,<sec_NR1>
```

```
SYSTem:TIME?
```

Parameter <hour_NR1>

Value 0 to 23 Hour

Parameter <min_NR1>

Value 0 to 59 Minutes

Parameter <sec_NR1>

Value 0 to 59 second

Example

```
SYST:TIME 23,0,0
```

Response

Returns the hour, minute, and second in NR1 format.

SYST:TIME:ADJ

Automatically synchronizes the system clock using the NTP server on the network.

Command

```
SYSTem:TIME:ADJust
```

SYST:TZON

Sets the time zone of the system clock.

Use SYST:TZON:CAT? to check the time zone ID.

Command

```
SYSTem:TZONE "<string>"
```

```
SYSTem:TZONE?
```

Parameter

Value: Time zone ID or UTC (The default value is "UTC")

Example

```
SYST:TZON "Asia/Tokyo"
```

Response: "string"

SYST:TZON:CAT

Queries the time zone IDs that can be used.

Command

```
SYSTem:TZONe:CATalog?
```

Response: Comma-separated character string

SYST:VERS

Queries the version of the SCPI specifications that the product complies with.

Command

```
SYSTem:VERSion?
```

Response

Returns 1999.0.

TRIGger Command

TRIG:ACQ

Executes a software trigger on the ACQUIRE trigger subsystem.

Command

```
TRIGger:ACQuire[:IMMediate]
```

TRIG:ACQ:SOUR

Sets the condition (trigger source) for actually starting the measurement after the AC-Quire trigger subsystem receives an INIT:ACQ.

Command

```
TRIGger:ACQuire:SOURce <character>
```

```
TRIGger:ACQuire:SOURce?
```

Parameter

Value:	IMMediate	Starts the measurement immediately (default)
	BUS	Waits for a software trigger (a *TRG, TRIG:ACQ, or IEEE 488.1 get—Group Execute Trigger—command), and then begin measuring

Settings are reset to default values when an *RST command is sent.

Example

```
TRIG:ACQ:SOUR BUS
```

Response: Characters

TRIG:PROG

Executes a software trigger on the PROGram trigger subsystem.

Command

```
TRIGger:PROGram[:IMMediate]
```

TRIG:PROG:SOUR

Sets the condition (trigger source) for actually starting the sequence operation after the PROGRAM trigger subsystem receives an INIT:PROG.

Command

```
TRIGger:PROGram:SOURce <character>
```

```
TRIGger:PROGram:SOURce?
```

Parameter

Value:	IMMediate	Execute the sequence immediately (default)
	BUS	Waits for a software trigger (a *TRG, TRIG:PROG, or IEEE 488.1 get—Group Execute Trigger—command), and then execute the sequence

Settings are reset to default values when an *RST command is sent.

Example

```
TRIG:PROG:SOUR BUS
```

Response: Characters

TRIG:SIM

Executes a software trigger on the SIMulation trigger subsystem.

Command

```
TRIGger:SIMulation[:IMMediate]
```

TRIG:SIM:SOUR

Sets the condition (trigger source) for actually executing the simulation after the SIMulation trigger subsystem receives an INIT:SIM.

Command

```
TRIGger:SIMulation:SOURce <character>
```

```
TRIGger:SIMulation:SOURce?
```

Parameter

Value:	IMMEDIATE	Executes the power line abnormality simulation immediately (default)
	BUS	Waits for a software trigger (a *TRG, TRIG:TRAN, or IEEE 488.1 get—Group Execute Trigger—command), and then execute the power line abnormality simulation

Settings are reset to default values when an *RST command is sent.

Example

```
TRIG:SIM:SOUR BUS
```

Response: Characters

TRIG:TRAN

Executes a software trigger on the TRANsient trigger subsystem.

Command

```
TRIGger:TRANsient[:IMMediate]
```

TRIG:TRAN:SOUR

Sets the condition (trigger source) for actually changing the settings after the TRANSient trigger subsystem receives an INIT:TRAN.

Command

```
TRIGger:TRANSient:SOURce <character>
```

```
TRIGger:TRANSient:SOURce?
```

Parameter

Value:	IMMEDIATE	Change the settings immediately (default)
	BUS	Change the settings when a software trigger (*TRG, TRIG:TRAN, IEEE488.1 get (Group Execute Trigger) is received

Settings are reset to default values when an *RST command is sent.

Example

```
TRIG:TRAN:SOUR BUS
```

Response: Characters

WAVE Command

WAVE:DATA:ARB

Sets a user-defined waveform with block data at the waveform bank that you specify by its number.

If you overwrite the content of the bank selected with FUNC:BANK, the change is immediately applied.

This command is not valid when the synchronization function is in use (FREQ:SYNC ON).

Command

```
WAVE:DATA:ARbitrary <NRf>,<block>
```

```
WAVE:DATA:ARbitrary
```

Parameter <NRf>

Value: 1 to 256 Waveform bank number

Parameter <block>

Value: User-defined waveform

Fixed to Big Endian. Size fixed to 4096 words (8192 octets)

16-bit integer array, each value ranging from -32768 to +32767

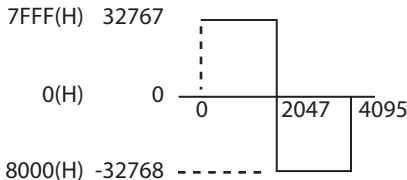

Example

```
WAVE:DATA:ARB 5,#481927FFF7FFF...7FFF...80008000
```

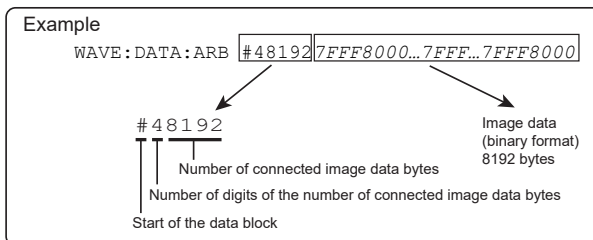

Response: block

WAVE:DATA:CLIP

Sets the crest factor of the peak clipped waveform at the waveform bank that you specify by its number.

This command is not valid when the synchronization function is in use (FREQ:SYNC ON).

Command

```
WAVE:DATA:CLIP <BANK_NRf>,<PCLIP_numeric>
```

```
WAVE:DATA:CLIP? <BANK_NRf>
```

Parameter <BANK_NRf>

Value: 1 to 256 Waveform bank number

Parameter <PCLIP_numeric>

Value: 1.10 to 1.40 Crest factor of the peak clipped waveform (The default value is 1.40)

Example

```
WAVE:DATA:CLIP 5,1.20
```

Response: NR3 format

WAVE:DATA:IECP

Sets the clip factor of the flat curve waveform at the waveform bank that you specify by its number.

This command is not valid when the synchronization function is in use (FREQ:SYNC ON).

Command

```
WAVE:DATA:IECPclip <BANK_NRf>,<PCLIP_numeric>
```

```
WAVE:DATA:IECPclip? <BANK_NRf>
```

Parameter <BANK_NRf>

Value: 1 to 256 Waveform bank number

Parameter <PCLIP_numeric>

Value: 0.4 to 1.0 Clip factor of the flat curve waveform (The default value is 1.0)

Example

```
WAVE:DATA:IECP 5,0.8
```

Response: NR3

WAVE:DATA:POIN

Sets a user-defined waveform by specifying the waveform bank number and the point.

Command

```
WAVE:DATA:POINT <BANK_NRf>,<POINT_NRf>,<DATA_NRf>
```

```
WAVE:DATA:POINT? <BANK_NRf>,<POINT_NRf>
```

Parameter <BANK_NRf>

Value: 1 to 256 Waveform bank number

Parameter <POINT_NRf>

Value: 0 to 4095 point

Parameter <DATA_NRf>

Value: -32768 to +32767

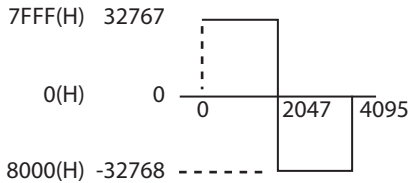
**Example**

To set point 1023 of waveform bank number 2 to 32767

```
WAVE:DATA:POINT 2,1023,32767
```

Response: NR3

WAVE:DATA:SIN

Sets the waveform bank that you specify by its number to sine wave.

This command is not valid when the synchronization function (FREQ:SYNC ON) is on.

Command

```
WAVE:DATA:SINusoid <NR1>
```

Parameter

Value: 1 to 256 that you want to execute

Example

```
WAVE:DATA:SIN 5
```

WAVE:DATA:TYPE

Queries the waveform type at the waveform bank that you specify by its number.

Command

```
WAVE:DATA:TYPE? <NR1>
```

Response: character

Parameter <NRf>

Value: 1 to 256 Waveform bank number

Response value

Value:	SINusoid	Sine
	CLIP	Peak-clipped waveform
	IECPclip	Flat curve waveform
	ARBitrary	User-defined waveform

List of Errors

Command errors

An error in the range [-199, -100] indicates that an IEEE 488.2 syntax error has been detected by the instrument's parser. The occurrence of any error in this class causes the Command Error bit (bit 5) in the event status register to be set.

Error code	Error message description
-100	Command error Command error. Generic syntax error.
-101	Invalid character An invalid character exists. A data element different than those allowed was recognized.
-102	Syntax error Syntax error. An unrecognized command or data type was encountered.
-103	Invalid separator Invalid separator The parser was expecting a separator and encountered an illegal character.
-104	Data type error Data type error. The parser recognized a data element different than one allowed.
-105	GET not allowed Get not allowed. A Group Execute Trigger was received in a program message.
-108	Parameter not allowed Parameter not allowed More parameters were received than expected for the header.
-109	Missing parameter Missing parameter Fewer parameters were received than required for the header.
-110	Command header error Command header error. An error was detected in the header.
-112	Program mnemonic too long Mnemonic too long. The number of characters in the command header exceeds 12 characters.
-113	Undefined header Undefined header. Inappropriate for the product.
-114	Header suffix out of range Invalid suffix exists in the header.
-115	Unexpected number of parameters Unexpected parameters were received in the header.
-120	Numeric data error Numeric data error. Generated when parsing a data element which appears to be numeric, including the nondecimal numeric types.
-128	Numeric data not allowed Numeric data is not allowed.
-130	Suffix error Suffix error. Generated when parsing a suffix.
-131	Invalid suffix A suffix is invalid. The suffix does not follow the syntax, or the suffix is inappropriate for the product.
-134	Suffix too long Suffix too long. The suffix contains too many characters.
-138	Suffix not allowed A suffix was encountered after a numeric parameter that does not allow suffixes.
-140	Character data error Character data error. Generated when parsing a character data element.

Error code	Error message description
-141	Invalid character data Either the character data element contains an invalid character, or the element is not valid.
-144	Character data too Long Character data too long. The character data element contains too many characters.
-148	Character data not allowed Character data is not allowed.
-150	String data error String data error. Generated when parsing a string data element.
-151	Invalid string data Invalid string data.
-158	String data not allowed String data is not allowed.
-160	Block data error Block data error. Generated when parsing a block data element.
-170	Expression error Expression error. Generated when parsing an expression data element.
-180	Macro error Generated when defining a macro or executing a macro.

Execution errors

An error in the range [-299, -200] indicates that an error has been detected by the instrument's execution control block. The occurrence of any error in this class causes the Execution Error bit (bit 4) in the event status register to be set.

Error code	Error message description
-200	Execution error (generic) Execution error. A generic product error.
-203	Command protected Password protected program or query command cannot be executed.
-210	Trigger error Trigger error.
-211	Trigger ignored A trigger was received but ignored.
-213	Init ignored A measurement initiate operation was ignored because measurement is in progress.
-214	Trigger deadlock A deadlock occurred because a query was received before the software trigger.
-220	Parameter error Invalid parameter.
-221	Settings conflict A command was received that the product cannot execute in its present condition.
-222	Data out of range Parameter was out of range.
-223	Too much data Too many parameters were received for the requirements.
-224	Illegal parameter value Received invalid parameter data.
-230	Data corrupt or stale Received a data query before the measurement completed.
-241	Hardware missing Cannot be executed because the optional hardware is not installed.

Product-specific errors

The occurrence of any error in this class causes the Device Dependent Error bit (bit 3) in the event status register to be set.

Error code	Error message description
-310	System error
-311	Memory error
-313	Calibration memory lost
-314	Save/recall memory lost
-315	Configuration memory lost
-330	Self-test failed
-350	Queue overflow
-360	Communication error
-362	Framing error in program message
-363	Input buffer overrun
-365	Time out error

Query errors

An error in the range [-499, -400] indicates that the output queue control of the instrument has detected a problem with the message exchange protocol described in IEEE 488.2, chapter 6. The occurrence of any error in this class causes the Query Error bit (bit 2) in the event status register to be set.

Error code	Error message description
-400	Query error (generic)
-410	Query INTERRUPTED
-420	Query UNTERMINATED
-430	Query DEADLOCKED
-440	Query UNTERMINATED after indefinite response

Operation complete event errors

An error in the range [-899, -800] is used when the product wants to report an IEEE 488.2 operation complete event. This event occurs when the instrument's synchronization protocol, having been enabled by an *OPC command, completes all selected pending operations.

The occurrence of any error in this class causes the Operation Complete bit (bit 0) in the event status register to be set.

Error code	Error message description
-800	Operation complete All selected pending operations in accordance with the IEEE 488.2, 12.5.2 synchronization protocol have completed.

Product-dependent errors

The occurrence of any error in this class causes the Device Dependent Error bit (bit 3) in the event status register to be set.

■ Configuration change rejection errors

These errors occur when the specified configuration changes cannot be permitted.

Error code	Error message
+100	Setting change denied while OUTPut ON state
+101	Setting change denied while TRANsient trigger in progress
+102	Setting change denied while SIMulation trigger in progress
+103	Setting change denied while PROGram trigger in progress
+104	Setting change denied while frequency synchronous.
+105	Setting change denied while BUSY
+106	Setting change denied while SIMulation in progress
+107	Setting change denied while PROGram in progress
+108	Setting change denied while SLEep mode
+109	Setting change denied while EXT PROGram SOURce selected
+110	Setting change denied while INT+EXT PROGram SOURce selected
+111	Setting change denied while V PROGram SOURce selected
+112	Setting change denied while SStart in progress
+113	Setting change denied while SStop in progress

■ Configuration conflict errors

These errors occur settings are in conflict with the existing settings.

Error code	Error message
+201	Conflicts with OUTPut OFF state

Error code	Error message
+202	Conflicts with PROTection state
+203	Conflicts with WIRing configuration
+204	Conflicts with BUSY state
+205	Conflicts with CURRent PROTection LIMit selected
+206	Conflicts with CURRent PROTection TRIP selected
+207	Conflicts with SStart function enabled
+208	Conflicts with Remote Inhibit operation
+209	Conflicts with EXTeRnal PROGRam SOURce selected
+210	Conflicts with INTeRnal PROGRam SOURce selected
+211	Conflicts with unbalanced PHASe configuration
+212	Conflicts with unbalanced VOLTage configuration
+213	Conflicts with TRANsient trigger in progress
+214	Conflicts with SIMulation trigger in progress
+215	Conflicts with PROGRam trigger in progress
+216	Conflicts with external digital input
+217	Conflicts with OUTPut IMPedance REAL
+218	Conflicts with OUTPut IMPedance REACTIVE
+219	Conflicts with SStop function enabled
+220	Conflicts with V PROGRam SOURce selected
+225	Conflicts with Out of RANGe(VOLT)
+226	Conflicts with Out of RANGe(FREQ)
+227	Conflicts with Out of RANGe(IMP)
+228	Conflicts with Out of RANGe(TIME)
+230	Conflicts with existing AC VOLTage (IMMediate)
+231	Conflicts with existing AC VOLTage (TRIGgered)
+232	Conflicts with existing DC VOLTage (IMMediate)
+233	Conflicts with existing DC VOLTage (TRIGgered)
+234	Conflicts with existing AC+DC overlaid VOLTage (IMMediate)
+235	Conflicts with existing AC+DC overlaid VOLTage (TRIGgered)
+236	Overlapping too much AC+DC voltage
+237	Conflicts with non-zero DC VOLTage
+238	Conflicts with high-ranged T3 VOLTage
+239	Conflicts with existing FREQuency (IMMediate)
+240	Conflicts with existing FREQuency (IMMediate)
+241	Conflicts with soft VOLTage LIMit settings
+242	Conflicts with soft VOLTage OFFSet LIMit settings
+243	Conflicts with soft FREQuency LIMit settings
+244	Conflicts with TRIP in DISabled state
+245	Conflicts with non-zero AC VOLTage
+250	Conflicts with VOLTage COMPensate not in DISabled state
+251	Conflicts with HARD voltage compensation
+252	Conflicts with SOFT voltage compensation
+253	Conflicts with REG-ADJ voltage compensation
+254	Conflicts with CV RESPonse MEDium or FAST
+255	Conflicts with FREQuency SYNChronize function enabled
+256	Conflicts with OUTPut IMPedance function enabled
+257	Conflicts with non-zero waveform BANK active

Error code	Error message
+258	Conflicts with PHASe ON
+259	Conflicts with PHASe OFF
+260	Conflicts with PHAS.CHG in PROGRAM

■ Operation errors

These errors occur when invalid or incorrect settings are specified.

Error code	Error message
+300	Invalid phase number
+301	Invalid WAVE BANK name
+302	Name already used by other BANK
+303	Block data is too long
+304	Block data is too short
+306	Channel list is forbidden
+311	Illegal PROGRAM name
+312	PROGRAM name already exists
+313	PROGRAM not found
+314	PROGRAM not selected
+315	PROGRAM not running
+316	Cannot delete selected PROGRAM
+317	Invalid STEP index
+318	Power saver unsupported

■ Security errors

Error code	Error message
+501	Wrong password
+502	Illegal password format

■ Errors related to the self-test function

These errors occur as results of self-tests executed with *TST? queries.

Error code	Error message
+901	Detected empty power module slot
+902	Detected malfunctioning power module
+903	Invalid master/slave configuration

■ EIOC errors

The +1000 error is an internal error of the product.

Command processing time

A certain amount of time is required before the commands shown in the following table are received by the product.

The processing times shown here are standard values, not guaranteed values.

The processing times vary depending on the settings and the measurement conditions.

The values shown below do not include hardware response times.

Command	GPIB* ¹ processing time (ms)	USB processing time (ms)	RS232C* ² processing time (ms)	LAN* ³ processing time (ms)	Description
VOLT	7	7	5	6	Sets the voltage
MEAS:VOLT?	111	110	100	120	Queries the measured output voltage
FREQ	6	6	6	6	Sets the frequen- cy
MEAS:CURR?	111	110	100	120	Queries the measured output current
*RST	600	500	500	520	Resets the device

*¹: Using a USB-GPIB by National Instruments

*²: Baud rate setting: 19200bps

*³: 100BASE-TX Ethernet

Tutorial

Programming AC Output

■ Setting the AC voltage and frequency

The AC voltage and frequency are controlled by the `VOLTage` and `FREQUENCY` commands. First, set the voltage range.

```
VOLTage:RANGe 161 'Sets the voltage range to L
VOLTage 110 'Sets the AC voltage to 110 V
FREQUENCY 55 'Sets the frequency to 55 Hz
OUTPut ON 'Turns the output on
```

■ Setting the AC voltage and frequency limits

The maximum AC voltage value varies depending on the voltage range setting.

Further, the maximum and minimum AC voltage and frequency values may vary depending on the limit settings. The AC voltage and frequency must be set within the range defined by the specified limits.

The voltage and frequency limits are safety interlock functions to avoid operation errors and programming errors. They are not output limit functions.

```
VOLTage:RANGe 161 'Sets the voltage range to L
VOLTage:LIMit:UPPer MAX 'Sets the upper voltage limit to the maximum
VOLTage:LIMit:LOWer MIN 'Sets the lower voltage limit to the minimum
VOLTage 110 'Sets the AC voltage to 110 V
FREQUENCY:LIMit:UPPer MAX 'Sets the upper frequency limit to the maximum
FREQUENCY:LIMit:LOWer MIN 'Sets the lower frequency limit to the minimum.
FREQUENCY 55 'Sets the frequency to 55 Hz
```

In the above example, the limits are set to the maximum so that any AC voltage and frequency within the range can be specified.

If the voltage range is set to L, the AC voltage cannot be set greater than 161 V.

■ Query

To query the maximum or minimum value of the AC voltage and frequency, include the `MINimum` or `MAXimum` parameter in the query.

VOLTage? MINimum
VOLTage? MAXimum
FREQuency? MINimum
FREQuency? MAXimum

Programming DC Output

■ Setting the DC voltage

The output voltage is controlled with the `VOLTage:OFFSet` command. First, set the voltage range.

`VOLTage:RANGe 161` 'Sets the voltage range to L

`VOLTage:OFFSet 40` 'Sets the DC voltage to 40 V

`OUTPut ON` 'Turns the output on

The voltage range cannot be changed when the output is on. The DC voltage can be changed when the output is on.

■ Setting the DC voltage limits

The maximum DC voltage value varies depending on the voltage range setting. Further, the maximum and minimum DC voltage values may vary depending on the limit settings.

`VOLTage:RANGe 161` 'Sets the voltage range to L

`VOLTage:OFFSet:LIMit:UPPer MAX` 'Sets the upper voltage limit to the maximum

`VOLTage:OFFSet:LIMit:LOWer MIN` 'Sets the lower voltage limit to the minimum

`VOLTage:OFFSet 40` 'Sets the DC voltage to 40 V

In the above example, the limits are set to the maximum so that any DC voltage within the range can be specified.

For the DC voltage, specify the voltage range using an AC voltage expression. The DC voltage setting range is ± 227.5 V for the L range and ± 455.0 V for the H range.

■ Query

To query the maximum or minimum value, include the `MINimum` or `MAXimum` parameter in the query as shown below.

`VOLTage:OFFSet? MINimum`

`VOLTage:OFFSet? MAXimum`

Trigger Subsystem

This product has four different trigger subsystems.

- TRANsient

This subsystem is used to change the voltage and frequency settings.

- ACQuire

This subsystem is used to measure voltage, current, and power.

- SIMulation

This subsystem executes power line abnormality simulations.

- PROGram

This subsystem executes sequences.

This command cannot be executed simultaneously with the TRANsient, SIMulation, or PROGram subsystem.

The TRANSient, ACQuire, SIMulation, and PROGram trigger subsystems have three states (IDLE state, INITiated state, WTG state).

- IDLE state

When the product is turned on, all trigger subsystems are in the IDLE state. In this state, the trigger subsystem ignores all triggers. If you send any of the following commands, the trigger subsystem is switched to the IDLE state, regardless of its current state.

ABORt

*RST

*RCL

IEEE488.1 sdc (Selected Device Clear) or dcl (Device Clear)

- INITiated state

When you send the INIT command while the product is in the IDLE state, the trigger function begins operating, and the product switches to the INITiated state.

If the trigger source is set to IMMEDIATE, the settings are changed immediately, or the measurement, power line abnormality simulation, or sequence starts immediately.

If the trigger source is set to BUS, the product switches to the WTG (Waiting for Trigger) state.

- WTG (Waiting for Trigger) state

If a trigger is received in the WTG state, the settings are changed, or the measurement, power line abnormality simulation, or sequence starts.

Changing the output with triggers (TRANSient)

The TRANSient group is a trigger subsystem for changing settings. This subsystem is used to change the voltage and frequency settings.

■ Output change control

You can use the TRIGger:TRANSient subsystem to synchronize the changes in the output with triggers. This is useful when you want to synchronize the changes in the output to the operation of external devices, such as DC power supplies and electronic loads.

Use the VOLTage:TRIGgered and FREQuency:TRIGgered command to reserve trigger settings.

VOLTage 110 'Sets the voltage to 110 V

FREQuency 60 'Sets the frequency to 60 Hz

VOLTage:TRIGgered 100 'Sets the voltage that will be set when a trigger is received to 100 V

FREQuency:TRIGgered 50 'Sets the frequency that will be set when a trigger is received to 50 Hz

TRIGger:TRANSient:SOURce BUS 'Sets the trigger source to BUS

INITiate:TRANSient 'Initiates the TRANSient group (starts the trigger function)

TRIGger:TRANSient 'Applies a software trigger to the TRANSient group

If you repeatedly change the output, a trigger error (-210) may occur.* By using the *OPC command, you can prevent this error.-> [“Waiting for Operation Complete”](#)(p. 348)

TRIGger:TRANSient;*OPC 'Applies a trigger and waits until the output change is complete

States

Trigger operation has three states: IDLE, INITiated, and WTG.

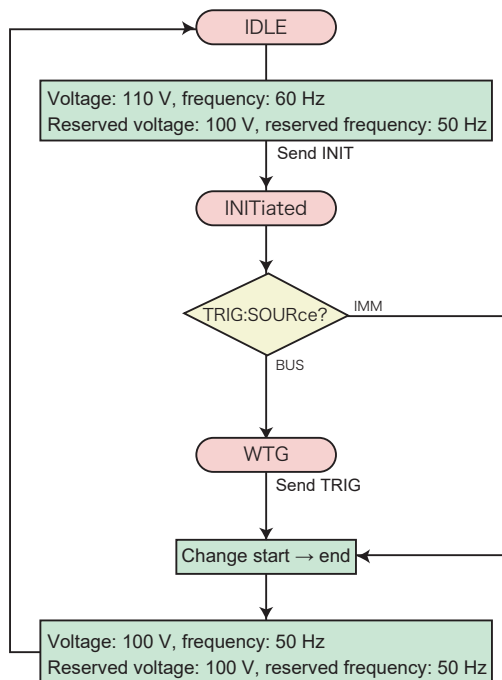

Use the TRIGGER:TRANSIENT:SOURCE command to set the trigger source to BUS or IMMEDIATE.

If the trigger source is set to IMMEDIATE, an INITIATE command immediately executes changes and sets the voltage and frequency to their new values. If the trigger source is set to BUS, the trigger subsystem enters the WTG (Waiting For Trigger) state. When a software trigger is received (through the TRIGGER:TRANSIENT:IMMEDIATE command or *TRG command), the changes begin.

When the operation is complete, the trigger subsystem returns to the IDLE state again. If the ABORT command or an equivalent command is received instead of a trigger, the changes are canceled, and the trigger subsystem returns to the IDLE state.

The programmable parameters of the TRANSIENT group are AC voltage, DC voltage, and frequency. The current limit setting cannot be changed using triggers.

TRIGGER:TRANSIENT:IMMEDIATE only applies a software trigger to the TRANSIENT group.

You can also use the *TRG command or the IEEE488.1 get (Group Execute Trigger)

command for the same purpose. This command applies a software trigger to all trigger subsystems, if there are other trigger subsystems in the initiated state, their trigger operations will also be executed at the same time.

How the product operates when triggers are used

When an ABOR command is received, INIT:TRAN is cancelled. The VOLT:TRIG value does not change.

The following table shows the responses when the voltage is set to 20 V (VOLT 20) and the voltage set by the trigger is 10 V (VOLT:TRIG 10).

	Response	
	VOLT?	VOLT:TRIG?
Immediately after the command is set	20 V	10 V
After the trigger is sent	10 V	10 V
After a *RST is sent	0 V	0 V
Voltage change VOLT 30 sent before the trigger is sent	30 V	30 V (cancel)

Measurement (ACQuire)

The ACQuire group is the measurement trigger subsystem. This subsystem is used to measure voltage, current, and power.

There are easy measurements and advanced measurements.

■ Simple measurement

This product has functions for returning the measured voltage, current, and power. The easiest measurement method is using the MEASure command.

The MEASure command starts a new measurement. Because this query starts a new measurement each time that it is sent, you cannot use it to synchronize the measurement of multiple items. The measurement method explained in “Advanced measurement” allows you to separate the measurement start operation and the data query operation.

Measuring the voltage and current

MEASure:VOLTage:ACDC? 'Queries the rms voltage

MEASure:CURRent:ACDC? 'Queries the rms current

MEASure:VOLTage:DC? 'Queries the average voltage

MEASure:CURRent:DC? 'Queries the average current

The current measurement function has the following additional parameters.

MEASure:CURRent:AMPLitude:MAXimum? 'Queries the peak current

MEASure:CURRent:AMPLitude:MAXimum:HOLD? 'Queries the peak current (the held value)

MEASure:CURRent:CREStfactor? 'Queries crest factor

MEASure:CURRent:AMPLitude:MAXimum:HOLD queries the maximum peak current after the product is turned on or after the peak current is cleared explicitly. Use the SENSE:CURRent:PEAK:CLEAr command to clear the peak current (the held value).

SENSe:CURRent:PEAK:CLEAr

The *RST or *RCL command does not clear the peak current (the held value).

Normally, it takes approximately 110 ms for a single measurement to complete. If you send the MEASure query multiple times, data acquisition will take a long time. If you want to acquire the data of multiple parameters, measure using the method explained

in “Advanced measurement.”

This product also supports the READ command, which starts a new measurement and queries the data. READ and MEASure are aliases. They operate exactly the same.

Power measurement

MEASure:POWer:ACDC? ‘Queries the AC power

MEASure:POWer:ACDC:APParent? ‘Queries the apparent power

MEASure:POWer:ACDC:REACTive? ‘Queries the reactive power

MEASure:POWer:ACDC:PFACTOR? ‘Queries the power factor

MEASure:POWer:DC? ‘Queries the average power

■ Advanced measurement

In advanced measurement, you can separate and control the starting of measurement and the referencing of data.

States

Trigger operation has three states: IDLE, INITiated, and WTG.

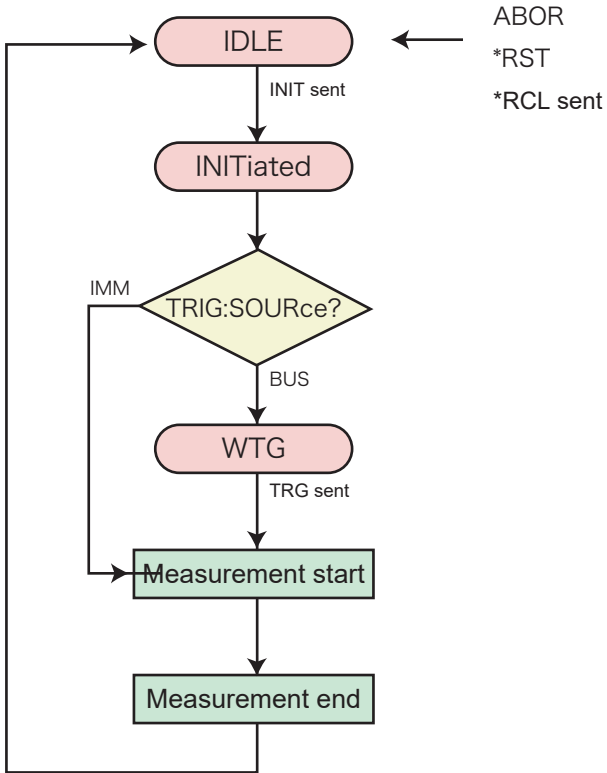

Measuring voltage, current, and power

To start a new measurement, set the trigger source to IMMEDIATE, and then use the INITIATE command.

```
TRIGGER:ACQUIRE:SOURCE IMMEDIATE 'Sets the trigger source to IMMEDIATE
INITIATE:ACQUIRE 'Initiates the ACQUIRE group
```

To use software triggers to start the measurement on the ACQUIRE group, change the trigger source to BUS.

```
TRIGGER:ACQUIRE:SOURCE BUS 'Sets the trigger source to BUS
INITIATE:ACQUIRE 'Initiates the ACQUIRE group
TRIGGER:ACQUIRE 'Applies a software trigger to the ACQUIRE group
```

When the measurement finishes, you can use the FETCH query to retrieve the measured data.

```
FETCH:VOLTAGE:ACDC? 'Queries the rms voltage
FETCH:CURRENT:ACDC? 'Queries the rms current
FETCH:POWER:ACDC? 'Queries the power
FETCH:POWER:ACDC:APPARENT? 'Queries the apparent power
```

If you send a FETCH command before the measurement is complete, correct measurement data will not be obtained.* By using the *OPC command, you can obtain correct measurement data.-> [“Waiting for Operation Complete”](#)(p. 348)

```
INITIATE:ACQUIRE;*OPC 'Initiates the ACQUIRE group and waits for the measurement to complete.
```

Use the TRIGGER:ACQUIRE:SOURCE command to set the trigger source to BUS or IMMEDIATE. INITIATE:ACQUIRE pulls the TRIGGER subsystem out of the IDLE state and starts (initiates) the trigger function.

If the trigger source is set to IMMEDIATE, the measurement starts immediately. If the trigger source is set to BUS, the TRIGGER subsystem enters the WTG (Waiting For Trigger) state. When a software trigger is received (through the TRIGGER:ACQUIRE command or *TRG command), the measurement starts. When the measurement finishes, the TRIGGER subsystem enters the IDLE state again. If the ABORT command or an equivalent command is received instead of a trigger, the measurement is canceled, and the TRIGGER subsystem returns to the IDLE state.

The `ABORt` command and IEEE488.1 `sdC/dcl` commands abort measurements that are in progress. These commands do not invalidate measured data that has already been retrieved. On the other hand, the `*RST` and `*RCL` common commands not only abort a measurement that is in progress but also invalidate the acquired measured data. If you send `*RST;:FETC:VOLT?`, an error will occur because there is no measured data that the `FETCh` query can retrieve and there is no new measurement that is going to be performed.

The difference between the `MEASure` (or `READ`) command and the `FETCh` command is as follows. The `MEASure` command starts a new measurement and then queries the measured data. The `FETCh` command queries the measured data without first starting a new measurement. The valid measurement parameters are exactly the same between `MEASure` and `FETCh`.

Power line abnormality simulations (SIMulation)

The SIMulation group is used to perform power line abnormality simulations.

■ Configuring parameters

First, configure the parameters.

```
SIMulation:T1:PHASe:STATe OFF 'Sets T1 using time
SIMulation:T5:CYCLe:STATe OFF 'Sets T5 using time
SIMulation:T1:TIME 5MS 'Sets the voltage regulation starting time
SIMulation:T2:TIME 10000MS 'Sets slope time 1
SIMulation:T3:TIME 100MS 'Sets the voltage regulation time
SIMulation:T3:VOLTage 50V 'Sets the regulated voltage
SIMulation:T4:TIME 10000MS 'Sets slope time 2
SIMulation:T5:TIME 10000MS 'Sets the return time
```

Next, set the number of repetitions.

```
SIMulation:REPeat:COUNT 5 'Sets the number of repetitions
```

After you have finished configuring the settings, execute the power line abnormality simulation.

■ Execute power line abnormality simulations.

Send the following command to execute a power line abnormality simulation.

```
OUTP ON
SIM:STAT RUN
```

You can query the execution status of power line abnormality simulations.

```
SIM:EXEC?
```

If the execution has been stopped, "STOP" is returned. If the sequence is being executed, "RUN" and the present repetition number is returned.

To stop a power line abnormality simulation that is being executed, send the following command.

```
SIM:STAT STOP
```

You can use triggers to execute power line abnormality simulations.

Execution using triggers

You can use triggers to synchronize power line abnormality simulations by using the

TRIGger:SIMulation subsystem.

Trigger operation has three states: IDLE, INITiated, and WTG.

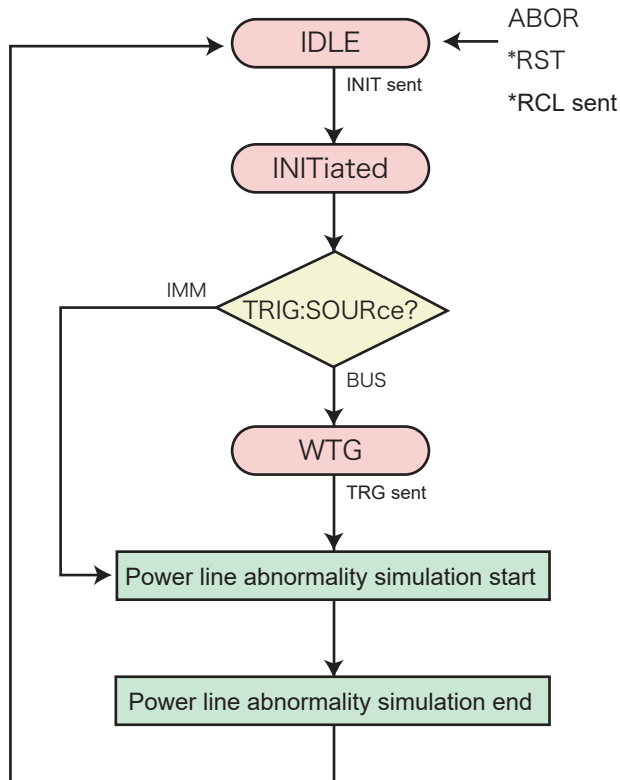

To start a simulation immediately, set the trigger source to IMMEDIATE, and then use the INITiate command.

TRIGger:SIMulation:SOURce IMMEDIATE 'Sets the trigger source to IMM

INITiate:SIMulation 'Initiates the SIMulation group. The power line abnormality simulation begins.

To use software triggers to start the power line abnormality simulation on the SIMulation group, change the trigger source to BUS.

TRIGger:SIMulation:SOURce BUS 'Sets the trigger source to BUS

INITiate:SIMulation 'Initiates the SIMulation group

TRIGger:SIMulation 'Applies a software trigger to the SIMulation group. The power line abnormality simulation begins.

Use the TRIGger:SIMulation:SOURce command to set the trigger source to BUS or IMMEDIATE. INITiate:SIMulation pulls the TRIGger subsystem out of the IDLE state and starts (initiates) the trigger function.

If the trigger source is set to IMMEDIATE, the power line abnormality simulation starts immediately. If the trigger source is set to BUS, the TRIGger subsystem enters the WTG (Waiting For Trigger) state. When a software trigger is received (through the TRIGger:SIMulation command or *TRG command), the power line abnormality simulation starts. When the simulation finishes, the TRIGger subsystem enters the IDLE state again. If the ABORt command or an equivalent command is received in the WTG state or when a simulation is being executed, the simulation is canceled, and the TRIGger subsystem returns to the IDLE state.

Send the *RST command to reset all the parameters of the power line abnormality simulation.

TRIGger:SIMulation:IMMEDIATE only applies a software trigger to the SIMulation group.

You can also use the *TRG command or the IEEE488.1 get (Group Execute Trigger) command for the same purpose. This command applies a software trigger to all trigger subsystems, if there are other trigger subsystems in the initiated state, their trigger operations will also be executed at the same time.

Sequence Operation (PROGram)

The PROGram group runs sequences.

■ Configuring step and sequence settings

First, configure the steps.

Use the PROG:EDIT command to set the number of the step that you want to configure, frequency signal change, frequency, AC voltage signal change, AC voltage, DC voltage signal change, DC voltage, step execution time, waveform bank number, status output, trigger output, trigger input, and whether output is ON or OFF.

```
PROG:Edit 1,OFF,50HZ,OFF,100V,OFF,0V,10S,0,OFF,ON,OFF,ON
```

```
PROG:Edit 2,OFF,60HZ,ON,200V,OFF,0V,1MIN,1,OFF,OFF,OFF,ON
```

```
PROG:Edit 3,ON,400HZ,ON,230V,OFF,50V,1HR,2,ON,OFF,OFF,ON
```

Next, configure the sequence conditions.

```
PROG:STEP:START 1 'Sets the starting step number
```

```
PROG:STEP:END 3 'Sets the ending step number
```

```
PROG:LOOP 10 'Sets the number of repetitions
```

After you have finished configuring the sequence, execute it.

■ Executing sequences

Send the following command to execute a sequence.

```
PROG:STAT RUN
```

You can query the execution state of the sequence.

```
PROG:EXEC?
```

The execution state—STOP (stopped), RUN (running), or PAUSE (paused), elapsed step time, present repetition number, and step number are returned as a comma-separated list.

To stop a sequence that is being executed, send the following command.

```
PROG:STAT STOP
```

You can use triggers to execute sequences.

Execution using triggers

You can use triggers to synchronize sequences by using the TRIGger:PROGram sub-

system.

A sequence has three states: IDLE, INITiated, and WTG.

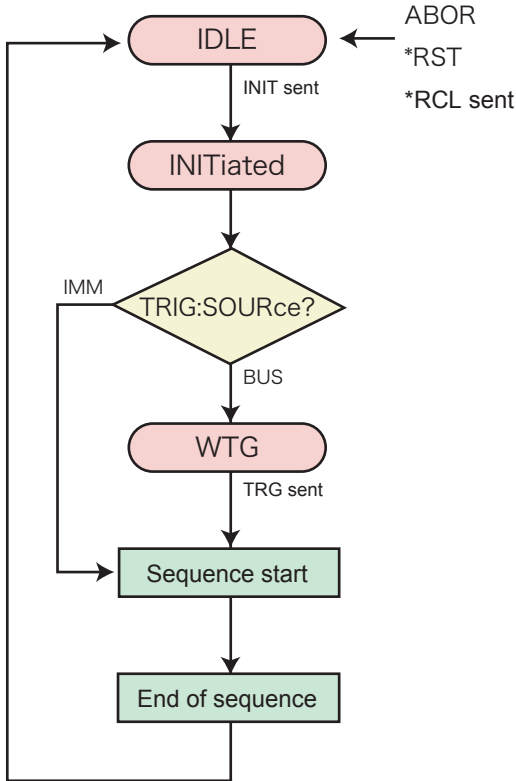

To start a sequence immediately, set the trigger source to IMMEDIATE, and then use the INITiate command.

TRIGger:PROGram:SOURce IMMEDIATE 'Sets the trigger source to IMM

INITiate:PROGram 'Initiates the PROGram group. The sequence begins.

To use software triggers to start the sequence on the PROGram group, change the trigger source to BUS.

TRIGger:PROGram:SOURce BUS 'Sets the trigger source to BUS

INITiate:PROGram 'Initiates the PROGram group

TRIGger:PROGram 'Applies a software trigger to the PROGram group. The sequence begins.

Use the TRIGger:PROGram:SOURce command to set the trigger source to BUS or

IMMediate. INITiate:PROGrama pulls the TRIGger subsystem out of the IDLE state and starts (initiates) the trigger function.

If the trigger source is set to IMMediate, the sequence starts immediately. If the trigger source is set to BUS, the TRIGger subsystem enters the WTG (Waiting For Trigger) state. When a software trigger is received (through the TRIGger:PROGrama command or *TRG command), the sequence starts. When the sequence finishes, the TRIGger subsystem enters the IDLE state again. If the ABORt command or an equivalent command is received in the WTG state or when a sequence is being executed, the sequence is canceled, and the TRIGger subsystem returns to the IDLE state.

TRIGger:PROGrama:IMMediate only applies a software trigger to the PROGrama group.

You can also use the *TRG command or the IEEE488.1 get (Group Execute Trigger) command for the same purpose. This command applies a software trigger to all trigger subsystems, if there are other trigger subsystems in the initiated state, their trigger operations will also be executed at the same time.

When all the PROGrama processes are complete, the product's settings are those of the last step.

If the output is on in the last step of the sequence, the output will remain on when the sequence is completed.

Waiting for Operation Complete

The *OPC command has a function for waiting for operations to complete. Operation complete means that there are no operations that are waiting for a response from the PCR-WEA. Measurement completion requires about 110 ms. The PCR-WEA is not in the operation complete state while a measurement is ongoing. When the measurement completes, if there are no other operations waiting to be completed, the PCR-WEA enters the operation complete state.

When an *OPC command is received, the product transitions to the Operation Complete Command Active State (OCAS). If a measurement is completed and there are no operations standing by, the product returns to the Operation Complete Command Idle State (OCIS) and sets the OPC bit (bit 0) of the event status register to TRUE (1). This information can be determined by checking the OPC bit (bit 0) of the *ESR? query.

Next, we will show an example that starts a new measurement and sends an *OPC command. Because the event status enable register and service request enable register are configured to generate a service request (SRQ) in response to an operation complete event, an SRQ is generated when a measurement is completed. The SRQ function cannot be used if you are using the RS232 interface.

```
*ESE 1;*SRE 32;*CLS;:INITiate:IMMEDIATE:ACQUIRE;*OPC  
<Generates a service request>
```

If you use the *OPC? query command in place of the *OPC command, the product transitions to the Operation Complete Query Active State (OQAS). If a measurement is completed and there are no operations standing by, the product returns to the Operation Complete Query Idle State (OQIS) and sets response data "1" (in NR1 format) in the output queue.

```
INITiate:IMMEDIATE:ACQUIRE;*OPC?  
<Reads the response>
```

At power-on, if you send an IEEE488 sdc/dcl, *RST, or *RCL, this product switches to the OCIS and OQIS states.

Status Monitoring

The product has two mandatory SCPI standard registers, STATus:OPERation and STATus:QUEStionable, in addition to the IEEE488.2 standard registers.

■ Register basics

All SCPI registers have a standard architecture that uses events/filters. CONDition, EVENT, and ENABLE and optionally PTRansition and NTRansition can be used. CONDition and EVENT are read-only registers working as status indicators. ENABLE, PTRansition and NTRansition are read-write registers working as event and summary filters.

■ STATus:OPERation

The OPERation Status register is used to record events and notifications that occur during normal operations.

To check whether CV output is being performed, check the CV bit (bit 8) of the STATus:OPERation register.

STATus:OPERation? 'Checks whether the CV bit is set.

■ STATus:QUEStionable

The QUEStionable Status register is used to record events and notifications that occur during abnormal operations.

To check whether a protection function has been activated, check the OV bit (bit 0) of the STATus:QUEStionable register.

STATus:QUEStionable? 'Checks whether the OV bit is set.

■ Monitoring status for single-phase three-wire output and three-phase output

STATus:OPERation

The OPERation Status register is used to record events and notifications that occur during normal operations.

To check whether CV output is being performed, check the CV bit (bit 8) of the STATus:OPERation:INSTrument:ISUMmary{1|2|3} subregister.

Of the parameters {1|2|3}, 1 represents U phase, 2 represents V phase, and 3 represents W phase.

STAT:OPER:INST:ISUM2? 'Check whether the CV bit of the V phase is set.

STATus:QUESTionable

The QUESTionable Status register is used to record events and notifications that occur during abnormal operations.

To check whether the overvoltage protection function has been activated, check the OV bit (bit 0) of the STATus:QUESTionable register.

STAT:QUES? 'Check whether the OV bit is set.

Even if bit 0 is true, you cannot tell on which phase the overvoltage protection function has been activated. To check which phase is operating abnormally, check the STATus:QUESTionable:INSTrument subregister.

STAT:QUES:INST? 'Check which phase is operating abnormally.

All channels whose corresponding bits are true are operating abnormally. You can determine how the specified phase is operating abnormally by checking the STATus:QUESTionable:INSTrument:ISUMmary{1|2|3} subregister of the channel.

Of the parameters {1|2|3}, 1 represents U phase, 2 represents V phase, and 3 represents W phase.

STAT:OPER:INST:ISUM2? 'Check whether the OV bit of the V phase is set.

■ PON (Power ON) bit

The PON bit (bit 7) of the event status register is always set when the product is turned on. To generate a power-on SRQ to track power failures and power supply line errors, use PON as follows.

1

Set *PSC (Power-on Status Clear) to 0 (or OFF).

Enable the backup functions for event status enable register and service request enable register settings. (*PSC 0)

2

Set the PON bit (bit 7) of the event status enable register.

This enables the transmission of power-on events to the higher layer. (*ESE 128)

3

Set the ESB bit (bit 5) of the status byte enable register.

This enables the generation of SRQs based on standard events. (*SRE 32)

*PSC 0;*ESE 128;*SRE 32

When you use the RS232C interface, the PON bit cannot be assigned to a service request because SRQs are not generated.

When you use the USB or LAN (VXI-11/HiSLIP) interface, even though the SRQ function itself is supported by the communication protocol, a connection lost error occurs in the VISA I/O session immediately before the power-on event. It appears that handling PON events would be difficult.

Error Checking

■ Error/event queue

The SCPI specifications define a standard error reporting scheme, Error/Event Queue. This is a FIFO (First In First Out) queue, which records errors and events. The maximum number of errors/events that the product can record is 16. Each error/event can be read with the SYSTem:ERRor query.

```
SYSTem:ERRor?
```

The response to this query contains a numeric part (error/event number) and a textual description, such as:

```
-222,"Data out of range"
```

The error/event queue becomes empty when the *CLS common command is sent, when the last item in the queue is read, and when the product is turned on. When the error/event queue is empty, the query returns the following:

```
0,"No error"
```

■ Displaying communication errors

The product has a debug trace function.

The product can display the oldest item among the errors and events (if there are errors or events). This is convenient for debugging remote control.

When an error or event item is displayed on the panel, the normal voltmeter and ammeter are void.

When the error/event queue is empty, the debug trace function does not display communication errors.* When you send a CLS command, the communication error display clears.

In local mode, the debug trace function is temporarily disabled.

Visual Basic 2017

■ Configuring a project

First, add the communication middleware (VISA library) to the project.

Click References on the Project menu to open the Reference Manager window.

On the navigation pane, click COM and then Type Libraries.

From the list in the center of the window, select “VISA COM *.* Type Library” (where *.* is the VISA library version number), and select the check box.

Click OK to close the dialog box.

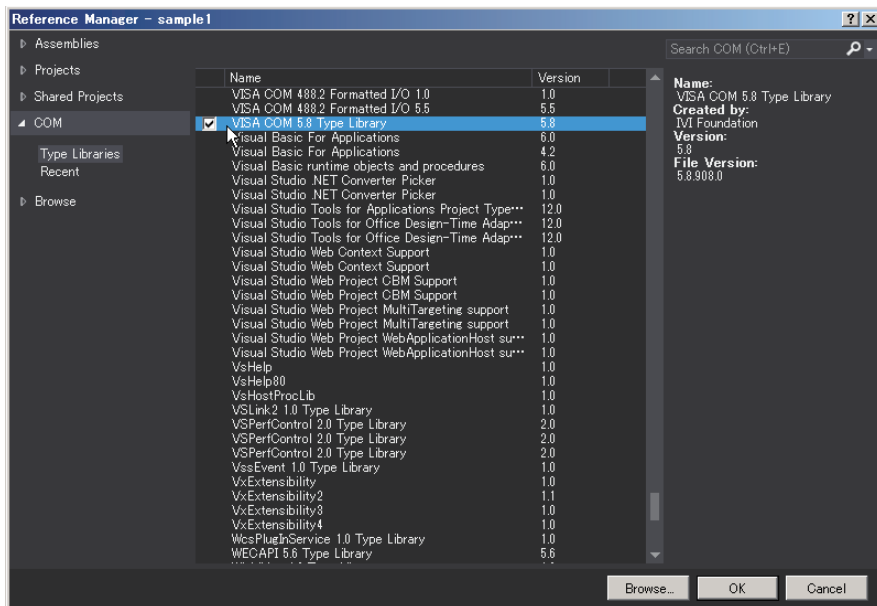

■ Communicating via GPIB, RS232C, USB, or LAN

Opening VISA

Before you can use the VISA library to communicate with GPIB, RS232C, USB, and LAN devices, you have to open VISA. Specify an I/O resource to open VISA.

Example: Opening VISA when using USB on the PCR-WEA

```
Set rm = CreateObject("VISA.GlobalRM")
```

```
Set msg = rm.Open("USB::0x0B3E::0x104E::00000001::INSTR", NO_LOCK, 0, "")
```

"USB::0x0B3E::0x104E::00000001::INSTR" is an I/O resource.

The I/O resource syntax is shown below. The parts surrounded by square brackets ([]) can be omitted. Enter the appropriate values in the parts written in italics.

GPIB	GPIB[<i>board</i>]::PrimaryAddress[::SecondaryAddress][::INSTR] Example: Measuring instrument with primary address 3 connected to GPIB0 GPIB0::3::INSTR
Serial (RS232C)	ASRL[<i>board</i>][::INSTR] Example: A measuring instrument connected to serial port COM1 ASRL1::INSTR
USB	USB[<i>board</i>]::VendorID::ProductID::SerialNumber[::InterfaceNumber][::INSTR] Example: A USBTMC measuring instrument whose vendor ID (VID) is 2878, product ID (PID) is 4174, and serial number is 00000001 USB0::0x0B3E::0x104E::00000001::INSTR
LAN ^{*1}	VXI-11 TCPIP[<i>board</i>]::hostname[::inst0][::INSTR] Example: Measuring instrument whose IP address (hostname) is 169.254.7.8 TCPIP::169.254.7.8::INSTR You can also specify the host name for the hostname parameter.
	HiSLIP TCPIP[<i>board</i>]::hostname::hislip0[::INSTR] Example: Measuring instrument whose IP address (hostname) is 169.254.7.8 TCPIP::169.254.7.8::hislip0::INSTR You can also specify the host name for the hostname parameter.
	SCPI-RAW TCPIP[<i>board</i>]::hostname::portno::SOCKET Example: Measuring instrument whose IP address (hostname) is 169.254.7.8 (the product's port number is fixed to 5025) TCPIP::169.254.7.8::5025::SOCKET You can also specify the host name for the hostname parameter.

*1: The hostname must be a valid mDNS hostname (a Bonjour hostname that ends in ".local") or a DNS hostname that is managed by an external DNS server (a full-qualified domain name—

FQDN). If you are using an mDNS hostname, Apple Bonjour (alternatively, iTunes or Safari) must be installed on your PC.

In VISA, you can use aliases for I/O resources.

If you use an alias for an I/O resource, even if the alias name is hard-coded in the application, the I/O resource name can still be changed to an appropriate value when the application runs.

Example: Using an alias (MYDEV1) for an I/O resource

```
Set msg = rm.Open("MYDEV1", NO_LOCK, 0, "")
```

When you use aliases, specify the actual I/O resources through an external configuration table or similar tool. Refer to the VISA manual.

Controlling the instrument

Next, we will use commands such as read and write commands to control the instrument. You must include line-feed codes in the command strings.

Examples:

```
msg.WriteString ("VOLT 110" & vbLF) 'Sets the AC voltage to 110 V
msg.WriteString ("FREQ 60" & vbLF)  'Sets the frequency to 60.0 Hz
msg.WriteString ("OUTP 1" & vbLF)  'Turns the output on
```

Closing VISA

Finally, close VISA.

In a sequence of operations, you only have to open and close VISA once.

```
msg.Close
```

■ Sample program

```
Imports Ivi.Visa.Interop
```

```
Public Class Form1
```

```
Dim rm As ResourceManager
```

```
Dim msg As IMessage
```

```
Sub Form1_Load(ByVal sender As System.Object, ByVal e As System.EventArgs) Handles MyBase.Load
```

```
rm = CreateObject("VISA.GlobalRM")
```

```
msg = rm.Open("USB0::0x0B3E::0x104E::00000001::INSTR", AccessMode.NO_LOCK, 0, "")
```

'Version using a VISA alias

```
'msg = rm.Open("MYDEV1", AccessMode.NO_LOCK, 0, "")
```

'Version using LAN (SCPI-RAW)

```
'msg = rm.Open("TCPIP::169.254.7.8::5025::SOCKET", AccessMode.NO_LOCK, 0, "")
```

'Version using GPIB

```
'msg = rm.Open("GPIB0::1::INSTR", AccessMode.NO_LOCK, 0, "")
```

```
msg.TerminationCharacterEnabled = True
```

End Sub

'Query the ID

```
Private Sub Button1_Click(ByVal sender As System.Object, ByVal e As System.EventArgs) Handles Button1.Click
```

```
msg.WriteString("SYST:COMM:RLST REM" & vbCrLf)
```

```
msg.WriteString("**IDN?" & vbCrLf)
```

```
TextBox1.Text = msg.ReadString(256)
```

End Sub

'Set the voltage, frequency, and output.

```
Private Sub Button2_Click(ByVal sender As System.Object, ByVal e As System.EventArgs) Handles Button2.Click
```

```
msg.WriteString("OUTP 0" & vbCrLf)
```

```
msg.WriteString("VOLT 110" & vbCrLf)
```

```
msg.WriteString("FREQ 60" & vbCrLf)
```

```
msg.WriteString("OUTP 1" & vbCrLf)
```

End Sub

'Queries the measured voltage

```
Private Sub Button3_Click(ByVal sender As System.Object, ByVal e As System.EventArgs) Handles Button3.Click
```

```
msg.WriteString("MEAS:VOLT:AC?" & vbCrLf)
```

```
TextBox1.Text = msg.ReadString(256)
```

End Sub

```
Private Sub Form1_Disposed(ByVal sender As Object, ByVal e As System.EventArgs) Handles Me.Disposed
```

```
msg.Close()
```

End Sub

End Class

KIKUSUI ELECTRONICS CORP.

1-1-3 Higashiyamata, Tsuzuki-ku, Yokohama,
224-0023, Japan
Tel: +81-45-482-6353 Fax: +81-45-482-6261



www.kikusui.co.jp/en